

BEX SPRAY NOZZLES • CATALOG NO.

60



WELCOME TO BEX SPRAY NOZZLES

With over 50 years of design and manufacturing experience, BEX is a leader in spray nozzle and tank mixing educator technology. Our sales specialists, engineers, and technical support staff are capable and willing to help solve the toughest of application problems in industries ranging from cleaning, rinsing, and washing to food and beverage, from chemical processes to dust control, and many more.

Innovative Design and Flexibility of Use

BEX's commitment to innovation has made us an industry leader. At BEX we are constantly expanding and improving our product line. This catalog shows the most popular of spray nozzles and tank mixing educator products. However, BEX also makes a wide range of specialty products to each customer's own demanding specifications.

BEX is known not just for our exceptional quality, but also for our industry leading delivery and customer service.

Featured Products:



This catalog lists the most popular models of BEX spray nozzles and accessories. Many others are available, often in special materials. PLEASE NOTE THAT SPECIFICATIONS ARE SUBJECT TO CHANGE WITHOUT NOTICE.

$$\frac{\text{Flow A}}{\text{Flow B}} = \sqrt{\frac{\text{Pressure A}}{\text{Pressure B}}}$$

DESIGN AND ENGINEERING INFORMATION

- Nozzle selection
- Technical information
- Conversion factors
- Preventing Nozzle Problems
- Common Causes of Nozzle Problems

THREADED NOZZLES

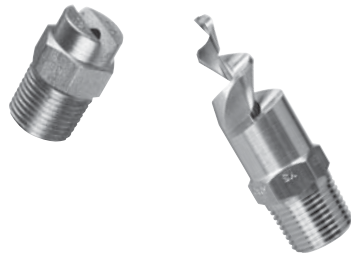

Includes:

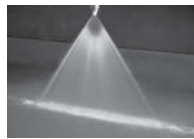

Flat Spray

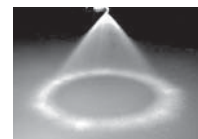

Hollow Cone

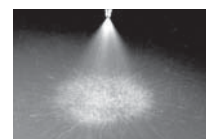

Full Cone

And much more.

QUICK DISCONNECT

Including BEX Zip-Tip and K-Ball Clip-On Nozzles



OTHER TYPES OF NOZZLES

- Includes: Industry specific nozzles
- Rotating nozzles
- Accessories
- Much more

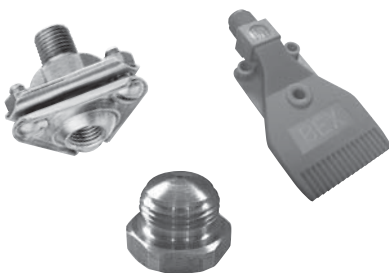

AIR ATOMIZING

- Includes: Various spray set-ups
- Connection types
- Extensions
- Much more



For a detailed listing of parts please see the index on page 102.

Selection Guide

This section describes some of the questions to be considered when selecting spray nozzles. In addition, answers for uncomplicated situations are provided where possible. In some applications, because of the large number of variables involved, accurate answers are not always possible except through actual testing or simulation. Our technical staff, however, may be able to lend assistance in their areas of expertise. Please feel free to give us a call.

WHAT SPRAY NOZZLE CONSTRUCTION DO I REQUIRE?

The basic elements of spray nozzle construction are assembly configuration, spray pattern, flow rate, connection size, physical dimensions, and material of construction.

ASSEMBLY CONFIGURATION refers to the mechanical style of the nozzle, It could be a pipe thread, a clip-on nozzle, or a nozzles that has no thread at all, such as nozzles with flanges. This aspect of nozzle selection is often determined by the industry or application.

PIPE CONNECTION is described by type, size, male, female, or flange. Nozzles described in this catalog have NPT threaded pipe connections (BSPT are also available for most models).

SIZE - Standard sizes from 1/8 NPT to 4" NPT, or as indicated.

MALE AND FEMALE connections are available where indicated.

The images on page 5 will help you determine the size of each specified pipe thread. Please note that the name of the thread, for example 1/4, does not refer to the threads actual dimensions.

PHYSICAL DIMENSIONS are listed throughout this catalog for each specific style of nozzle.

MATERIAL OF CONSTRUCTION

Standard materials are available as noted in this catalog. In addition, many models are available in special materials. Our technical staff will be pleased to discuss your special material requirements with you. BEX nozzles have been produced in the following materials:

Materials	Material Codes
Brass	B
Steel/Cast Iron	I
303 Stainless Steel	3
316 Stainless Steel	6
316L	R
Hastelloy®	E
Titanium	N
Monel®	O
Carpenter 20®	C
PVC	V
CPVC	A
Glass Reinforced Polypropylene (GRP)	L
	LL (molded green)
	LN (molded natural)
PVDF/Kynar	K
	KK (molded red)
	KN (molded natural)
Teflon	T

WHAT TYPE OF CONNECTION DO I REQUIRE?

BEX spray nozzles are available in many different connection styles. The most common connection types depend on the industry where the nozzles are being used. Generally, however, the most common connection is the standard tapered, or NPT, pipe thread. The outside diameters of NPT threads are shown below. Most BEX nozzles are also available with BSPT threads. The chart below can also be used for those.

Other common connections include the quick disconnect style, or BEX Zip-Tip®, which is a bayonette style of connection whereby a tip is inserted into a threaded body, and the BEX clip-on K-Ball® series, which is a style of nozzle which connects to a pipe by means of a heavy duty stainless steel clip and eliminates the need for threaded connectors.

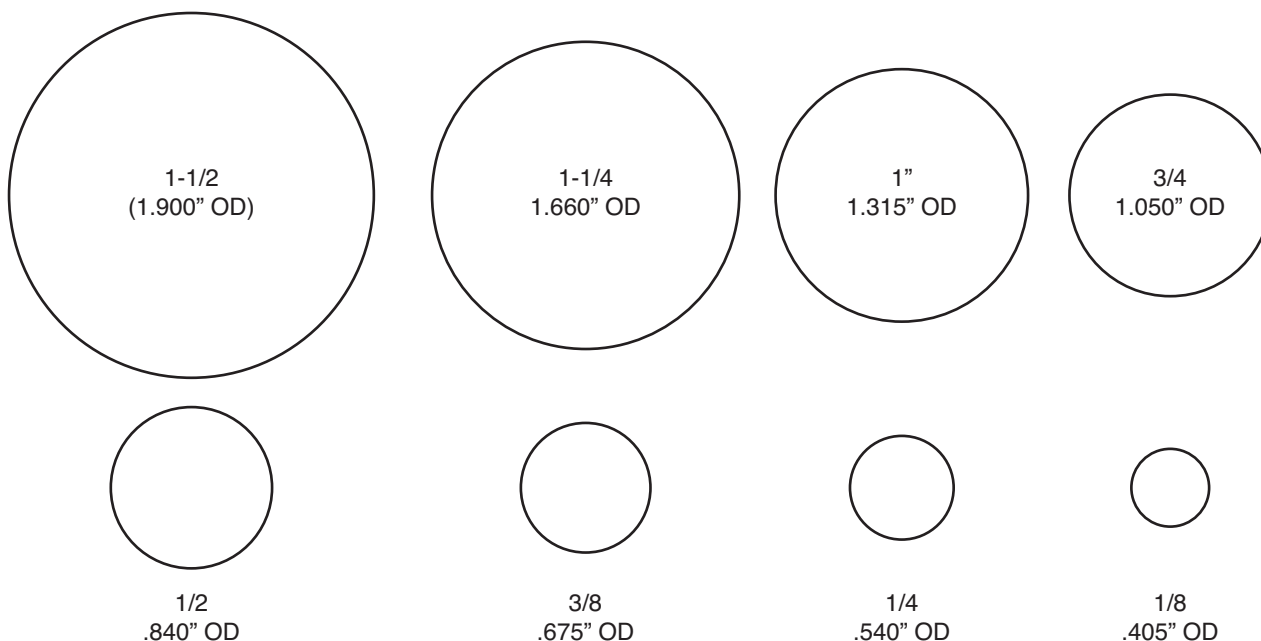

WHAT SPRAY CHARACTERISTICS DO I REQUIRE?

A spray may be characterized by describing its spray pattern, flow rate, atomization and spray angle. This catalog describes these characteristics for the listed nozzles, for spraying water under controlled conditions.

SPRAY PATTERN: Common spray patterns (flat, full cone, hollow cone) are all described in this catalog. The spray pattern of a nozzle will generally travel further under higher fluid pressures. However, fine mist-like sprays are very susceptible to air movement, and may be carried away by such movement of air.

FLOW RATE: The flow rates listed in this catalog are for water in U.S. gallons per minute, unless otherwise indicated. "--" in the capacity table means "not recommended at this pressure."

ATOMIZATION: Atomization is primarily dependent on pressure and viscosity, and varies from point to point within a spray pattern. A range of particle sizes is produced, with some average value which varies according to conditions. For this reason, spray droplet sizes are not listed in this catalog. If you require spray droplet information for critical applications, BEX will be pleased to provide you with measurements, using our in-house laser doppler anemometry equipment.

SPRAY ANGLES: The spray angles listed in this catalog are for water spray under controlled conditions. Under low pressure, the sides of the spray may curve due to the acceleration of gravity. Spray angles may also be reduced due to the tendency of spray patterns to interfere with themselves or with spray patterns from adjacent nozzles. Table 1 on page 7 lists theoretical spray coverage for a variety of spray angles at various distances from the nozzle.

WHAT FACTORS WILL AFFECT MY SPRAY CHARACTERISTICS?

When the conditions controlling spray nozzle performance change, the spray characteristics may change. This section lists conditions which may vary, and how those conditions may affect the spray characteristics.

PRESSURE: The flow rate of a liquid is proportional to the square root of the pressure difference between the pressure liquid and external (usually atmospheric) conditions, thus higher pressure generally results in finer spray atomization, greater spray impact, and greater spraying distance.

$$\frac{\text{Flow A}}{\text{Flow B}} = \frac{\sqrt{\text{Pressure A}}}{\sqrt{\text{Pressure B}}}$$

VISCOSITY: Spraying liquids with higher viscosity than water generally results in reduced atomization, and impact. Spray angle will usually decrease.

SPECIFIC GRAVITY: Flow rates shown in this catalog are for water. (The specific gravity of water is 1.0). For liquids with a different specific gravity, flow is given by the formula:

$$\text{Flow} = \text{Water Flow} \times \frac{1}{\sqrt{\text{Spec. gravity}}}$$

SURFACE TENSION: An increase in surface tension generally results in an increase in spray droplet size, and a reduction in spray angle.

SPRAY DROP SIZE (Atomization)

One Inch = 25,400 Microns

- 500 Microns
- 1,200 Microns
- 5,500 Microns

IMPACT

Spray impingement, or "spray impact" as it is otherwise known, can be calculated using several different methods. The most widely used value with regards to nozzle performance is "impact per square inch." However, it is dependent on spray pattern and spray angle. In order to calculate the impact per square inch for a given nozzle, you must first determine the theoretical total impact using the formula below:

Next, using the chart to the right, find the relevant Percent Impact per sq. in of the theoretical total impact and multiply this by the theoretical total. The result of this equation is the spray impact in pounds per square inch. The greatest impact in pounds per square inch is attained by solid stream nozzles and can be calculated using the formula:

$$1.9 \times (\text{spraying pressure, psi})$$

Theoretical Total Impact Spraying Water (pound-force) =

$$.0526 \times (\text{gpm at spraying pressure}) \times \sqrt{\text{spraying pressure, psi}}$$

Spray Pattern Type	Spray Angle	Percent Impact per sq. in. of Theoretical Total Impact
Flat Fan	15°	30%
	25°	20%
	35°	15%
	40°	12%
	50°	10%
	65°	7%
	80°	5%
Full Cone	15°	10%
	30°	2%
	50°	1%
	65°	0.5%
	80°	0.2%
	100°	0.1%
Hollow Cone	70°	1.5%

At a distance of 12" from nozzle.

INCLUDED SPRAY ANGLE	W/D RATIO	Theoretical coverage (W) at various distances (D) from the nozzle											
		Distance (D) inches											
		2	3	4	6	8	12	16	24	34	48		
5°	0.087	0.2	0.3	0.3	0.5	0.7	1.0	1.4	2.1	3.0	4.2	5.9	8.4
10°	0.175	0.3	0.5	0.7	1.0	1.4	2.1	2.8	4.2	5.9	8.4	12.0	16.9
15°	0.263	0.5	0.8	1.1	1.6	2.1	3.2	4.2	6.3	9.0	12.6	16.9	21.3
20°	0.353	0.7	1.1	1.4	2.1	2.8	4.2	5.6	8.5	12.0	16.9	21.3	25.7
25°	0.443	0.9	1.3	1.8	2.7	3.5	5.3	7.1	10.6	15.1	21.3	25.7	30.3
30°	0.536	1.1	1.6	2.1	3.2	4.3	6.4	8.6	12.9	18.2	25.7	30.3	34.9
35°	0.631	1.3	1.9	2.5	3.8	5.0	7.6	10.1	15.1	21.4	30.3	34.9	39.8
40°	0.728	1.5	2.2	2.9	4.4	5.8	8.7	11.6	17.5	24.7	34.9	39.8	45
45°	0.828	1.7	2.5	3.3	5.0	6.6	9.9	13.3	19.9	28.2	39.8	45	50
50°	0.933	1.9	2.8	3.7	5.6	7.5	11.2	14.9	22.4	31.7	45	50	55
55°	1.04	2.1	3.1	4.2	6.2	8.3	12.5	16.7	25.0	35.4	50	55	61
60°	1.15	2.3	3.5	4.6	6.9	9.2	13.9	18.5	27.7	39.3	55	61	67
65°	1.27	2.5	3.8	5.1	7.6	10.2	15.3	20.4	30.6	43	61	67	74
70°	1.40	2.8	4.2	5.6	8.4	11.2	16.8	22.4	33.6	48	67	74	81
75°	1.53	3.1	4.6	6.1	9.2	12.3	18.4	24.6	36.8	52	74	81	88
80°	1.68	3.4	5.0	6.7	10.1	13.4	20.1	26.9	40	57	81	88	96
85°	1.83	3.7	5.5	7.3	11.0	14.7	22.0	29.3	44	62	88	96	105
90°	2.00	4.0	6.0	8.0	12.0	16.0	24.0	32.0	48	68	96	105	114
95°	2.18	4.4	6.5	8.7	13.1	17.5	26.2	34.9	52	74	105	114	137
100°	2.38	4.8	7.2	9.5	14.3	19.1	28.6	38.1	57	81	114	137	166
110°	2.86	5.7	8.6	11.4	17.1	22.9	34.3	46	69	97	137	166	206
120°	3.46	6.9	10.4	13.9	20.8	27.7	42	55	83	118	166	206	264
130°	4.29	8.6	12.9	17.2	25.7	34.3	51	69	103	146	206	264	358
140°	5.49	11.0	16.5	22.0	33.0	44	66	88	132	187	264	358	
150°	7.46	14.9	22.4	29.9	45	60	90	119	179	254	358		

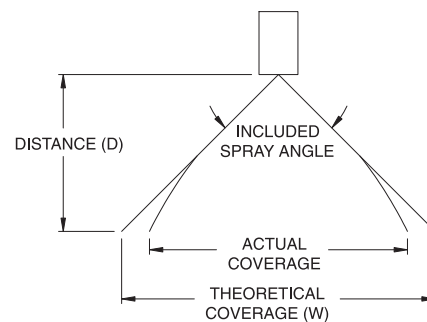

Spray coverages shown in Table 1 are based on straight sided spray patterns. At low pressures the sides may curve in, as shown at the right, because of the acceleration due to gravity.

To find the width of a spray (W) at any distance (D), multiply the W/D ratio by the distance.

OTHER TRADEMARKS FOUND IN THIS CATALOGUE:

- BEX® is a registered trademark of BEX
- K-Ball® is a registered trademark of BEX
- Twister® is a registered trademark of BEX
- ZIP-TIP® is a registered trademark of BEX
- Hastelloy® is a registered trademark of Haynes International, Inc.
- Carpenter 20® is a registered trademark of Carpenter Technologies
- Monel® is a registered trademark of The International Nickel Company, Inc.
- Teflon® is a registered trademark of E.I. DuPont de Nemours and Company
- Kynar® is a registered trademark of Atochem North America, Inc.
- Viton® is a registered trademark of E.I. DuPont de Nemours and Company
- TWK Patent No. 5,316,218
- ZIP-TIP Patent No. 5,421,522 – other patents pending

Monitor Nozzle Performance

Flow rate

Flow rate can be measured by connecting a flowmeter in series with the nozzle, or collecting the output from the nozzle in a container of known volume over a measured period of time. If the flow rate is higher than the nozzle specifications then it is possible that the orifice has partially corroded or eroded away. If the flow rate is lower than specified then the nozzle could be clogged or caked. Such problems are often accompanied by a change in spray pattern or distribution.

Pressure

A decrease in your system pressure could indicate excessive nozzle wear, due to corrosion or erosion. An increase in pressure could indicate clogging of your spray nozzles.

Distribution

All nozzles have a specified spray pattern, distribution, and spray angle. If any one of these is not as you expect it could indicate that the nozzles are worn or clogged.

Finished Product Quality

Sometimes nozzles are difficult to see while in use because they are in enclosed systems which are difficult to monitor. If the products coming out of these systems, such as a washer, are not as expected, it could indicate that the nozzles are not performing as expected. A closer inspection is recommended.

Methods to Maintain Peak Performance and Reduce Potential Problems

Alternative Materials

Some materials are better suited than others for certain applications. The incorrect material can wear very quickly due to both corrosion and erosion, given the proper chemicals, temperature, or pressure. If this is the case you should check with your chemical supplier or system designer to determine the best possible nozzle material.

Clean Nozzles Regularly

Regular nozzle inspection will help identify nozzles which need cleaning. Be careful to clean nozzles only with soft tools or the orifice or other important edges and surfaces could be damaged. Remember, however, that a new nozzle will perform better than a cleaned nozzle and could save thousands of dollars.

Change Nozzle Type or Size

If the same problems keep occurring then a change in the style of nozzle might be the best solution.

Decrease Operating Pressures or Temperatures

Higher operating pressures can result in higher wear. With plastic nozzles temperature can also have a significant effect on nozzle life. While your process may require such operating conditions, it may also be possible that either pressure or temperature could be reduced.

Reduce Amount of Abrasives in the System

Nozzles will often wear out prematurely as a result of excessive abrasion. Without proper filtration a system may have unexpected abrasives in the fluids which cause excessive wear on not just the spray nozzles but also piping and pumps.

There are thousands of different spray nozzles to choose from. If the incorrect nozzle is chosen for your application then problems could arise. Furthermore, nozzles can develop problems under normal use. Below is a list of some of the more common problems which can arise.



Corrosion

The nozzle degrades due to chemical reactions between the nozzle material and the chemicals in the process.



Temperature

If nozzles are subjected to temperatures greater than recommended then physical damage can occur.



Erosion/Wear

As fluid passes through the orifice and internal passages of the nozzle the critical surfaces can become worn, thereby creating a poor spray.

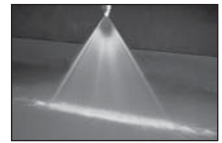

Clogging

Many chemical compounds and particles larger than the maximum free passage of the nozzle will clog the nozzle.



Caking

Many chemicals will slowly build up on the nozzle surfaces and restrict the flow or otherwise prevent correct operation and performance.



Mechanical Damage

Cross threading, over tightening, and stripping the hex are just some examples of ways a spray nozzle can be damaged. Spray nozzles in this condition will usually need replacing.



Incorrect Assembly

Care must be taken when reassembling a nozzle. Internal components must be installed correctly or the result will be an bad spray.



Low Flow Rate

If the flow rate is lower than expected then make sure that there are no significant pressure losses between the pump and the nozzle. Measuring pressure right at the nozzle is the most accurate method.



Conversion Factors

USEFUL CONVERSION FACTORS:

Volume	1 U.S. gallon = 3.785 litre = 0.1337 ft ³ = .003785 m ³ 1 ft ³ = 0.02832 m ³ = 7.48 U.S. gallons
Pressure	1 psi = 6895 N/m ² = 6895 Pa = .069 bar = .069 Kg/cm ² 1 in Hg = 25.4 mm Hg = .4912 psi = 3386 N/m ² 1 in H ₂ O = 25.4 mm H ₂ O = .0361 psi = 249.1 N/m ² 1 atmosphere = 14.7 psi = 29.92 in Hg = 760 mm Hg = 101.325 kN/m ² 1 bar = 14.504 psi = 100 kN/m ² = 1.02 Kg/cm ² 1 foot head (water) = .433 psi
Flow rate	1 U.S. gallon per minute = 0.1337 ft ³ /min = 3.785 l/min 1 ft ³ /sec = .02832 m ³ /sec = 28.32 l/sec
Length	1 in = 25.4 mm 1 ft = .3048 m 1 mile = 1.609 km

TABLE OF EQUIVALENTS

Volumetric Unit	VOLUMETRIC UNITS – EQUIVALENTS						
	Cubic Centimeter	Fluid Ounce	Pound of Water	Liter	US Gallon	Cubic Foot	Cubic Meter
Cubic Centimeter	•	0.034	2.2x10 ⁻³	0.001	2.64x10 ⁻⁴	3.53x10 ⁻⁵	1.0x10 ⁻⁶
Fluid Ounce	29.4	•	0.065	0.030	7.81x10 ⁻³	1.04x10 ⁻³	2.96x10 ⁻⁵
Pound of Water	454	15.4	•	0.454	0.12	0.016	4.54x10 ⁻⁴
Liter	1,000	33.8	2.2	•	0.264	0.035	0.001
US Gallon	3,785	128	8.34	3.785	•	0.134	3.78x10 ⁻³
Cubic Foot	28,320	958	62.4	28.3	7.48	•	0.028
Cubic Meter	1.0x10 ⁶	3.38x10 ⁴	2202	1000	264	35.3	•

Linear Unit	LINEAR UNITS – EQUIVALENTS						
	Micron	Mil	Millimeter	Centimeter	Inch	Foot	Meter
Micron	•	0.039	0.001	1.0x10 ⁻⁴	3.94x10 ⁻⁵		
Mil	25.4	•	2.54x10 ⁻²	2.54x10 ⁻³	0.001	8.33x10 ⁻⁵	
Millimeter	1000	39.4	•	0.10	0.0394	3.28x10 ⁻³	0.001
Centimeter	10,000	394	10	•	0.394	0.033	0.01
Inch	2.54x10 ⁴	1,000	25.4	2.54	•	0.083	0.0254
Foot	3.05x10 ⁵	1.2x10 ⁴	305	30.5	12	•	0.305
Meter	1.0x10 ⁶	3.94x10 ⁴	1,000	100	39.4	3.28	•

Liquid Pressure	LIQUID PRESSURE – EQUIVALENTS						
	Lb/In ² (psi)	Ft Water	Kg/Cm ²	Atmosphere	Bar	Inch Mercury	kPa (kilopascal)
Lb/In ² (psi)	•	2.31	0.070	0.068	0.069	2.04	6.895
Ft Water	0.433	•	0.030	0.029	0.030	0.882	2.99
Kg/Cm ²	14.2	32.8	•	0.968	0.981	29.0	98
Atmosphere	14.7	33.9	1.03	•	1.01	29.9	101
Bar	14.5	33.5	1.02	0.987	•	29.5	100
Inch Mercury	0.491	1.13	0.035	0.033	0.034	•	3.4
kPa (kilopascal)	0.145	0.335	0.01	0.009	0.01	0.296	•

EASY PUMP HEAD TABLE

Feet Head (Water)	PSI
10	4.3
20	8.6
30	13
40	17
50	22
60	26
70	30
80	34
90	38
100	42
110	46
120	50
130	54
140	58
150	61

Threaded Nozzles

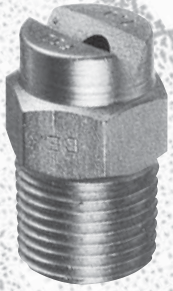

FV SERIES

Flat “V” spray nozzles



SPRAY CHARACTERISTICS:

FV-Series low flow rate spray nozzles produce a flat, fan-shaped spray pattern, with spray angles available from 0° to 110°. Spray density tapers off toward the outside of these sprays, to permit overlapping of spray patterns while maintaining uniform spray density.

CONSTRUCTION:

The models listed are machined from bar stock and are one piece construction. Standard materials are brass, 303 stainless steel and 316 stainless steel. Other materials may be available upon request. All parts are made with a female thread on the inlet to install BEX® strainers.

TYPICAL APPLICATIONS:

- Metal Washing
- Foam Control
- Wetting
- Vehicle Washing
- Fertilizer Spraying
- Food Processing

PIPE SIZE (NPT)	Length L (inches)	Dim. A (inches)	Internal Thread	Dim. B (with strainer assy) (inches)
1/8	13/16	7/16 HEX	1/4-32 UNEF	1.34
1/4	15/16	9/16 HEX	3/8-24 UNF	1.68

Mesh sizes available are 50, 100, and 200.



Available with strainer assembly.

FLAT SPRAY

Model	Equiv. Orifice Diameter (in)	CAPACITY AT VARIOUS PRESSURES (USGPM)											SPRAY ANGLE @ (degrees)			
													20	40	80	200
		5 psi	10 psi	20 psi	30 psi	40 psi	60 psi	80 psi	100 psi	200 psi	300 psi	500 psi	psi	psi	psi	psi
1/8FV11001	0.025	0.04	0.05	0.07	0.09	0.10	0.12	0.14	0.16	0.22	0.27	0.35	94	110	118	119
1/4FV11001	0.025	0.04	0.05	0.07	0.09	0.10	0.12	0.14	0.16	0.22	0.27	0.35	94	110	118	119
1/8FV110015	0.030	0.05	0.08	0.11	0.13	0.15	0.18	0.21	0.24	0.34	0.41	0.53	94	110	118	119
1/4FV110015	0.030	0.05	0.08	0.11	0.13	0.15	0.18	0.21	0.24	0.34	0.41	0.53	94	110	118	119
1/8FV11002	0.035	0.07	0.10	0.14	0.17	0.20	0.25	0.28	0.32	0.45	0.55	0.71	96	110	118	120
1/4FV11002	0.035	0.07	0.10	0.14	0.17	0.20	0.25	0.28	0.32	0.45	0.55	0.71	96	110	119	120
1/8FV11003	0.043	0.11	0.15	0.21	0.26	0.30	0.37	0.42	0.47	0.67	0.82	1.06	96	110	118	120
1/4FV11003	0.043	0.11	0.15	0.21	0.26	0.30	0.37	0.42	0.47	0.67	0.82	1.06	96	110	118	120
1/8FV11004	0.050	0.14	0.20	0.28	0.35	0.40	0.49	0.57	0.63	0.89	1.10	1.41	90	110	112	114
1/4FV11004	0.050	0.14	0.20	0.28	0.35	0.40	0.49	0.57	0.63	0.89	1.10	1.41	90	110	112	114
1/8FV11005	0.056	0.18	0.25	0.35	0.43	0.50	0.61	0.71	0.79	1.12	1.37	1.77	96	110	114	118
1/4FV11005	0.056	0.18	0.25	0.35	0.43	0.50	0.61	0.71	0.79	1.12	1.37	1.77	96	110	114	118
1/8FV11006	0.061	0.21	0.30	0.42	0.52	0.60	0.73	0.85	0.95	1.34	1.64	2.12	97	110	115	120
1/4FV11006	0.061	0.21	0.30	0.42	0.52	0.60	0.73	0.85	0.95	1.34	1.64	2.12	97	110	115	120
1/8FV11008	0.071	0.28	0.40	0.57	0.69	0.80	0.98	1.13	1.26	1.79	2.19	2.83	100	110	115	120
1/4FV11008	0.071	0.28	0.40	0.57	0.69	0.80	0.98	1.13	1.26	1.79	2.19	2.83	100	110	115	120
1/8FV9501	0.025	0.04	0.05	0.07	0.09	0.10	0.12	0.14	0.16	0.22	0.27	0.35	82	95	104	112
1/4FV9501	0.025	0.04	0.05	0.07	0.09	0.10	0.12	0.14	0.16	0.22	0.27	0.35	82	95	104	112
1/8FV95015	0.030	0.05	0.08	0.11	0.13	0.15	0.18	0.21	0.24	0.34	0.41	0.53	82	95	104	112
1/4FV95015	0.030	0.05	0.08	0.11	0.13	0.15	0.18	0.21	0.24	0.34	0.41	0.53	82	95	104	112
1/8FV9502	0.035	0.07	0.10	0.14	0.17	0.20	0.25	0.28	0.32	0.45	0.55	0.71	82	95	103	112
1/4FV9502	0.035	0.07	0.10	0.14	0.17	0.20	0.25	0.28	0.32	0.45	0.55	0.71	82	95	103	112
1/8FV9503	0.043	0.11	0.15	0.21	0.26	0.30	0.37	0.42	0.47	0.67	0.82	1.06	84	95	103	114
1/4FV9503	0.043	0.11	0.15	0.21	0.26	0.30	0.37	0.42	0.47	0.67	0.82	1.06	84	95	103	114
1/8FV9504	0.050	0.14	0.20	0.28	0.35	0.40	0.49	0.57	0.63	0.89	1.10	1.41	84	95	100	114

Model	Equiv. Orifice Diameter (in)	CAPACITY AT VARIOUS PRESSURES (USGPM)											SPRAY ANGLE @ (degrees)			
		5 psi	10 psi	20 psi	30 psi	40 psi	60 psi	80 psi	100 psi	200 psi	300 psi	500 psi	20 psi	40 psi	80 psi	200 psi
		1/4 FV9504	0.050	0.14	0.20	0.28	0.35	0.40	0.49	0.57	0.63	0.89	1.10	1.41	84	95
1/8 FV9505	0.056	0.18	0.25	0.35	0.43	0.50	0.61	0.71	0.79	1.12	1.37	1.77	86	95	101	115
1/4 FV9505	0.056	0.18	0.25	0.35	0.43	0.50	0.61	0.71	0.79	1.12	1.37	1.77	86	95	101	115
1/8 FV9506	0.061	0.21	0.30	0.42	0.52	0.60	0.73	0.85	0.95	1.34	1.64	2.12	86	95	101	115
1/4 FV9506	0.061	0.21	0.30	0.42	0.52	0.60	0.73	0.85	0.95	1.34	1.64	2.12	86	95	101	115
1/8 FV95065	0.063	0.23	0.32	0.46	0.56	0.65	0.80	0.92	1.03	1.45	1.78	2.30	86	95	101	115
1/4 FV95065	0.063	0.23	0.32	0.46	0.56	0.65	0.80	0.92	1.03	1.45	1.78	2.30	86	95	101	115
1/8 FV9508	0.071	0.28	0.40	0.57	0.69	0.80	0.98	1.13	1.26	1.79	2.19	2.83	86	95	100	115
1/4 FV9508	0.071	0.28	0.40	0.57	0.69	0.80	0.98	1.13	1.26	1.79	2.19	2.83	86	95	100	115
1/8 FV8001	0.025	0.04	0.05	0.07	0.09	0.10	0.12	0.14	0.16	0.22	0.27	0.35	70	80	82	90
1/4 FV8001	0.025	0.04	0.05	0.07	0.09	0.10	0.12	0.14	0.16	0.22	0.27	0.35	70	80	82	90
1/8 FV80015	0.030	0.05	0.08	0.11	0.13	0.15	0.18	0.21	0.24	0.34	0.41	0.53	70	80	82	90
1/4 FV80015	0.030	0.05	0.08	0.11	0.13	0.15	0.18	0.21	0.24	0.34	0.41	0.53	70	80	82	90
1/8 FV8002	0.035	0.07	0.10	0.14	0.17	0.20	0.25	0.28	0.32	0.45	0.55	0.71	71	80	82	92
1/4 FV8002	0.035	0.07	0.10	0.14	0.17	0.20	0.25	0.28	0.32	0.45	0.55	0.71	71	80	82	92
1/8 FV8003	0.043	0.11	0.15	0.21	0.26	0.30	0.37	0.42	0.47	0.67	0.82	1.06	72	80	82	92
1/4 FV8003	0.043	0.11	0.15	0.21	0.26	0.30	0.37	0.42	0.47	0.67	0.82	1.06	72	80	82	92
1/8 FV8005	0.056	0.18	0.25	0.35	0.43	0.50	0.61	0.71	0.79	1.12	1.37	1.77	74	80	83	95
1/4 FV8005	0.056	0.18	0.25	0.35	0.43	0.50	0.61	0.71	0.79	1.12	1.37	1.77	74	80	83	95
1/8 FV8006	0.061	0.21	0.30	0.42	0.52	0.60	0.73	0.85	0.95	1.34	1.64	2.12	74	80	83	95
1/4 FV8006	0.061	0.21	0.30	0.42	0.52	0.60	0.73	0.85	0.95	1.34	1.64	2.12	74	80	83	95
1/8 FV8008	0.071	0.28	0.40	0.57	0.69	0.80	0.98	1.13	1.26	1.79	2.19	2.83	75	80	83	96
1/4 FV8008	0.071	0.28	0.40	0.57	0.69	0.80	0.98	1.13	1.26	1.79	2.19	2.83	75	80	83	96
1/8 FV6501	0.025	0.04	0.05	0.07	0.09	0.10	0.12	0.14	0.16	0.22	0.27	0.35	48	65	73	78
1/4 FV6501	0.025	0.04	0.05	0.07	0.09	0.10	0.12	0.14	0.16	0.22	0.27	0.35	48	65	73	78
1/8 FV65015	0.030	0.05	0.08	0.11	0.13	0.15	0.18	0.21	0.24	0.34	0.41	0.53	48	65	73	78
1/4 FV65015	0.030	0.05	0.08	0.11	0.13	0.15	0.18	0.21	0.24	0.34	0.41	0.53	48	65	73	78
1/8 FV6502	0.035	0.07	0.10	0.14	0.17	0.20	0.25	0.28	0.32	0.45	0.55	0.71	48	65	73	79
1/4 FV6502	0.035	0.07	0.10	0.14	0.17	0.20	0.25	0.28	0.32	0.45	0.55	0.71	48	65	73	79
1/8 FV65025	0.039	0.09	0.13	0.18	0.22	0.25	0.31	0.35	0.40	0.56	0.68	0.88	48	65	73	79
1/4 FV65025	0.039	0.09	0.13	0.18	0.22	0.25	0.31	0.35	0.40	0.56	0.68	0.88	48	65	73	79
1/8 FV6503	0.043	0.11	0.15	0.21	0.26	0.30	0.37	0.42	0.47	0.67	0.82	1.06	50	65	70	78
1/4 FV6503	0.043	0.11	0.15	0.21	0.26	0.30	0.37	0.42	0.47	0.67	0.82	1.06	50	65	70	78
1/8 FV6504	0.050	0.14	0.20	0.28	0.35	0.40	0.49	0.57	0.63	0.89	1.10	1.41	50	65	78	80
1/4 FV6504	0.050	0.14	0.20	0.28	0.35	0.40	0.49	0.57	0.63	0.89	1.10	1.41	50	65	78	80
1/8 FV6505	0.056	0.18	0.25	0.35	0.43	0.50	0.61	0.71	0.79	1.12	1.37	1.77	53	65	72	81
1/4 FV6505	0.056	0.18	0.25	0.35	0.43	0.50	0.61	0.71	0.79	1.12	1.37	1.77	53	65	72	81
1/8 FV6506	0.061	0.21	0.30	0.42	0.52	0.60	0.73	0.85	0.95	1.34	1.64	2.12	54	65	72	81
1/4 FV6506	0.061	0.21	0.30	0.42	0.52	0.60	0.73	0.85	0.95	1.34	1.64	2.12	54	65	72	81
1/8 FV6508	0.071	0.28	0.40	0.57	0.69	0.80	0.98	1.13	1.26	1.79	2.19	2.83	55	65	71	82
1/4 FV6508	0.071	0.28	0.40	0.57	0.69	0.80	0.98	1.13	1.26	1.79	2.19	2.83	55	65	71	82
1/8 FV5001	0.025	0.04	0.05	0.07	0.09	0.10	0.12	0.14	0.16	0.22	0.27	0.35	40	50	53	63
1/4 FV5001	0.025	0.04	0.05	0.07	0.09	0.10	0.12	0.14	0.16	0.22	0.27	0.35	40	50	53	63
1/8 FV5002	0.035	0.07	0.10	0.14	0.17	0.20	0.25	0.28	0.32	0.45	0.55	0.71	40	50	53	61
1/4 FV5002	0.035	0.07	0.10	0.14	0.17	0.20	0.25	0.28	0.32	0.45	0.55	0.71	40	50	53	61
1/8 FV5003	0.043	0.11	0.15	0.21	0.26	0.30	0.37	0.42	0.47	0.67	0.82	1.06	42	50	54	62
1/4 FV5003	0.043	0.11	0.15	0.21	0.26	0.30	0.37	0.42	0.47	0.67	0.82	1.06	42	50	54	62
1/8 FV5004	0.050	0.14	0.20	0.28	0.35	0.40	0.49	0.57	0.63	0.89	1.10	1.41	43	50	54	62
1/4 FV5004	0.050	0.14	0.20	0.28	0.35	0.40	0.49	0.57	0.63	0.89	1.10	1.41	43	50	54	62
1/8 FV5005	0.056	0.18	0.25	0.35	0.43	0.50	0.61	0.71	0.79	1.12	1.37	1.77	44	50	56	60
1/4 FV5005	0.056	0.18	0.25	0.35	0.43	0.50	0.61	0.71	0.79	1.12	1.37	1.77	44	50	56	60
1/8 FV5006	0.061	0.21	0.30	0.42	0.52	0.60	0.73	0.85	0.95	1.34	1.64	2.12	45	50	56	60
1/4 FV5006	0.061	0.21	0.30	0.42	0.52	0.60	0.73	0.85	0.95	1.34	1.64	2.12	45	50	56	60
1/8 FV5008	0.071	0.28	0.40	0.57	0.69	0.80	0.98	1.13	1.26	1.79	2.19	2.83	45	50	56	60
1/4 FV5008	0.071	0.28	0.40	0.57	0.69	0.80	0.98	1.13	1.26	1.79	2.19	2.83	45	50	56	60

FLAT SPRAY

FV SERIES

Flat "V" spray nozzles continued

FLAT SPRAY

Model	Equiv. Orifice Diameter (in)	CAPACITY AT VARIOUS PRESSURES (USGPM)											SPRAY ANGLE @ (degrees)			
		5 psi	10 psi	20 psi	30 psi	40 psi	60 psi	80 psi	100 psi	200 psi	300 psi	500 psi	20 psi	40 psi	80 psi	200 psi
1/8FV4001	0.025	0.04	0.05	0.07	0.09	0.10	0.12	0.14	0.16	0.22	0.27	0.35	26	40	51	58
1/4FV4001	0.025	0.04	0.05	0.07	0.09	0.10	0.12	0.14	0.16	0.22	0.27	0.35	26	40	51	58
1/8FV40015	0.030	0.05	0.08	0.11	0.13	0.15	0.18	0.21	0.24	0.34	0.41	0.53	27	40	50	58
1/4FV40015	0.030	0.05	0.08	0.11	0.13	0.15	0.18	0.21	0.24	0.34	0.41	0.53	27	40	50	58
1/8FV4002	0.035	0.07	0.10	0.14	0.17	0.20	0.25	0.28	0.32	0.45	0.55	0.71	27	40	49	56
1/4FV4002	0.035	0.07	0.10	0.14	0.17	0.20	0.25	0.28	0.32	0.45	0.55	0.71	27	40	49	56
1/8FV4003	0.043	0.11	0.15	0.21	0.26	0.30	0.37	0.42	0.47	0.67	0.82	1.06	28	40	49	50
1/4FV4003	0.043	0.11	0.15	0.21	0.26	0.30	0.37	0.42	0.47	0.67	0.82	1.06	28	40	49	50
1/8FV4004	0.050	0.14	0.20	0.28	0.35	0.40	0.49	0.57	0.63	0.89	1.10	1.41	28	40	50	50
1/4FV4004	0.050	0.14	0.20	0.28	0.35	0.40	0.49	0.57	0.63	0.89	1.10	1.41	28	40	50	50
1/8FV4005	0.056	0.18	0.25	0.35	0.43	0.50	0.61	0.71	0.79	1.12	1.37	1.77	26	40	46	53
1/4FV4005	0.056	0.18	0.25	0.35	0.43	0.50	0.61	0.71	0.79	1.12	1.37	1.77	26	40	46	53
1/8FV4006	0.061	0.21	0.30	0.42	0.52	0.60	0.73	0.85	0.95	1.34	1.64	2.12	37	40	44	52
1/4FV4006	0.061	0.21	0.30	0.42	0.52	0.60	0.73	0.85	0.95	1.34	1.64	2.12	37	40	44	52
1/8FV4008	0.071	0.28	0.40	0.57	0.69	0.80	0.98	1.13	1.26	1.79	2.19	2.83	35	40	43	53
1/4FV4008	0.071	0.28	0.40	0.57	0.69	0.80	0.98	1.13	1.26	1.79	2.19	2.83	35	40	43	53
1/8FV2501	0.025	0.04	0.05	0.07	0.09	0.10	0.12	0.14	0.16	0.22	0.27	0.35	14	25	34	41
1/4FV2501	0.025	0.04	0.05	0.07	0.09	0.10	0.12	0.14	0.16	0.22	0.27	0.35	14	25	34	41
1/8FV2502	0.034	0.07	0.10	0.14	0.17	0.20	0.25	0.28	0.32	0.45	0.55	0.71	14	25	33	40
1/4FV2502	0.034	0.07	0.10	0.14	0.17	0.20	0.25	0.28	0.32	0.45	0.55	0.71	14	25	33	40
1/8FV2503	0.043	0.11	0.15	0.21	0.26	0.30	0.37	0.42	0.47	0.67	0.82	1.06	18	25	30	37
1/4FV2503	0.043	0.11	0.15	0.21	0.26	0.30	0.37	0.42	0.47	0.67	0.82	1.06	18	25	30	37
1/8FV2505	0.056	0.18	0.25	0.35	0.43	0.50	0.61	0.71	0.79	1.12	1.37	1.77	20	25	31	37
1/4FV2505	0.056	0.18	0.25	0.35	0.43	0.50	0.61	0.71	0.79	1.12	1.37	1.77	20	25	31	37
1/8FV2506	0.061	0.21	0.30	0.42	0.52	0.60	0.73	0.85	0.95	1.34	1.64	2.12	17	25	31	38
1/4FV2506	0.061	0.21	0.30	0.42	0.52	0.60	0.73	0.85	0.95	1.34	1.64	2.12	17	25	31	38
1/8FV2508	0.071	0.28	0.40	0.57	0.69	0.80	0.98	1.13	1.26	1.79	2.19	2.83	16	25	31	38
1/4FV2508	0.071	0.28	0.40	0.57	0.69	0.80	0.98	1.13	1.26	1.79	2.19	2.83	16	25	31	38
1/8FV1501	0.025	0.04	0.05	0.07	0.09	0.10	0.12	0.14	0.16	0.22	0.27	0.35	--	15	22	25
1/4FV1501	0.025	0.04	0.05	0.07	0.09	0.10	0.12	0.14	0.16	0.22	0.27	0.35	--	15	22	25
1/8FV1502	0.035	0.07	0.10	0.14	0.17	0.20	0.25	0.28	0.32	0.45	0.55	0.71	6	15	21	24
1/4FV1502	0.035	0.07	0.10	0.14	0.17	0.20	0.25	0.28	0.32	0.45	0.55	0.71	6	15	21	24
1/8FV1503	0.043	0.11	0.15	0.21	0.26	0.30	0.37	0.42	0.47	0.67	0.82	1.06	7	15	19	22
1/4FV1503	0.043	0.11	0.15	0.21	0.26	0.30	0.37	0.42	0.47	0.67	0.82	1.06	7	15	19	22
1/8FV1504	0.050	0.14	0.20	0.28	0.35	0.40	0.49	0.57	0.63	0.89	1.10	1.41	8	15	19	22
1/4FV1504	0.050	0.14	0.20	0.28	0.35	0.40	0.49	0.57	0.63	0.89	1.10	1.41	8	15	19	22
1/8FV1505	0.056	0.18	0.25	0.35	0.43	0.50	0.61	0.71	0.79	1.12	1.37	1.77	10	15	20	25
1/4FV1505	0.056	0.18	0.25	0.35	0.43	0.50	0.61	0.71	0.79	1.12	1.37	1.77	10	15	20	25
1/8FV1506	0.061	0.21	0.30	0.42	0.52	0.60	0.73	0.85	0.95	1.34	1.64	2.12	11	15	24	28
1/4FV1506	0.061	0.21	0.30	0.42	0.52	0.60	0.73	0.85	0.95	1.34	1.64	2.12	11	15	24	28
1/8FV1508	0.071	0.28	0.40	0.57	0.69	0.80	0.98	1.13	1.26	1.79	2.19	2.83	11	15	21	26
1/4FV1508	0.071	0.28	0.40	0.57	0.69	0.80	0.98	1.13	1.26	1.79	2.19	2.83	11	15	21	26
1/8FV0505	0.053	0.18	0.25	0.35	0.43	0.50	0.61	0.71	0.79	0.22	1.37	0.35	4	5	9	
1/4FV0505	0.053	0.18	0.25	0.35	0.43	0.50	0.61	0.71	0.79	0.22	1.37	0.35	4	5	9	
1/8FV0506	0.058	0.21	0.30	0.42	0.52	0.60	0.73	0.85	0.95	0.45	1.64	0.71	5	5	8	
1/4FV0506	0.058	0.21	0.30	0.42	0.52	0.60	0.73	0.85	0.95	0.45	1.64	0.71	5	5	8	
1/8FV0508	0.067	0.28	0.40	0.57	0.69	0.80	0.98	1.13	1.26	0.67	2.19	1.06	4	5	7	
1/4FV0508	0.067	0.28	0.40	0.57	0.69	0.80	0.98	1.13	1.26	0.67	2.19	1.06	4	5	7	
1/8FV0003	0.041	0.40	0.15	0.21	0.26	0.30	0.37	0.42	0.47	0.67	0.82	1.06	0 Degree Spray Angle			
1/4FV0003	0.041	0.11	0.15	0.21	0.26	0.40	0.37	0.42	0.47	0.67	0.82	1.06				
1/8FV0004	0.047	0.14	0.20	0.28	0.35	0.40	0.49	0.57	0.63	0.89	1.10	1.41				
1/4FV0004	0.047	0.14	0.20	0.28	0.35	0.40	0.49	0.57	0.63	0.89	1.10	1.41				
1/8FV0005	0.053	0.14	0.20	0.28	0.35	0.50	0.49	0.57	0.63	0.89	1.10	1.41				
1/4FV0005	0.053	0.14	0.20	0.28	0.35	0.40	0.49	0.57	0.63	0.89	1.10	1.41				
1/8FV0006	0.058	0.21	0.30	0.42	0.52	0.60	0.73	0.85	0.95	1.34	1.64	2.12				
1/4FV0006	0.058	0.21	0.30	0.42	0.52	0.60	0.73	0.85	0.95	1.34	1.64	2.12				
1/8FV0008	0.067	0.28	0.40	0.57	0.69	0.80	0.98	1.13	1.26	1.79	2.19	2.83				
1/4FV0008	0.067	0.28	0.40	0.57	0.69	0.80	0.98	1.13	1.26	1.79	2.19	2.83				

Flat "V" spray nozzles

F SERIES

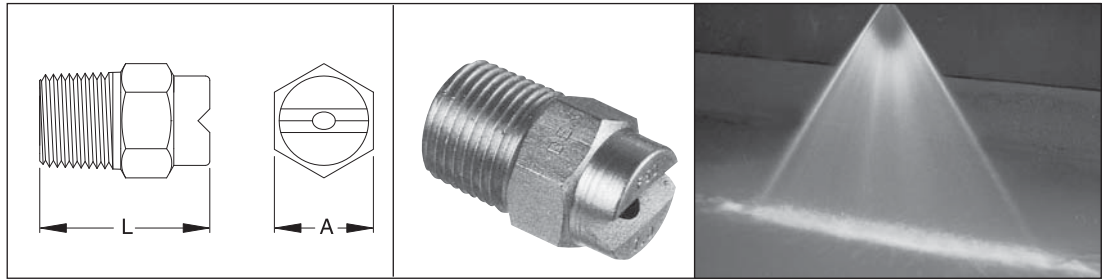

SPRAY CHARACTERISTICS:

F-Series spray nozzles produce a flat, fan-shaped spray pattern, with spray angles available from 5° to 110° measured at 40 psi. Spray angles generally increase with pressure, as shown in the capacity table.

Spray density tapers off toward the outside of these sprays, to permit overlapping of spray patterns while maintaining uniform spray density.

See page 22 for 0° solid stream spray nozzles.

CONSTRUCTION:

The models listed are machined from bar stock and are one piece construction. Standard materials are brass, mild steel, 303 stainless steel and 316 stainless steel. Some models are also stocked in Carpenter 20°, PVC, CPVC and polypropylene. All models are available in either NPT or BSPT threads.

For molded plastic models, please see page 23.

TYPICAL APPLICATIONS:

Suitable for a variety of washing and spraying applications.

- Parts Cleaning
- Metal Washing
- Foam Control
- Gravel Washing
- Vehicle Washing
- Fertilizer Spraying
- Dishwashers

ACCESSORIES:

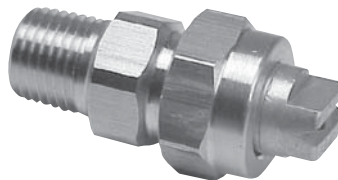

F-Series flat "V" spray nozzles are also offered in the FT-Series 3-piece setup.

DIMENSIONS

PIPE SIZE (NPT)	Length L (inches)	Dim. A (inches)
1/8	13/16	7/16 HEX
1/4	15/16	9/16 HEX
3/8	1 3/16	1 1/16 HEX
1/2	1 5/16	7/8 HEX
3/4	1 11/16	1 1/16 HEX
1	2 1/2	1 3/8 HEX
1 1/4	3 5/8	1 3/4 HEX
1 1/2	4 1/4	2 Dia.
2	5	2 3/8 Dia.

FLAT SPRAY

SPRAY ANGLE @ 40psi	MODEL NUMBER	PIPE SIZE NPT	EQUIV. ORIFICE DIAMETER (inches)	CAPACITY (GPM) AT VARIOUS PRESSURES (psi)													SPRAY ANGLE @		
				5 psi	7 psi	10 psi	15 psi	20 psi	30 psi	40 psi	50 psi	60 psi	80 psi	100 psi	150 psi	300 psi	20 psi	40 psi	80 psi
110°	1/8F11010	1/8	0.075	0.35	0.42	0.5	0.61	0.71	0.87	1.00	1.12	1.22	1.41	1.58	1.94	2.7	102°	110°	115°
	1/4F11010	1/4	0.075	0.35	0.42	0.5	0.61	0.71	0.87	1.00	1.12	1.22	1.41	1.58	1.94	2.7	102°	110°	115°
	1/8F11015	1/8	0.091	0.53	0.63	0.75	0.92	1.06	1.30	1.50	1.68	1.84	2.12	2.4	2.9	4.1	102°	110°	115°
	1/4F11015	1/4	0.091	0.53	0.63	0.75	0.92	1.06	1.30	1.50	1.68	1.84	2.12	2.4	2.9	4.1	102°	110°	115°
	1/8F11020	1/8	0.105	0.71	0.84	1.00	1.22	1.41	1.73	2.00	2.2	2.4	2.8	3.2	3.9	5.5	103°	110°	112°
	1/4F11020	1/4	0.105	0.71	0.84	1.00	1.22	1.41	1.73	2.00	2.2	2.4	2.8	3.2	3.9	5.5	103°	110°	112°
	1/4F11030	1/4	0.129	1.06	1.25	1.50	1.84	2.1	2.6	3.0	3.4	3.7	4.2	4.7	5.8	8.2	103°	110°	112°
	1/4F11040	1/4	0.149	1.41	1.67	2.00	2.4	2.8	3.5	4.0	4.5	4.9	5.7	6.3	7.7	11.0	103°	110°	112°
	1/4F11050	1/4	0.167	1.77	2.09	2.5	3.1	3.5	4.3	5.0	5.6	6.1	7.1	7.9	9.7	13.7	107°	110°	116°

SPRAY ANGLE @ 40psi	MODEL NUMBER	PIPE SIZE NPT	EQUIV. ORIFICE DIAMETER (inches)	CAPACITY (GPM) AT VARIOUS PRESSURES (psi)													SPRAY ANGLE @		
				5 psi	7 psi	10 psi	15 psi	20 psi	30 psi	40 psi	50 psi	60 psi	80 psi	100 psi	150 psi	300 psi	20 psi	40 psi	80 psi
95°	1/8F9510	1/8	0.075	0.35	0.42	0.50	0.61	0.71	0.87	1.00	1.12	1.22	1.41	1.58	1.94	2.7	88°	95°	99°
	1/4F9510	1/4	0.075	0.35	0.42	0.50	0.61	0.71	0.87	1.00	1.12	1.22	1.41	1.58	1.94	2.7	88°	95°	99°
	1/8F9515	1/8	0.091	0.53	0.63	0.75	0.92	1.06	1.30	1.5	1.68	1.84	2.1	2.4	2.9	4.1	90°	95°	100°
	1/4F9515	1/4	0.091	0.53	0.63	0.75	0.92	1.06	1.30	1.5	1.68	1.84	2.1	2.4	2.9	4.1	90°	95°	100°
	1/8F9520	1/8	0.105	0.71	0.84	1.00	1.22	1.41	1.73	2.0	2.2	2.4	2.8	3.2	3.9	5.5	89°	95°	99°
	1/4F9520	1/4	0.105	0.71	0.84	1.00	1.22	1.41	1.73	2.0	2.2	2.4	2.8	3.2	3.9	5.5	89°	95°	99°
	1/8F9530	1/8	0.129	1.06	1.25	1.50	1.84	2.1	2.6	3.0	3.4	3.7	4.2	4.7	5.8	8.2	90°	95°	101°
	1/4F9530	1/4	0.129	1.06	1.25	1.50	1.84	2.1	2.6	3.0	3.4	3.7	4.2	4.7	5.8	8.2	90°	95°	101°
	3/8F9530	3/8	0.129	1.06	1.25	1.50	1.84	2.1	2.6	3.0	3.4	3.7	4.2	4.7	5.8	8.2	90°	95°	101°
	1/4F9540	1/4	0.149	1.41	1.67	2.0	2.4	2.8	3.5	4.0	4.5	4.9	5.7	6.3	7.7	11.0	90°	95°	100°
	3/8F9540	3/8	0.149	1.41	1.67	2.0	2.4	2.8	3.5	4.0	4.5	4.9	5.7	6.3	7.7	11.0	90°	95°	100°
	1/4F9550	1/4	0.167	1.77	2.1	2.5	3.1	3.5	4.3	5.0	5.6	6.1	7.1	7.9	9.7	13.7	91°	95°	101°
	3/8F9550	3/8	0.167	1.77	2.1	2.5	3.1	3.5	4.3	5.0	5.6	6.1	7.1	7.9	9.7	13.7	91°	95°	101°
	1/4F9560	1/4	0.182	2.1	2.5	3.0	3.7	4.2	5.2	6.0	6.7	7.3	8.5	9.5	11.6	16.4	92°	95°	102°
	3/8F9560	3/8	0.182	2.1	2.5	3.0	3.7	4.2	5.2	6.0	6.7	7.3	8.5	9.5	11.6	16.4	92°	95°	102°
	1/2F9560	1/2	0.182	2.1	2.5	3.0	3.7	4.2	5.2	6.0	6.7	7.3	8.5	9.5	11.6	16.4	91°	95°	102°
	1/4F9570	1/4	0.197	2.5	2.9	3.5	4.3	4.9	6.1	7.0	7.8	8.6	9.9	11.1	13.6	19.2	92°	95°	103°
	3/8F9570	3/8	0.197	2.5	2.9	3.5	4.3	4.9	6.1	7.0	7.8	8.6	9.9	11.1	13.6	19.2	90°	95°	101°
	1/2F9570	1/2	0.197	2.5	2.9	3.5	4.3	4.9	6.1	7.0	7.8	8.6	9.9	11.1	13.6	19.2	90°	95°	101°
	1/2F95100	1/2	0.236	3.5	4.2	5.0	6.1	7.1	8.7	10.0	11.2	12.2	14.1	15.8	19.4	27	92°	95°	103°
1/2F95150	1/2	0.289	5.3	6.3	7.5	9.2	10.6	13.0	15.0	16.8	18.4	21	24	29	41	92°	95°	102°	
80°	1/8F8010	1/8	0.075	0.35	0.42	0.50	0.61	0.71	0.87	1.00	1.12	1.22	1.41	1.58	1.94	2.7	75°	80°	83°
	1/4F8010	1/4	0.075	0.35	0.42	0.50	0.61	0.71	0.87	1.00	1.12	1.22	1.41	1.58	1.94	2.7	75°	80°	83°
	3/8F8010	3/8	0.075	0.35	0.42	0.50	0.61	0.71	0.87	1.00	1.12	1.22	1.41	1.58	1.94	2.7	75°	80°	83°
	1/8F8015	1/8	0.091	0.53	0.63	0.75	0.92	1.06	1.30	1.5	1.68	1.84	2.1	2.4	2.9	4.1	74°	80°	86°
	1/4F8015	1/4	0.091	0.53	0.63	0.75	0.92	1.06	1.30	1.5	1.68	1.84	2.1	2.4	2.9	4.1	74°	80°	86°
	3/8F8015	3/8	0.091	0.53	0.63	0.75	0.92	1.06	1.30	1.5	1.68	1.84	2.1	2.4	2.9	4.1	75°	80°	86°
	1/8F8020	1/8	0.105	0.71	0.84	1.00	1.22	1.41	1.73	2.0	2.2	2.4	2.8	3.2	3.9	5.5	74°	80°	85°
	1/4F8020	1/4	0.105	0.71	0.84	1.00	1.22	1.41	1.73	2.0	2.2	2.4	2.8	3.2	3.9	5.5	74°	80°	85°
	3/8F8020	3/8	0.105	0.71	0.84	1.00	1.22	1.41	1.73	2.0	2.2	2.4	2.8	3.2	3.9	5.5	74°	80°	85°
	1/8F8030	1/8	0.129	1.06	1.25	1.50	1.84	2.1	2.6	3.0	3.4	3.7	4.2	4.7	5.8	8.2	75°	80°	86°
	1/4F8030	1/4	0.129	1.06	1.25	1.50	1.84	2.1	2.6	3.0	3.4	3.7	4.2	4.7	5.8	8.2	75°	80°	86°
	3/8F8030	3/8	0.129	1.06	1.25	1.50	1.84	2.1	2.6	3.0	3.4	3.7	4.2	4.7	5.8	8.2	75°	80°	86°
	1/8F8040	1/8	0.149	1.41	1.67	2.0	2.4	2.8	3.5	4.0	4.5	4.9	5.7	6.3	7.7	11.0	76°	80°	85°
	1/4F8040	1/4	0.149	1.41	1.67	2.0	2.4	2.8	3.5	4.0	4.5	4.9	5.7	6.3	7.7	11.0	76°	80°	85°
	3/8F8040	3/8	0.149	1.41	1.67	2.0	2.4	2.8	3.5	4.0	4.5	4.9	5.7	6.3	7.7	11.0	76°	80°	85°
	1/4F8050	1/4	0.167	1.77	2.1	2.5	3.1	3.5	4.3	5.0	5.6	6.1	7.1	7.9	9.7	13.7	77°	80°	84°
	3/8F8050	3/8	0.167	1.77	2.1	2.5	3.1	3.5	4.3	5.0	5.6	6.1	7.1	7.9	9.7	13.7	77°	80°	84°
	1/4F8060	1/4	0.182	2.1	2.5	3.0	3.7	4.2	5.2	6.0	6.7	7.3	8.5	9.5	11.6	16.4	77°	80°	84°
	3/8F8060	3/8	0.182	2.1	2.5	3.0	3.7	4.2	5.2	6.0	6.7	7.3	8.5	9.5	11.6	16.4	77°	80°	84°
	1/2F8060	1/2	0.182	2.1	2.5	3.0	3.7	4.2	5.2	6.0	6.7	7.3	8.5	9.5	11.6	16.4	78°	80°	84°
1/4F8070	1/4	0.197	2.5	2.9	3.5	4.3	4.9	6.1	7.0	7.8	8.6	9.9	11.1	13.6	19.2	78°	80°	87°	
3/8F8070	3/8	0.197	2.5	2.9	3.5	4.3	4.9	6.1	7.0	7.8	8.6	9.9	11.1	13.6	19.2	78°	80°	87°	
1/2F8070	1/2	0.197	2.5	2.9	3.5	4.3	4.9	6.1	7.0	7.8	8.6	9.9	11.1	13.6	19.2	78°	80°	87°	
1/4F8080	1/4	0.211	2.8	3.3	4.0	4.9	5.7	6.9	8.0	8.9	9.8	11.3	12.6	15.5	21.9	78°	80°	88°	
3/8F8080	3/8	0.211	2.8	3.3	4.0	4.9	5.7	6.9	8.0	8.9	9.8	11.3	12.6	15.5	21.9	78°	80°	88°	
1/2F8080	1/2	0.211	2.8	3.3	4.0	4.9	5.7	6.9	8.0	8.9	9.8	11.3	12.6	15.5	21.9	78°	80°	88°	

CONTINUED on next page...

FLAT SPRAY

SPRAY ANGLE @ 40psi	MODEL NUMBER	PIPE SIZE NPT	EQUIV. ORIFICE DIAMETER (inches)	CAPACITY (GPM) AT VARIOUS PRESSURES (psi)													SPRAY ANGLE @		
				5 psi	7 psi	10 psi	15 psi	20 psi	30 psi	40 psi	50 psi	60 psi	80 psi	100 psi	150 psi	300 psi	20 psi	40 psi	80 psi
80°	3/8F80100	3/8	0.236	3.5	4.2	5.0	6.1	7.1	8.7	10.0	11.2	12.2	14.1	15.8	19.4	27	75°	80°	83°
	1/2F80100	1/2	0.236	3.5	4.2	5.0	6.1	7.1	8.7	10.0	11.2	12.2	14.1	15.8	19.4	27	75°	80°	83°
	3/8F80150	3/8	0.289	5.3	6.3	7.5	9.2	10.6	13.0	15.0	16.8	18.4	21	24	29	41	73°	80°	84°
	1/2F80150	1/2	0.289	5.3	6.3	7.5	9.2	10.6	13.0	15.0	16.8	18.4	21	24	29	41	73°	80°	84°
	1/2F80200	1/2	0.333	7.1	8.4	10.0	12.2	14.1	17.3	20	22	24	28	32	39	55	74°	80°	82°
	3/4F80200	3/4	0.333	7.1	8.4	10.0	12.2	14.1	17.3	20	22	24	28	32	39	55	74°	80°	82°
	3/4F80400	3/4	0.471	14.1	16.7	20	24	28	35	40	45	49	57	63	77	110	74°	80°	82°
65°	1/8F6510	1/8	0.075	0.35	0.42	0.50	0.61	0.71	0.87	1.00	1.12	1.22	1.41	1.58	1.94	2.7	57°	65°	73°
	1/4F6510	1/4	0.075	0.35	0.42	0.50	0.61	0.71	0.87	1.00	1.12	1.22	1.41	1.58	1.94	2.7	57°	65°	73°
	3/8F6510	3/8	0.075	0.35	0.42	0.50	0.61	0.71	0.87	1.00	1.12	1.22	1.41	1.58	1.94	2.7	57°	65°	73°
	1/8F6512	1/8	0.082	0.42	0.50	0.60	0.73	0.85	1.04	1.20	1.34	1.47	1.70	1.90	2.3	3.3	59°	65°	71°
	1/4F6512	1/4	0.082	0.42	0.50	0.60	0.73	0.85	1.04	1.20	1.34	1.47	1.70	1.90	2.3	3.3	60°	65°	72°
	1/8F6515	1/8	0.091	0.53	0.63	0.75	0.92	1.06	1.30	1.50	1.68	1.84	2.1	2.4	2.9	4.1	59°	65°	72°
	1/4F6515	1/4	0.091	0.53	0.63	0.75	0.92	1.06	1.30	1.50	1.68	1.84	2.1	2.4	2.9	4.1	59°	65°	72°
	3/8F6515	3/8	0.091	0.53	0.63	0.75	0.92	1.06	1.30	1.50	1.68	1.84	2.1	2.4	2.9	4.1	60°	65°	72°
	1/8F6520	1/8	0.105	0.71	0.84	1.00	1.22	1.41	1.73	2.0	2.2	2.4	2.8	3.2	3.9	5.5	61°	65°	72°
	1/4F6520	1/4	0.105	0.71	0.84	1.00	1.22	1.41	1.73	2.0	2.2	2.4	2.8	3.2	3.9	5.5	61°	65°	72°
	3/8F6520	3/8	0.105	0.71	0.84	1.00	1.22	1.41	1.73	2.0	2.2	2.4	2.8	3.2	3.9	5.5	61°	65°	72°
	1/8F6530	1/8	0.129	1.06	1.25	1.50	1.84	2.1	2.6	3.0	3.4	3.7	4.2	4.7	5.8	8.2	62°	65°	72°
	1/4F6530	1/4	0.129	1.06	1.25	1.50	1.84	2.1	2.6	3.0	3.4	3.7	4.2	4.7	5.8	8.2	62°	65°	72°
	3/8F6530	3/8	0.129	1.06	1.25	1.50	1.84	2.1	2.6	3.0	3.4	3.7	4.2	4.7	5.8	8.2	62°	65°	72°
	1/8F6540	1/8	0.149	1.41	1.67	2.0	2.4	2.8	3.5	4.0	4.5	4.9	5.7	6.3	7.7	11.0	63°	65°	72°
	1/4F6540	1/4	0.149	1.41	1.67	2.0	2.4	2.8	3.5	4.0	4.5	4.9	5.7	6.3	7.7	11.0	63°	65°	72°
	3/8F6540	3/8	0.149	1.41	1.67	2.0	2.4	2.8	3.5	4.0	4.5	4.9	5.7	6.3	7.7	11.0	64°	65°	74°
	1/4F6550	1/4	0.167	1.77	2.1	2.5	3.1	3.5	4.3	5.0	5.6	6.1	7.1	7.9	9.7	13.7	63°	65°	73°
	3/8F6550	3/8	0.167	1.77	2.1	2.5	3.1	3.5	4.3	5.0	5.6	6.1	7.1	7.9	9.7	13.7	63°	65°	73°
	1/2F6550	1/2	0.167	1.77	2.1	2.5	3.1	3.5	4.3	5.0	5.6	6.1	7.1	7.9	9.7	13.7	63°	65°	74°
	1/4F6560	1/4	0.182	2.1	2.5	3.0	3.7	4.2	5.2	6.0	6.7	7.3	8.5	9.5	11.6	16.4	63°	65°	73°
	3/8F6560	3/8	0.182	2.1	2.5	3.0	3.7	4.2	5.2	6.0	6.7	7.3	8.5	9.5	11.6	16.4	63°	65°	73°
	1/2F6560	1/2	0.182	2.1	2.5	3.0	3.7	4.2	5.2	6.0	6.7	7.3	8.5	9.5	11.6	16.4	63°	65°	73°
	1/4F6570	1/4	0.197	2.5	2.9	3.5	4.3	4.9	6.1	7.0	7.8	8.6	9.9	11.1	13.6	19.2	63°	65°	74°
	3/8F6570	3/8	0.197	2.5	2.9	3.5	4.3	4.9	6.1	7.0	7.8	8.6	9.9	11.1	13.6	19.2	63°	65°	74°
	1/2F6570	1/2	0.197	2.5	2.9	3.5	4.3	4.9	6.1	7.0	7.8	8.6	9.9	11.1	13.6	19.2	63°	65°	75°
	3/8F65100	3/8	0.236	3.5	4.2	5.0	6.1	7.1	8.7	10	11	12	14	16	19	27	59°	65°	69°
	1/2F65100	1/2	0.236	3.5	4.2	5.0	6.1	7.1	8.7	10	11	12	14	16	19	27	59°	65°	70°
1/2F65150	1/2	0.289	5.3	6.3	7.5	9.2	10.6	13.0	15	17	18	21	24	29	41	59°	65°	68°	
1/2F65200	1/2	0.333	7.1	8.4	10.0	12.2	14.1	17.3	20	22	24	28	32	39	55	60°	65°	67°	
3/4F65200	3/4	0.333	7.1	8.4	10.0	12.2	14.1	17.3	20	22	24	28	32	39	55	60°	65°	67°	
3/4F65300	3/4	0.408	10.6	12.5	15.0	18.4	21	26	30	34	37	42	47	58	82	60°	65°	68°	
3/4F65400	3/4	0.471	14.1	16.7	20	24	28	35	40	45	49	57	63	77	110	60°	65°	68°	
50°	1/8F5010	1/8	0.075	0.35	0.42	0.50	0.61	0.71	0.87	1.00	1.12	1.22	1.41	1.58	1.94	2.7	43°	50°	55°
	1/4F5010	1/4	0.075	0.35	0.42	0.50	0.61	0.71	0.87	1.00	1.12	1.22	1.41	1.58	1.94	2.7	43°	50°	55°
	3/8F5010	3/8	0.075	0.35	0.42	0.50	0.61	0.71	0.87	1.00	1.12	1.22	1.41	1.58	1.94	2.7	43°	50°	55°
	1/4F5015	1/4	0.091	0.53	0.63	0.75	0.92	1.06	1.30	1.50	1.68	1.84	2.1	2.4	2.9	4.1	43°	50°	55°
	3/8F5015	3/8	0.091	0.53	0.63	0.75	0.92	1.06	1.30	1.50	1.68	1.84	2.1	2.4	2.9	4.1	43°	50°	55°

CONTINUED on next page...

FLAT SPRAY

F SERIES

Flat "V" spray nozzles continued

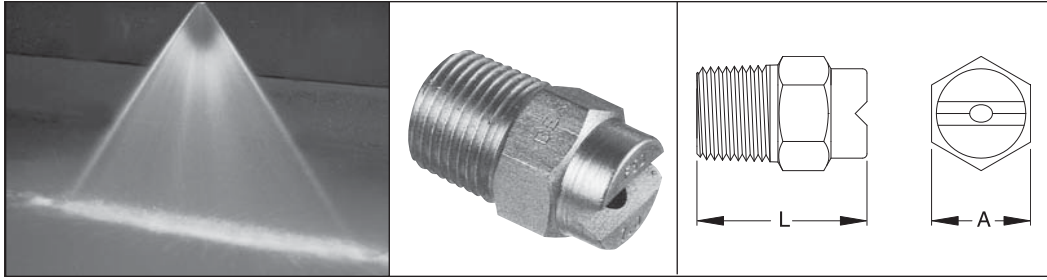

DIMENSIONS

PIPE SIZE (NPT)	Length L (inches)	Dim. A (inches)
1/8	13/16	7/16 HEX
1/4	15/16	9/16 HEX
3/8	1 3/16	1 1/16 HEX
1/2	1 5/16	7/8 HEX
3/4	1 11/16	1 1/16 HEX
1	2 1/2	1 3/8 HEX
1 1/4	3 5/8	1 3/4 HEX
1 1/2	4 1/4	2 Dia.
2	5	2 3/8 Dia.

ACCESSORIES:

Check Valves:

For use when a complete shut-off is required. See page 85 for details.

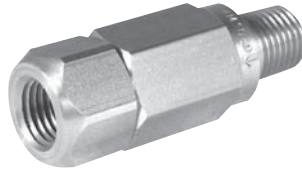

FLAT SPRAY

SPRAY ANGLE @ 40psi	MODEL NUMBER	PIPE SIZE NPT	EQUIV. ORIFICE DIAMETER (inches)	CAPACITY (GPM) AT VARIOUS PRESSURES (psi)													SPRAY ANGLE @		
				5 psi	7 psi	10 psi	15 psi	20 psi	30 psi	40 psi	50 psi	60 psi	80 psi	100 psi	150 psi	300 psi	20 psi	40 psi	80 psi
50°	1/8F5020	1/8	0.105	0.71	0.84	1.00	1.22	1.41	1.73	2.0	2.2	2.4	2.8	3.2	3.9	5.5	43°	50°	55°
	1/4F5020	1/4	0.105	0.71	0.84	1.00	1.22	1.41	1.73	2.0	2.2	2.4	2.8	3.2	3.9	5.5	43°	50°	55°
	3/8F5020	3/8	0.105	0.71	0.84	1.00	1.22	1.41	1.73	2.0	2.2	2.4	2.8	3.2	3.9	5.5	43°	50°	55°
	1/8F5030	1/8	0.129	1.06	1.25	1.50	1.84	2.1	2.6	3.0	3.4	3.7	4.2	4.7	5.8	8.2	43°	50°	54°
	1/4F5030	1/4	0.129	1.06	1.25	1.50	1.84	2.1	2.6	3.0	3.4	3.7	4.2	4.7	5.8	8.2	43°	50°	55°
	3/8F5030	3/8	0.129	1.06	1.25	1.50	1.84	2.1	2.6	3.0	3.4	3.7	4.2	4.7	5.8	8.2	43°	50°	54°
	1/8F5040	1/8	0.149	1.41	1.67	2.0	2.4	2.8	3.5	4.0	4.5	4.9	5.7	6.3	7.7	11.0	43°	50°	54°
	1/4F5040	1/4	0.149	1.41	1.67	2.0	2.4	2.8	3.5	4.0	4.5	4.9	5.7	6.3	7.7	11.0	43°	50°	54°
	3/8F5040	3/8	0.149	1.41	1.67	2.0	2.4	2.8	3.5	4.0	4.5	4.9	5.7	6.3	7.7	11.0	43°	50°	54°
	1/4F5050	1/4	0.167	1.77	2.1	2.5	3.1	3.5	4.3	5.0	5.6	6.1	7.1	7.9	9.7	13.7	43°	50°	53°
	3/8F5050	3/8	0.167	1.77	2.1	2.5	3.1	3.5	4.3	5.0	5.6	6.1	7.1	7.9	9.7	13.7	43°	50°	53°
	1/4F5060	1/4	0.182	2.1	2.5	3.0	3.7	4.2	5.2	6.0	6.7	7.3	8.5	9.5	11.6	16.4	43°	50°	53°
	3/8F5060	3/8	0.182	2.1	2.5	3.0	3.7	4.2	5.2	6.0	6.7	7.3	8.5	9.5	11.6	16.4	43°	50°	53°
	1/2F5060	1/2	0.182	2.1	2.5	3.0	3.7	4.2	5.2	6.0	6.7	7.3	8.5	9.5	11.6	16.4	43°	50°	53°
	1/4F5070	1/4	0.197	2.5	2.9	3.5	4.3	4.9	6.1	7.0	7.8	8.6	9.9	11.1	13.6	19.2	44°	50°	53°
	3/8F5070	3/8	0.197	2.5	2.9	3.5	4.3	4.9	6.1	7.0	7.8	8.6	9.9	11.1	13.6	19.2	44°	50°	53°
	1/2F5070	1/2	0.197	2.5	2.9	3.5	4.3	4.9	6.1	7.0	7.8	8.6	9.9	11.1	13.6	19.2	44°	50°	53°
	3/8F50100	3/8	0.236	3.5	4.2	5.0	6.1	7.1	8.7	10.0	11.2	12.2	14.1	15.8	19.4	27	44°	50°	52°
	1/2F50100	1/2	0.236	3.5	4.2	5.0	6.1	7.1	8.7	10.0	11.2	12.2	14.1	15.8	19.4	27	44°	50°	52°
	3/8F50120	3/8	0.258	4.2	5.0	6.0	7.3	8.5	10.4	12.0	13.4	14.7	17.0	19.0	23	33	44°	50°	53°
1/2F50120	1/2	0.258	4.2	5.0	6.0	7.3	8.5	10.4	12.0	13.4	14.7	17.0	19.0	23	33	44°	50°	53°	
3/8F50150	3/8	0.289	5.3	6.3	7.5	9.2	10.6	13.0	15.0	16.8	18.4	21	24	29	41	45°	50°	52°	
1/2F50150	1/2	0.289	5.3	6.3	7.5	9.2	10.6	13.0	15.0	16.8	18.4	21	24	29	41	45°	50°	52°	
1/2F50200	1/2	0.333	7.1	8.4	10.0	12.2	14.1	17.3	20	22	24	28	32	39	55	46°	50°	52°	
3/4F50200	3/4	0.333	7.1	8.4	10.0	12.2	14.1	17.3	20	22	24	28	32	39	55	46°	50°	52°	
3/4F50400	3/4	0.471	14.1	16.7	20	24	28	35	40	45	49	57	63	77	110	47°	50°	54°	
1F50500	1	0.527	17.7	21	25	31	35	43	50	56	61	71	79	97	137	46°	50°	55°	
1 1/4F50500	1 1/4	0.527	17.7	21	25	31	35	43	50	56	61	71	79	97	137	46°	50°	55°	
1 1/4F50750	1 1/4	0.645	27	31	38	46	53	65	75	84	92	106	119	145	205	46°	50°	54°	
1 1/4F501000	1 1/4	0.745	35	42	50	61	71	87	100	112	122	141	158	194	274	46°	50°	55°	

CONTINUED on next page...

SPRAY ANGLE @ 40psi	MODEL NUMBER	PIPE SIZE NPT	EQUIV. ORIFICE DIAMETER (inches)	CAPACITY (GPM) AT VARIOUS PRESSURES (psi)													SPRAY ANGLE @		
				5 psi	7 psi	10 psi	15 psi	20 psi	30 psi	40 psi	50 psi	60 psi	80 psi	100 psi	150 psi	300 psi	20 psi	40 psi	80 psi
40°	1/8F4010	1/8	0.075	0.35	0.42	0.50	0.61	0.71	0.87	1.00	1.12	1.22	1.41	1.58	1.94	2.7	30°	40°	43°
	1/4F4010	1/4	0.075	0.35	0.42	0.50	0.61	0.71	0.87	1.00	1.12	1.22	1.41	1.58	1.94	2.7	30°	40°	43°
	1/8F4015	1/8	0.091	0.53	0.63	0.75	0.92	1.06	1.30	1.50	1.68	1.84	2.1	2.4	2.9	4.1	35°	40°	41°
	1/4F4015	1/4	0.091	0.53	0.63	0.75	0.92	1.06	1.30	1.50	1.68	1.84	2.1	2.4	2.9	4.1	35°	40°	41°
	1/8F4020	1/8	0.105	0.71	0.84	1.00	1.22	1.41	1.73	2.0	2.2	2.4	2.8	3.2	3.9	5.5	33°	40°	43°
	1/2F4020	1/2	0.105	0.71	0.84	1.00	1.22	1.41	1.73	2.0	2.2	2.4	2.8	3.2	3.9	5.5	33°	40°	43°
	3/8F4020	3/8	0.105	0.71	0.84	1.00	1.22	1.41	1.73	2.0	2.2	2.4	2.8	3.2	3.9	5.5	33°	40°	43°
	1/8F4030	1/8	0.129	1.06	1.25	1.50	1.84	2.1	2.6	3.0	3.4	3.7	4.2	4.7	5.8	8.2	34°	40°	45°
	1/4F4030	1/4	0.129	1.06	1.25	1.50	1.84	2.1	2.6	3.0	3.4	3.7	4.2	4.7	5.8	8.2	34°	40°	45°
	3/8F4030	3/8	0.129	1.06	1.25	1.50	1.84	2.1	2.6	3.0	3.4	3.7	4.2	4.7	5.8	8.2	34°	40°	45°
	1/8F4040	1/8	0.149	1.41	1.67	2.0	2.4	2.8	3.5	4.0	4.5	4.9	5.7	6.3	7.7	11.0	33°	40°	43°
	1/4F4040	1/4	0.149	1.41	1.67	2.0	2.4	2.8	3.5	4.0	4.5	4.9	5.7	6.3	7.7	11.0	33°	40°	43°
	3/8F4040	3/8	0.149	1.41	1.67	2.0	2.4	2.8	3.5	4.0	4.5	4.9	5.7	6.3	7.7	11.0	33°	40°	43°
	1/4F4050	1/4	0.167	1.77	2.1	2.5	3.1	3.5	4.3	5.0	5.6	6.1	7.1	7.9	9.7	13.7	35°	40°	46°
	3/8F4050	3/8	0.167	1.77	2.1	2.5	3.1	3.5	4.3	5.0	5.6	6.1	7.1	7.9	9.7	13.7	35°	40°	46°
	1/4F4060	1/4	0.182	2.1	2.5	3.0	3.7	4.2	5.2	6.0	6.7	7.3	8.5	9.5	11.6	16.4	37°	40°	48°
	3/8F4060	3/8	0.182	2.1	2.5	3.0	3.7	4.2	5.2	6.0	6.7	7.3	8.5	9.5	11.6	16.4	37°	40°	48°
	1/2F4060	1/2	0.182	2.1	2.5	3.0	3.7	4.2	5.2	6.0	6.7	7.3	8.5	9.5	11.6	16.4	37°	40°	48°
	1/4F4070	1/4	0.197	2.5	2.9	3.5	4.3	4.9	6.1	7.0	7.8	8.6	9.9	11.1	13.6	19.2	35°	40°	46°
	3/8F4070	3/8	0.197	2.5	2.9	3.5	4.3	4.9	6.1	7.0	7.8	8.6	9.9	11.1	13.6	19.2	35°	40°	46°
	1/2F4070	1/2	0.197	2.5	2.9	3.5	4.3	4.9	6.1	7.0	7.8	8.6	9.9	11.1	13.6	19.2	35°	40°	44°
	3/8F40100	3/8	0.236	3.5	4.2	5.0	6.1	7.1	8.7	10.0	11.2	12.2	14.1	15.8	19.4	27	33°	40°	44°
	1/2F40100	1/2	0.236	3.5	4.2	5.0	6.1	7.1	8.7	10.0	11.2	12.2	14.1	15.8	19.4	27	33°	40°	44°
	3/4F40100	3/4	0.236	3.5	4.2	5.0	6.1	7.1	8.7	10.0	11.2	12.2	14.1	15.8	19.4	27	36°	40°	44°
	1/2F40120	1/2	0.258	4.2	5.0	6.0	7.3	8.5	10.4	12.0	13.4	14.7	17.0	19.0	23	33	36°	40°	43°
	1/2F40150	1/2	0.289	5.3	6.3	7.5	9.2	10.6	13.0	15.0	16.8	18.4	21	24	29	41	37°	40°	44°
	3/4F40150	3/4	0.289	5.3	6.3	7.5	9.2	10.6	13.0	15.0	16.8	18.4	21	24	29	41	37°	40°	44°
	1/2F40200	1/2	0.333	7.1	8.4	10.0	12.2	14.1	17.3	20	22	24	28	32	39	55	38°	40°	43°
	3/4F40200	3/4	0.333	7.1	8.4	10.0	12.2	14.1	17.3	20	22	24	28	32	39	55	38°	40°	43°
	3/4F40300	3/4	0.408	10.6	12.5	15.0	18.4	21	26	30	34	37	42	47	58	82	38°	40°	44°
3/4F40350	3/4	0.441	12.4	14.6	17.5	21	25	30	35	39	43	49	55	68	96	37°	40°	44°	
3/4F40400	3/4	0.471	14.1	16.7	20	24	28	35	40	45	49	57	63	77	110	38°	40°	44°	
25°	1/8F2510	1/8	0.075	0.35	0.42	0.50	0.61	0.71	0.87	1.00	1.12	1.22	1.41	1.58	1.94	2.7	17°	25°	31°
	1/4F2510	1/4	0.075	0.35	0.42	0.50	0.61	0.71	0.87	1.00	1.12	1.22	1.41	1.58	1.94	2.7	17°	25°	31°
	1/8F2515	1/8	0.091	0.53	0.63	0.75	0.92	1.06	1.30	1.50	1.68	1.84	2.1	2.4	2.9	4.1	18°	25°	30°
	1/4F2515	1/4	0.091	0.53	0.63	0.75	0.92	1.06	1.30	1.50	1.68	1.84	2.1	2.4	2.9	4.1	18°	25°	30°
	1/8F2520	1/8	0.105	0.71	0.84	1.00	1.22	1.41	1.73	2.0	2.2	2.4	2.8	3.2	3.9	5.5	18°	25°	28°
	1/4F2520	1/4	0.105	0.71	0.84	1.00	1.22	1.41	1.73	2.0	2.2	2.4	2.8	3.2	3.9	5.5	18°	25°	28°
	1/8F2530	1/8	0.129	1.06	1.25	1.50	1.84	2.1	2.6	3.0	3.4	3.7	4.2	4.7	5.8	8.2	19°	25°	29°
	1/4F2530	1/4	0.129	1.06	1.25	1.50	1.84	2.1	2.6	3.0	3.4	3.7	4.2	4.7	5.8	8.2	19°	25°	29°
	3/8F2530	3/8	0.129	1.06	1.25	1.50	1.84	2.1	2.6	3.0	3.4	3.7	4.2	4.7	5.8	8.2	19°	25°	29°
	1/8F2540	1/8	0.149	1.41	1.67	2.0	2.4	2.8	3.5	4.0	4.5	4.9	5.7	6.3	7.7	11.0	22°	25°	32°
	1/4F2540	1/4	0.149	1.41	1.67	2.0	2.4	2.8	3.5	4.0	4.5	4.9	5.7	6.3	7.7	11.0	22°	25°	32°
	3/8F2540	3/8	0.149	1.41	1.67	2.0	2.4	2.8	3.5	4.0	4.5	4.9	5.7	6.3	7.7	11.0	22°	25°	32°

FLAT SPRAY

F SERIES

Flat "V" spray nozzles continued

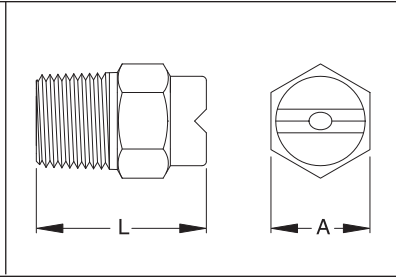
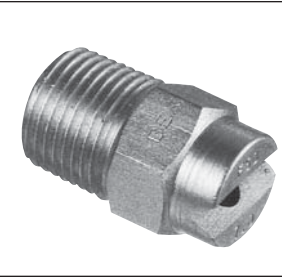
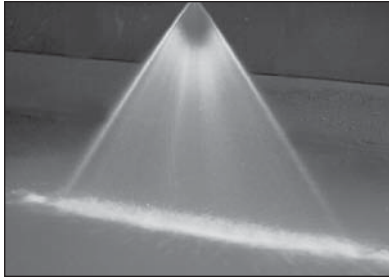

DIMENSIONS

PIPE SIZE (NPT)	Length L (inches)	Dim. A (inches)
1/8	13/16	7/16 HEX
1/4	15/16	9/16 HEX
3/8	1 3/16	1 1/16 HEX
1/2	1 5/16	7/8 HEX
3/4	1 11/16	1 1/16 HEX
1	2 1/2	1 3/8 HEX
1 1/4	3 5/8	1 3/4 HEX
1 1/2	4 1/4	2 Dia.
2	5	2 3/8 Dia.

ACCESSORIES:

A Flow Stabilizer may be required where nozzles are installed close to elbows or tees. See page 86 for this and other accessories.

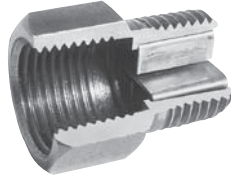

FLAT SPRAY

SPRAY ANGLE @ 40 psi	MODEL NUMBER	PIPE SIZE NPT	EQUIV. ORIFICE DIAMETER (inches)	CAPACITY (GPM) AT VARIOUS PRESSURES (psi)														SPRAY ANGLE @		
				5 psi	7 psi	10 psi	15 psi	20 psi	30 psi	40 psi	50 psi	60 psi	80 psi	100 psi	150 psi	300 psi	20 psi	40 psi	80 psi	
25°	1/4F2550	1/4	.167	1.77	2.1	2.5	3.1	3.5	4.3	5.0	5.6	6.1	7.1	7.9	9.7	13.7	20°	25°	32°	
	3/8F2550	3/8	.167	1.77	2.1	2.5	3.1	3.5	4.3	5.0	5.6	6.1	7.1	7.9	9.7	13.7	20°	25°	32°	
	1/4F2560	1/4	.182	2.1	2.5	3.0	3.7	4.2	5.2	6.0	6.7	7.3	8.5	9.5	11.6	16.4	18°	25°	28°	
	3/8F2560	3/8	.182	2.1	2.5	3.0	3.7	4.2	5.2	6.0	6.7	7.3	8.5	9.5	11.6	16.4	18°	25°	28°	
	1/4F2570	1/4	.197	2.5	2.9	3.5	4.3	4.9	6.1	7.0	7.8	8.6	9.9	11.1	13.6	19.2	19°	25°	27°	
	3/8F2570	3/8	.197	2.5	2.9	3.5	4.3	4.9	6.1	7.0	7.8	8.6	9.9	11.1	13.6	19.2	19°	25°	27°	
	3/8F25100	3/8	.236	3.5	4.2	5.0	6.1	7.1	8.7	10.0	11.2	12.2	14.1	15.8	19.4	27	21°	25°	28°	
	1/2F25100	1/2	.236	3.5	4.2	5.0	6.1	7.1	8.7	10.0	11.2	12.2	14.1	15.8	19.4	27	21°	25°	28°	
	1/2F25150	1/2	.289	5.3	6.3	7.5	9.2	10.6	13.0	15.0	16.8	18.4	21	24	29	41	18°	25°	28°	
	1/2F25200	1/2	.333	7.1	8.4	10.0	12.2	14.1	17.3	20	22	24	28	32	39	55	19°	25°	27°	
15°	1/8F1510	1/8	.075	0.35	0.42	0.50	0.61	0.71	0.87	1.00	1.12	1.22	1.41	1.58	1.94	2.7	13°	15°	16°	
	1/4F1510	1/4	.075	0.35	0.42	0.50	0.61	0.71	0.87	1.00	1.12	1.22	1.41	1.58	1.94	2.7	13°	15°	16°	
	1/8F1515	1/8	.091	0.53	0.63	0.75	0.92	1.06	1.30	1.50	1.68	1.84	2.1	2.4	2.9	4.1	11°	15°	20°	
	1/4F1515	1/4	.091	0.53	0.63	0.75	0.92	1.06	1.30	1.50	1.68	1.84	2.1	2.4	2.9	4.1	11°	15°	20°	
	3/8F1515	3/8	.091	0.53	0.63	0.75	0.92	1.06	1.30	1.50	1.68	1.84	2.1	2.4	2.9	4.1	11°	15°	20°	
	1/8F1520	1/8	.105	0.71	0.84	1.00	1.22	1.41	1.73	2.0	2.2	2.4	2.8	3.2	3.9	5.5	11°	15°	20°	
	1/4F1520	1/4	.105	0.71	0.84	1.00	1.22	1.41	1.73	2.0	2.2	2.4	2.8	3.2	3.9	5.5	11°	15°	20°	
	3/8F1520	3/8	.105	0.71	0.84	1.00	1.22	1.41	1.73	2.0	2.2	2.4	2.8	3.2	3.9	5.5	11°	15°	18°	
	1/8F1530	1/8	.129	1.06	1.25	1.50	1.84	2.1	2.6	3.0	3.4	3.7	4.2	4.7	5.8	8.2	11°	15°	18°	
	1/4F1530	1/4	.129	1.06	1.25	1.50	1.84	2.1	2.6	3.0	3.4	3.7	4.2	4.7	5.8	8.2	12°	15°	18°	
	3/8F1530	3/8	.129	1.06	1.25	1.50	1.84	2.1	2.6	3.0	3.4	3.7	4.2	4.7	5.8	8.2	12°	15°	18°	
	1/4F1540	1/4	.149	1.41	1.67	2.0	2.4	2.8	3.5	4.0	4.5	4.9	5.7	6.3	7.7	11.0	12°	15°	18°	
	3/8F1540	3/8	.149	1.41	1.67	2.0	2.4	2.8	3.5	4.0	4.5	4.9	5.7	6.3	7.7	11.0	12°	15°	19°	
	1/4F1550	1/4	.167	1.77	2.1	2.5	3.1	3.5	4.3	5.0	5.6	6.1	7.1	7.9	9.7	13.7	12°	15°	19°	
	3/8F1550	3/8	.167	1.77	2.1	2.5	3.1	3.5	4.3	5.0	5.6	6.1	7.1	7.9	9.7	13.7	12°	15°	19°	
	1/4F1560	1/4	.182	2.1	2.5	3.0	3.7	4.2	5.2	6.0	6.7	7.3	8.5	9.5	11.6	16.4	12°	15°	17°	
	3/8F1560	3/8	.182	2.1	2.5	3.0	3.7	4.2	5.2	6.0	6.7	7.3	8.5	9.5	11.6	16.4	12°	15°	17°	
	1/4F1570	1/4	.197	2.5	2.9	3.5	4.3	4.9	6.1	7.0	7.8	8.6	9.9	11.1	13.6	19.2	12°	15°	19°	
	3/8F1570	3/8	.197	2.5	2.9	3.5	4.3	4.9	6.1	7.0	7.8	8.6	9.9	11.1	13.6	19.2	12°	15°	19°	
	3/8F15100	3/8	.236	3.5	4.2	5.0	6.1	7.1	8.7	10.0	11.2	12.2	14.1	15.8	19.4	27	12°	15°	19°	
1/2F15100	1/2	.236	3.5	4.2	5.0	6.1	7.1	8.7	10.0	11.2	12.2	14.1	15.8	19.4	27	12°	15°	19°		
3/8F15120	3/8	.258	4.2	5.0	6.0	7.3	8.5	10.4	12.0	13.4	14.7	17.0	19.0	23	33	12°	15°	19°		
1/2F15120	1/2	.258	4.2	5.0	6.0	7.3	8.5	10.4	12.0	13.4	14.7	17.0	19.0	23	33	12°	15°	18°		
3/8F15150	3/8	.289	5.3	6.3	7.5	9.2	10.6	13.0	15.0	16.8	18.4	21	24	29	41	12°	15°	18°		
1/2F15150	1/2	.289	5.3	6.3	7.5	9.2	10.6	13.0	15.0	16.8	18.4	21	24	29	41	12°	15°	18°		
1/2F15200	1/2	.333	7.1	8.4	10.0	12.2	14.1	17.3	20	22	24	28	32	39	55	13°	15°	17°		

CONTINUED on next page...



ACCESSORIES:

Adjustable joints may be used to accurately orient a spray pattern. See page 84 for this and other accessories.



DIMENSIONS

PIPE SIZE (NPT)	Length L (inches)	Dim. A (inches)
1/8	13/16	7/16 HEX
1/4	15/16	9/16 HEX
3/8	13/16	11/16 HEX
1/2	15/16	7/8 HEX
3/4	1 11/16	1 1/16 HEX
1	2 1/2	1 3/8 HEX
1 1/4	3 5/8	1 3/4 HEX
1 1/2	4 1/4	2 Dia.
2	5	2 3/8 Dia.

SPRAY ANGLE @ 40 psi	MODEL NUMBER	PIPE SIZE NPT	EQUIV. ORIFICE DIAMETER (inches)	CAPACITY (GPM) AT VARIOUS PRESSURES (psi)												SPRAY ANGLE @			
				5 psi	7 psi	10 psi	15 psi	20 psi	30 psi	40 psi	50 psi	60 psi	80 psi	100 psi	150 psi	300 psi	20 psi	40 psi	80 psi
5°	1/8F0510	1/8	.075	0.35	0.42	0.50	0.61	0.71	0.87	1.00	1.12	1.22	1.41	1.58	1.94	2.7	5°	5°	8°
	1/4F0510	1/4	.075	0.35	0.42	0.50	0.61	0.71	0.87	1.00	1.12	1.22	1.41	1.58	1.94	2.7	5°	5°	8°
	1/8F0515	1/8	.091	0.53	0.63	0.75	0.92	1.06	1.30	1.50	1.68	1.84	2.1	2.4	2.9	4.1	5°	5°	9°
	1/4F0515	1/4	.091	0.53	0.63	0.75	0.92	1.06	1.30	1.50	1.68	1.84	2.1	2.4	2.9	4.1	5°	5°	9°
	3/8F0515	3/8	.091	0.53	0.63	0.75	0.92	1.06	1.30	1.50	1.68	1.84	2.1	2.4	2.9	4.1	5°	5°	9°
	1/8F0520	1/8	.105	0.71	0.84	1.00	1.22	1.41	1.73	2.0	2.2	2.4	2.8	3.2	3.9	5.5	5°	5°	9°
	1/4F0520	1/4	.105	0.71	0.84	1.00	1.22	1.41	1.73	2.0	2.2	2.4	2.8	3.2	3.9	5.5	5°	5°	9°
	3/8F0520	3/8	.105	0.71	0.84	1.00	1.22	1.41	1.73	2.0	2.2	2.4	2.8	3.2	3.9	5.5	5°	5°	9°
	1/8F0530	1/8	.129	1.06	1.25	1.50	1.84	2.1	2.6	3.0	3.4	3.7	4.2	4.7	5.8	8.2	5°	5°	9°
	1/4F0530	1/4	.129	1.06	1.25	1.50	1.84	2.1	2.6	3.0	3.4	3.7	4.2	4.7	5.8	8.2	5°	5°	9°
	3/8F0530	3/8	.129	1.06	1.25	1.50	1.84	2.1	2.6	3.0	3.4	3.7	4.2	4.7	5.8	8.2	5°	5°	9°
	1/4F0540	1/4	.149	1.41	1.67	2.0	2.4	2.8	3.5	4.0	4.5	4.9	5.7	6.3	7.7	11.0	5°	5°	9°
	3/8F0540	3/8	.149	1.41	1.67	2.0	2.4	2.8	3.5	4.0	4.5	4.9	5.7	6.3	7.7	11.0	5°	5°	9°
	1/4F0550	1/4	.167	1.77	2.1	2.5	3.1	3.5	4.3	5.0	5.6	6.1	7.1	7.9	9.7	13.7	5°	5°	10°
	3/8F0550	3/8	.167	1.77	2.1	2.5	3.1	3.5	4.3	5.0	5.6	6.1	7.1	7.9	9.7	13.7	5°	5°	10°
	1/4F0560	1/4	.182	2.1	2.5	3.0	3.7	4.2	5.2	6.0	6.7	7.3	8.5	9.5	11.6	16.4	5°	5°	10°
	3/8F0560	3/8	.182	2.1	2.5	3.0	3.7	4.2	5.2	6.0	6.7	7.3	8.5	9.5	11.6	16.4	5°	5°	10°
	1/4F0570	1/4	.197	2.5	2.9	3.5	4.3	4.9	6.1	7.0	7.8	8.6	9.9	11.1	13.6	19.2	5°	5°	10°
	3/8F0570	3/8	.197	2.5	2.9	3.5	4.3	4.9	6.1	7.0	7.8	8.6	9.9	11.1	13.6	19.2	5°	5°	10°
	3/8F05100	3/8	.236	3.5	4.2	5.0	6.1	7.1	8.7	10.0	11.2	12.2	14.1	15.8	19.4	27	5°	5°	19°
3/8F05120	3/8	.258	4.2	5.0	6.0	7.3	8.5	10.4	12.0	13.4	14.7	17.0	19.0	23	33	5°	5°	19°	
3/8F05150	3/8	.289	5.3	6.3	7.5	9.2	10.6	13.0	15.0	16.8	18.4	21	24	29	41	5°	5°	18°	

FLAT SPRAY

F SERIES

Solid stream spray nozzles

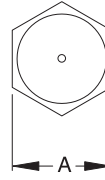
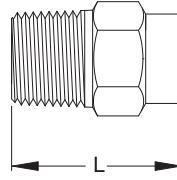

DIMENSIONS

PIPE SIZE (NPT)	Length L (inches)	Dim. A (inches)
1/8	13/16	7/16 HEX
1/4	15/16	9/16 HEX
3/8	1 3/16	1 1/16 HEX
1/2	1 5/16	7/8 HEX
3/4	1 11/16	1 1/8 HEX
1	2 1/2	1 3/8 HEX
1 1/4	3 5/8	1 3/4 HEX
1 1/2	4 1/4	2 Dia.
2	5	2 3/8 Dia.

SPRAY CHARACTERISTICS:

A high impact solid stream. For situations where maximum impact is required over a very small target area:

- Metal Wash
- Agitation
- Mixing

CONSTRUCTION:

The models listed are machined from bar stock, and are one piece construction. Standard materials are brass, steel, 303 stainless steel and 316 stainless steel. For molded plastic models, please see page 23.

FLAT SPRAY

SPRAY ANGLE @ 40psi	MODEL NUMBER	PIPE SIZE NPT	EQUIV. ORIFICE DIAMETER (inches)	CAPACITY (GPM) AT VARIOUS PRESSURES (psi)												SPRAY ANGLE @		
				5 psi	7 psi	10 psi	20 psi	30 psi	40 psi	60 psi	80 psi	100 psi	200 psi	300 psi	400 psi	500 psi	20 psi	40 psi
0°	1/8F0010	1/8	.075	0.35	0.42	0.50	0.71	0.87	1.00	1.22	1.41	1.58	2.2	2.7	3.2	3.5	0° Solid Stream	
	1/4F0010	1/4	.075	0.35	0.42	0.50	0.71	0.87	1.00	1.22	1.41	1.58	2.2	2.7	3.2	3.5		
	1/8F0015	1/8	.091	0.53	0.63	0.75	1.06	1.30	1.50	1.84	2.1	2.4	3.4	4.1	4.7	5.3		
	1/4F0015	1/4	.091	0.53	0.63	0.75	1.06	1.30	1.50	1.84	2.1	2.4	3.4	4.1	4.7	5.3		
	1/8F0020	1/8	.105	0.71	0.84	1.00	1.41	1.73	2.0	2.4	2.8	3.2	4.5	5.5	6.3	7.1		
	1/4F0020	1/4	.105	0.71	0.84	1.00	1.41	1.73	2.0	2.4	2.8	3.2	4.5	5.5	6.3	7.1		
	1/8F0030	1/8	.129	1.06	1.25	1.50	2.1	2.6	3.0	3.7	4.2	4.7	6.7	8.2	9.5	10.6		
	1/4F0030	1/4	.129	1.06	1.25	1.50	2.1	2.6	3.0	3.7	4.2	4.7	6.7	8.2	9.5	10.6		
	1/8F0040	1/8	.149	1.41	1.67	2.0	2.8	3.5	4.0	4.9	5.7	6.3	8.9	11.0	12.6	14.1		
	1/4F0040	1/4	.149	1.41	1.67	2.0	2.8	3.5	4.0	4.9	5.7	6.3	8.9	11.0	12.6	14.1		
	3/8F0040	3/8	.149	1.41	1.67	2.0	2.8	3.5	4.0	4.9	5.7	6.3	8.9	11.0	12.6	14.1		
	1/4F0050	1/4	.167	1.77	2.1	2.5	3.5	4.3	5.0	6.1	7.1	7.9	11.2	13.7	15.8	17.7		
	3/8F0050	3/8	.167	1.77	2.1	2.5	3.5	4.3	5.0	6.1	7.1	7.9	11.2	13.7	15.8	17.7		
	1/4F0060	1/4	.182	2.1	2.5	3.0	4.2	5.2	6.0	7.3	8.5	9.5	13.4	16.4	19.0	21		
	3/8F0060	3/8	.182	2.1	2.5	3.0	4.2	5.2	6.0	7.3	8.5	9.5	13.4	16.4	19.0	21		
	1/4F0070	1/4	.197	2.5	2.9	3.5	4.9	6.1	7.0	8.6	9.9	11.1	15.7	19.2	22	25		
	3/8F0070	3/8	.197	2.5	2.9	3.5	4.9	6.1	7.0	8.6	9.9	11.1	15.7	19.2	22	25		
	1/4F0080	1/4	.211	2.8	3.3	4.0	5.7	6.9	8.0	9.8	11.3	12.6	17.9	22	25	28		
	3/8F0080	3/8	.211	2.8	3.3	4.0	5.7	6.9	8.0	9.8	11.3	12.6	17.9	22	25	28		
	3/8F00100	3/8	.236	3.5	4.2	5.0	7.1	8.7	10.0	12.2	14.1	15.8	22	27	32	35		
	3/8F00120	3/8	.258	4.2	5.0	6.0	8.5	10.4	12.0	14.7	17.0	19.0	27	33	38	42		
	1/2F00120	1/2	.258	4.2	5.0	6.0	8.5	10.4	12.0	14.7	17.0	19.0	27	33	38	42		
	1/2F00150	1/2	.289	5.3	6.3	7.5	10.6	13.0	15.0	18.4	21	24	34	41	47	53		
	1/2F00200	1/2	.333	7.1	8.4	10.0	14.1	17.3	20	24	28	32	45	55	63	71		
	3/4F00250	3/4	.373	8.8	10.5	12.5	17.7	22	25	31	35	40	56	68	79	88		
	3/4F00350	3/4	.441	12.4	14.6	17.5	25	30	35	43	49	55	78	96	111	124		
	3/4F00400	3/4	.471	14.1	16.7	20	28	35	40	49	57	63	89	110	126	141		
	3/4F00500	3/4	.527	17.7	21	25	35	43	50	61	71	79	112	137	158	177		
	3/4F00700	3/4	.623	25	29	35	49	61	70	86	99	111	157	192	221	247		
	1F001000	1	.745	35	42	50	71	87	100	122	141	158	220	274	316	354		

Molded plastic spray nozzles

F SERIES

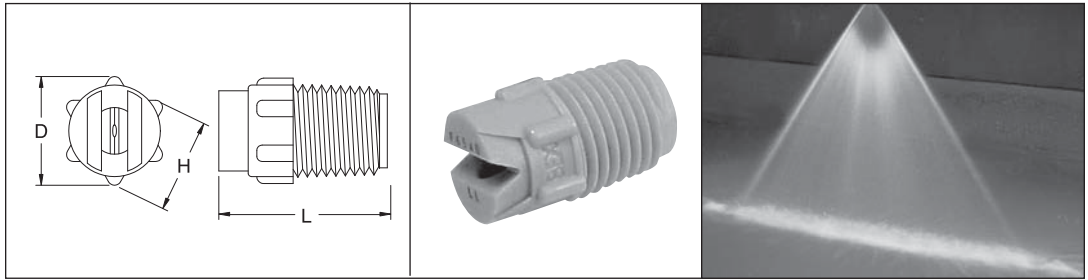

SPRAY CHARACTERISTICS:

BEX F series spray nozzles produce a flat spray pattern with spray angles of 0° to 110° @ 40 psi.

CONSTRUCTION:

Each BEX molded nozzle is designed with a series of "knobs" which makes them easier to finger tighten than a hex, especially when wet. The design feature of a small starter barrel greatly reduces the tendency to strip or cross-thread the nozzle during the installation.

MATERIALS AVAILABLE:

POLYPROPYLENE (LL) - (Green) excellent chemical and corrosion resistance. Useful up to 175°F.

NATURAL POLYPROPYLENE (LN) - non-pigmented for optimum purity.

PVDF (KK) - (Red) excellent durability and abrasion resistance and is inert to most chemicals. Useful up to 300°F.

NATURAL PVDF (KN) - non-pigmented for optimum purity.

DIMENSIONS

NOZZLE TYPE	Dim. D	Dim. H	Dim. L
1/8F	0.62	9/16	0.8
1/4F	0.62	9/16	1.0
3/8F	0.77	11/16	1.0

TYPICAL APPLICATIONS:

- Printed Circuit Board Washing
- PCB-Etching/Developing
- Semiconductor Manufacturing
- Pressure Washers
- Car Washing
- Street Sweeping
- Carpet Cleaning
- Fruit and Vegetable Washing
- Plating Processes
- Dust Suppression
- Acid Spraying
- Degreasing
- Coating Applications
- Foam Control
- Metal Washing
- Chemical Spraying
- Rinsing Parts

FLAT SPRAY

	SPRAY ANGLES @ 40 psi									CAPACITY (GPM)	
	0°	15°	25°	40°	50°	65°	80°	95°	110°	@ 10 psi	@ 40 psi
1/8" MODELS	1/8F0002	1/8F1502	1/8F2502	1/8F4002	1/8F5002	1/8F6502	1/8F8002	1/8F9502	1/8F11002	0.10	0.2
	1/8F0025	1/8F15025	1/8F25025	1/8F40025	1/8F50025	1/8F65025	1/8F80025	1/8F95025	1/8F110025	0.13	0.25
	1/8F0003	1/8F1503	1/8F2503	1/8F4003	1/8F5003	1/8F6503	1/8F8003	1/8F9503	1/8F11003	0.15	0.3
	1/8F0004	1/8F1504	1/8F2504	1/8F4004	1/8F5004	1/8F6504	1/8F8004	1/8F9504	1/8F11004	0.20	0.4
	1/8F0005	1/8F1505	1/8F2505	1/8F4005	1/8F5005	1/8F6505	1/8F8005	1/8F9505	1/8F11005	0.25	0.5
	1/8F0006	1/8F1506	1/8F2506	1/8F4006	1/8F5006	1/8F6506	1/8F8006	1/8F9506	1/8F11006	0.30	0.6
	1/8F0007	1/8F1507	1/8F2507	1/8F4007	1/8F5007	1/8F6507	1/8F8007	1/8F9507	1/8F11007	0.35	0.7
	1/8F0008	1/8F1508	1/8F2508	1/8F4008	1/8F5008	1/8F6508	1/8F8008	1/8F9508	1/8F11008	0.40	0.8
	1/8F0010	1/8F1510	1/8F2510	1/8F4010	1/8F5010	1/8F6510	1/8F8010	1/8F9510	1/8F11010	0.50	1.0
	1/8F0015	1/8F1515	1/8F2515	1/8F4015	1/8F5015	1/8F6515	1/8F8015	1/8F9515	1/8F11015	0.75	1.5
	1/8F0020	1/8F1520	1/8F2520	1/8F4020	1/8F5020	1/8F6520	1/8F8020	1/8F9520	1/8F11020	1.00	2.0
	1/4" MODELS	1/4F0002	1/4F1502	1/4F2502	1/4F4002	1/4F5002	1/4F6502	1/4F8002	1/4F9502	1/4F11002	0.10
1/4F0003		1/4F1503	1/4F2503	1/4F4003	1/4F5003	1/4F6503	1/4F8003	1/4F9503	1/4F11003	0.15	0.3
1/4F0004		1/4F1504	1/4F2504	1/4F4004	1/4F5004	1/4F6504	1/4F8004	1/4F9504	1/4F11004	0.20	0.4
1/4F0005		1/4F1505	1/4F2505	1/4F4005	1/4F5005	1/4F6505	1/4F8005	1/4F9505	1/4F11005	0.25	0.5
1/4F0006		1/4F1506	1/4F2506	1/4F4006	1/4F5006	1/4F6506	1/4F8006	1/4F9506	1/4F11006	0.30	0.6
1/4F0008		1/4F1508	1/4F2508	1/4F4008	1/4F5008	1/4F6508	1/4F8008	1/4F9508	1/4F11008	0.40	0.8
1/4F0010		1/4F1510	1/4F2510	1/4F4010	1/4F5010	1/4F6510	1/4F8010	1/4F9510	1/4F11010	0.50	1.0
1/4F0015		1/4F1515	1/4F2515	1/4F4015	1/4F5015	1/4F6515	1/4F8015	1/4F9515	1/4F11015	0.75	1.5
1/4F0020		1/4F1520	1/4F2520	1/4F4020	1/4F5020	1/4F6520	1/4F8020	1/4F9520	1/4F11020	1.00	2.0
1/4F0030		1/4F1530	1/4F2530	1/4F4030	1/4F5030	1/4F6530	1/4F8030	1/4F9530	1/4F11030	1.50	3.0
1/4F0040		1/4F1540	1/4F2540	1/4F4040	1/4F5040	1/4F6540	1/4F8040	1/4F9540	1/4F11040	2.00	4.0
1/4F0050		1/4F1550	1/4F2550	1/4F4050	1/4F5050	1/4F6550	1/4F8050	1/4F9550	1/4F11050	2.50	5.0
1/4F0060	1/4F1560	1/4F2560	1/4F4060	1/4F5060	1/4F6560	1/4F8060	1/4F9560	1/4F11060	3.00	6.0	
1/4F0070	1/4F1570	1/4F2570	1/4F4070	1/4F5070	1/4F6570	1/4F8070	1/4F9570	1/4F11070	3.50	7.0	
3/8" MODELS	3/8F0010	3/8F1510	3/8F2510	3/8F4010	3/8F5010	3/8F6510	3/8F8010	3/8F9510	3/8F11010	0.50	1.0
	3/8F0015	3/8F1515	3/8F2515	3/8F4015	3/8F5015	3/8F6515	3/8F8015	3/8F9515	3/8F11015	0.75	1.5
	3/8F0020	3/8F1520	3/8F2520	3/8F4020	3/8F5020	3/8F6520	3/8F8020	3/8F9520	3/8F11020	1.00	2.0
	3/8F0030	3/8F1530	3/8F2530	3/8F4030	3/8F5030	3/8F6530	3/8F8030	3/8F9530	3/8F11030	1.50	3.0
	3/8F0040	3/8F1540	3/8F2540	3/8F4040	3/8F5040	3/8F6540	3/8F8040	3/8F9540	3/8F11040	2.00	4.0
	3/8F0050	3/8F1550	3/8F2550	3/8F4050	3/8F5050	3/8F6550	3/8F8050	3/8F9550	3/8F11050	2.50	5.0
	3/8F0060	3/8F1560	3/8F2560	3/8F4060	3/8F5060	3/8F6560	3/8F8060	3/8F9560	3/8F11060	3.00	6.0
	3/8F0070	3/8F1570	3/8F2570	3/8F4070	3/8F5070	3/8F6570	3/8F8070	3/8F9570	3/8F11070	3.50	7.0

ABO Series

Air Blow-off nozzles

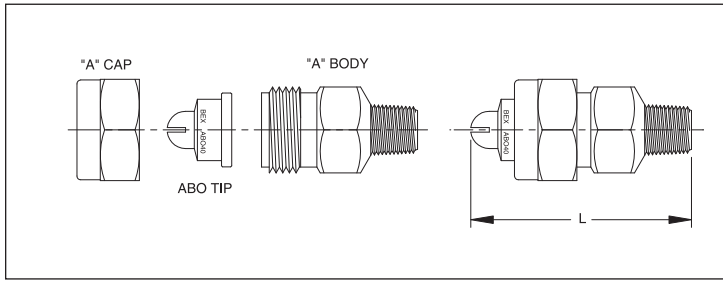

Also available in one-piece BEX 'ABP' style



SPRAY CHARACTERISTICS:

ABO Series air blow-off nozzles project a flat fan-shaped curtain of gas in a direction parallel to the axis of the nozzle body. Gases most commonly used are air and steam. ABO nozzles are designed with large maximum free passage sizes to reduce clogging and minimize the effects of minor tip damage.

CONSTRUCTION:

ABO assemblies comprise a body, a retaining cap and a nozzle tip. Standard materials are brass, 303 stainless steel and 316 stainless steel. Other materials are available on request.

SPECIAL FEATURES:

- Large maximum free passage
- Wider, more uniform coverage
- Easy assembly/disassembly and cleaning

TYPICAL APPLICATIONS:

- Cooling of Components/Parts
- Debris Removal
- Cleaning and Drying of Parts
- Small Gas Curtains

Also available in the AirWisk style. Please see page 86.



DIMENSIONS

MODEL NUMBER	PIPE SIZE (NPT)	OVERALL LENGTH (L)
1/8 ABO	1/8	1.77
1/4 ABO	1/4	1.83
3/8 ABO	3/8	1.90

MODEL NUMBER	SLOT WIDTH (inches)	AIR CAPACITY (S.C.F.M.)				STEAM CAPACITY (lbs/hr)				DISTANCE FROM NOZZLE (inches)	APPROX. WIDTH OF AIR COVERAGE (inches)							
		10 psi	20 psi	60 psi	100 psi	10 psi	20 psi	60 psi	100 psi		5 psi	10 psi	20 psi	40 psi	60 psi	80 psi	100 psi	
ABO16	0.016	0.67	1.10	2.4	3.6	1.20	2.3	5.0	7.6	2	5	5	6	8	9	10	10	
										4	7	8	9	12	14	16	16	
										6	9	10	11	16	19	22	23	
										10	10	13	15	21	25	28	29	
										20	12	16	20	32	35	39	40	
ABO20	0.020	1.40	2.0	4.3	6.6	2.9	4.5	9.7	14.9	2	5	6	7	9	10	11	11	
										4	8	10	12	13	16	17	17	
										6	10	13	16	18	21	24	24	
										10	15	20	24	25	29	30	30	
										20	24	28	31	33	38	41	42	
ABO28	0.028	2.3	3.5	7.5	11.6	5.0	7.9	17.0	26	2	6	6	6	9	11	12	14	
										4	8	9	9	14	16	18	23	
										6	10	12	12	18	21	25	29	
										10	15	17	18	26	29	34	37	
										20	24	29	30	38	44	48	51	
ABO40	0.040	4.2	6.0	12.9	19.8	9.0	13.0	28	43	2	7	8	8	11	11	12	12	
										4	11	11	12	17	18	22	22	
										6	13	13	16	23	24	29	30	
										10	15	17	23	31	32	38	42	
										20	22	28	40	45	46	50	55	
ABO51	0.051	7.1	11.0	24	36	16.0	24	52	79	2	87	9	10	13	14	16	23	
										4	12	15	16	21	24	28	32	
										6	16	20	22	28	34	38	43	
										10	24	29	30	40	46	49	53	
										20	36	41	43	55	62	62	63	
ABO72	0.072	13.0	19.0	41	63	27	43	93	142	2	7	9	12	16	20	22	23	
										4	11	13	15	25	22	36	37	
										6	14	17	19	34	41	45	47	
										10	20	24	26	45	55	49	62	
										20	33	39	41	55	70	74	76	

FLAT SPRAY

Flat "V" spray nozzles

STF Series

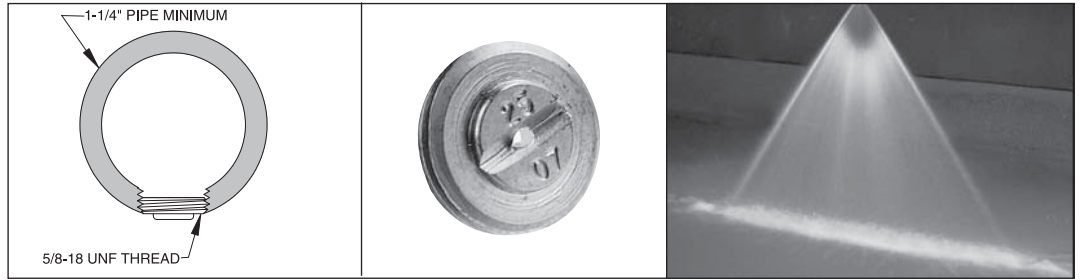

SPRAY CHARACTERISTICS:

STF spray nozzles produce a flat, fan-shaped spray pattern, similar to the F Series. Spray angles are available for a 0° solid stream to 90°, measured at 40 psi. Spray angles generally increase with pressure, as shown in the capacity table below.

Spray density tapers off toward the outside edges of these sprays, to permit overlapping of spray patterns while maintaining uniform spray density.

CONSTRUCTION:

The STF are disc-shaped, with a male 5/8-18 straight thread. They are machined from bar stock, and are one piece construction. Standard materials are 303 stainless steel and 316 stainless steel. Some models are also available in other materials.

TYPICAL APPLICATIONS:

The STF series is designed for applications where space is at a minimum, or where the nozzles must not protrude from the header. Typically the outer surface of the nozzle is flush with the outside of the header.

(NOTE: Certain models will protrude slightly).

FLAT SPRAY

SPRAY ANGLE @ 40psi	MODEL NUMBER	EQUIV. ORIFICE DIAMETER (inches)	CAPACITY (GPM) AT VARIOUS PRESSURES (psi)													SPRAY ANGLE @		
			10 psi	15 psi	20 psi	30 psi	40 psi	50 psi	60 psi	80 psi	100 psi	150 psi	200 psi	250 psi	300 psi	20 psi	40 psi	80 psi
0°	STF0003	0.041	0.15	0.18	0.21	0.26	0.30	0.34	0.37	0.42	0.47	0.58	0.67	0.75	0.82	0°	0°	0°
	STF0007	0.062	0.35	0.43	0.49	0.61	0.70	0.78	0.86	0.99	1.11	1.36	1.57	1.75	1.92	0°	0°	0°
25°	STF2507	0.062	0.35	0.43	0.49	0.61	0.70	0.78	0.86	0.99	1.11	1.36	1.57	1.75	1.92	19°	25°	26°
50°	STF50084	0.068	0.42	0.51	0.59	0.73	0.84	0.94	1.03	1.19	1.33	1.63	1.88	2.1	2.3	42°	50°	57°
	STF5013	0.085	0.65	0.80	0.92	1.13	1.30	1.45	1.59	1.84	2.1	2.5	2.9	3.3	3.6	44°	50°	56°
	STF5019	0.102	0.95	1.16	1.34	1.65	1.90	2.1	2.3	2.7	3.0	3.7	4.2	4.8	5.2	45°	50°	54°
60°	STF6003	0.041	0.15	0.18	0.21	0.26	0.30	0.34	0.37	0.42	0.47	0.58	0.67	0.75	0.82	50°	60°	65°
	STF50054	0.055	0.27	0.33	0.38	0.47	0.54	0.60	0.66	0.76	0.85	1.05	1.21	1.35	1.48	52°	60°	64°
	STF60093	0.072	0.47	0.57	0.66	0.81	0.93	1.04	1.14	1.32	1.47	1.80	2.1	2.3	2.5	56°	60°	66°
	STF6013	0.085	0.65	0.80	0.92	1.13	1.30	1.45	1.59	1.84	2.1	2.5	2.9	3.3	3.6	55°	60°	64°
	STF6020	0.105	1.00	1.22	1.41	1.73	2.0	2.2	2.4	2.8	3.2	3.9	4.5	5.0	5.5	55°	60°	63°
	STF6024	0.115	1.20	1.47	1.70	2.1	2.4	2.7	2.9	3.4	3.8	4.6	5.4	6.0	6.6	58°	60°	66°
	STF6033	0.135	1.65	2.0	2.3	2.9	3.3	3.7	4.0	4.7	5.2	6.4	7.4	8.3	9.0	58°	60°	64°
	STF6040	0.148	2.0	2.4	2.8	3.5	4.0	4.5	4.9	5.7	6.3	7.7	8.9	10	11	57°	60°	62°
	STF6047	0.161	2.4	2.9	3.3	4.1	4.7	5.3	5.8	6.6	7.4	9.1	10.5	11.8	12.9	58°	60°	62°
STF6088	0.220	4.4	5.4	6.2	7.6	8.8	9.8	10.8	12.4	13.9	17.0	19.7	22	24	58°	60°	62°	
65°	STF65054	0.055	0.27	0.33	0.38	0.47	0.54	0.60	0.66	0.76	0.85	1.05	1.21	1.35	1.48	55°	65°	72°
	STF6513	0.085	0.65	0.80	0.92	1.13	1.30	1.45	1.59	1.84	2.1	2.5	2.9	3.3	3.6	57°	65°	70°
	STF6519	0.102	0.95	1.16	1.34	1.65	1.90	2.1	2.3	2.7	3.0	3.7	4.2	4.8	5.2	60°	65°	69°
	STF6520	0.105	1.00	1.22	1.41	1.73	2.0	2.2	2.4	2.8	3.2	3.9	4.5	5.0	5.5	62°	65°	69°
	STF6524	0.115	1.20	1.47	1.70	2.1	2.4	2.7	2.9	3.4	3.8	4.6	5.4	6.0	6.6	62°	65°	67°
	STF6588	0.220	4.4	5.4	6.2	7.6	8.8	9.8	10.8	12.4	13.9	17.0	19.7	22	24	61°	65°	69°
68°	STF6824	0.115	1.20	1.47	1.70	2.1	2.4	2.7	2.9	3.4	3.8	4.6	5.4	6.0	6.6	65°	68°	70°
80°	STF8004	0.047	0.20	0.24	0.28	0.35	0.40	0.45	0.49	0.57	0.63	0.77	0.89	1.00	1.10	75°	80°	84°
	STF80054	0.055	0.27	0.33	0.38	0.47	0.54	0.60	0.66	0.76	0.85	1.05	1.21	1.35	1.48	72°	80°	87°
	STF80084	0.068	0.41	0.50	0.58	0.71	0.82	0.92	1.00	1.16	1.30	1.59	1.83	2.1	2.2	76°	80°	84°
	STF80093	0.072	0.47	0.57	0.66	0.81	0.93	1.04	1.14	1.32	1.47	1.80	2.1	2.3	2.5	74°	80°	84°
	STF8010	0.074	0.50	0.61	0.71	0.87	1.00	1.12	1.22	1.41	1.58	1.94	2.2	2.5	2.7	75°	80°	86°
	STF8013	0.085	0.65	0.80	0.92	1.13	1.30	1.45	1.59	1.84	2.1	2.5	2.9	3.3	3.6	76°	80°	85°
	STF8024	0.115	1.20	1.47	1.70	2.1	2.4	2.7	2.9	3.4	3.8	4.6	5.4	6.0	6.6	75°	80°	83°
	STF8033	0.135	1.65	2.0	2.3	2.9	3.3	3.7	4.0	4.7	5.2	6.4	7.4	8.3	9.0	76°	80°	82°
90°	STF90054	0.055	0.27	0.33	0.38	0.47	0.54	0.60	0.66	0.76	0.85	1.05	1.21	1.35	1.48	82°	90°	96°
	STF90093	0.072	0.47	0.57	0.66	0.81	0.93	1.04	1.14	1.32	1.47	1.80	2.1	2.3	2.5	83°	90°	95°
	STF9013	0.085	0.65	0.80	0.92	1.13	1.30	1.45	1.59	1.84	2.1	2.5	2.9	3.3	3.6	85°	90°	93°

DF Series

Threaded disc flat "V" spray nozzles (low profile)

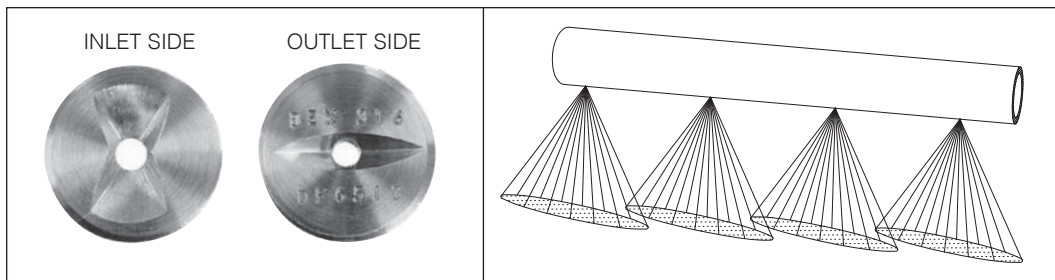

5/8-18 UNF THREAD

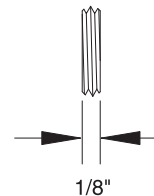

SPRAY CHARACTERISTICS:

These thin-disc flat spray nozzles are used where the nozzle must not project beyond the wall of the header pipe. Minimum recommended pipe size is 1" schedule 80. Optimum thread engagement occurs on pipes of 1-1/4" schedule 80 and larger. Usual operating pressures are up to 150 psi.

CONSTRUCTION:

Standard materials of construction are 316 stainless steel and 303 stainless steel. Other materials and capacities can be supplied.

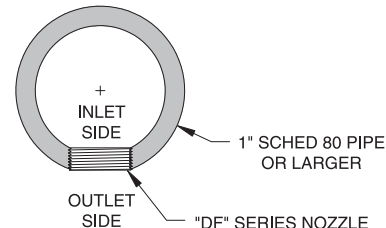

FLAT SPRAY

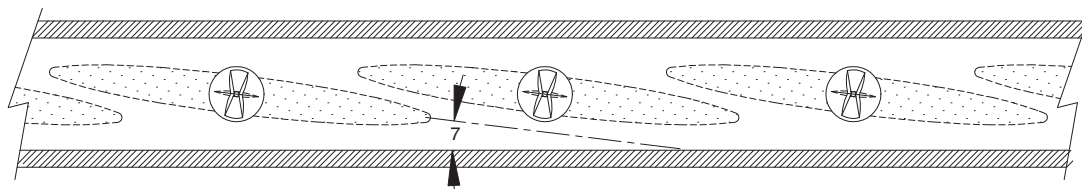

10 - 15% overlap is recommended for complete coverage

MODEL NUMBER	EQUIV. ORIFICE DIAMETER (inches)	CAPACITY (GPM) AT VARIOUS PRESSURES (psi)										SPRAY ANGLE @ 40 psi
		10 psi	15 psi	20 psi	30 psi	40 psi	50 psi	60 psi	80 psi	100 psi	150 psi	
DF35054	0.055	0.27	0.33	0.38	0.47	0.54	0.60	0.66	0.76	0.85	1.05	35°
DF3513	0.085	0.65	0.80	0.92	1.13	1.30	1.45	1.59	1.84	2.1	2.5	35°
DF3524	0.115	1.20	1.47	1.70	2.1	2.4	2.7	2.9	3.4	3.8	4.6	35°
DF3533	0.135	1.65	2.0	2.3	2.9	3.3	3.7	4.0	4.7	5.2	6.4	35°
DF4013	0.085	0.65	0.80	0.92	1.13	1.30	1.45	1.59	1.84	2.1	2.5	40°
DF4047	0.161	2.4	2.9	3.3	4.1	4.7	5.3	5.8	6.6	7.4	9.1	40°
DF4313	0.085	0.65	0.80	0.92	1.13	1.30	1.45	1.59	1.84	2.1	2.5	43°
DF5013	0.085	0.65	0.80	0.92	1.13	1.30	1.45	1.59	1.84	2.1	2.5	50°
DF55054	0.055	0.27	0.33	0.38	0.47	0.54	0.60	0.66	0.76	0.85	1.05	55°
DF55084	0.068	0.42	0.51	0.59	0.73	0.84	0.94	1.03	1.19	1.33	1.63	55°
DF5513	0.085	0.65	0.80	0.92	1.13	1.30	1.45	1.59	1.84	2.1	2.5	55°
DF5824	0.115	1.20	1.47	1.70	2.1	2.4	2.7	2.9	3.4	3.8	4.6	58°
DF5833	0.135	1.65	2.0	2.3	2.9	3.3	3.7	4.0	4.7	5.2	6.4	58°
DF6022	0.110	1.10	1.35	1.56	1.91	2.2	2.5	2.7	3.1	3.5	4.3	60°
DF65054	0.055	0.27	0.33	0.38	0.47	0.54	0.60	0.66	0.76	0.85	1.05	65°
DF6513	0.085	0.65	0.80	0.92	1.13	1.30	1.45	1.59	1.84	2.1	2.5	65°
DF6515	0.091	0.75	0.92	1.06	1.30	1.50	1.68	1.84	2.1	2.4	2.9	65°
DF6519	0.102	0.95	1.16	1.34	1.65	1.90	2.1	2.3	2.7	3.0	3.7	65°
DF6524	0.115	1.20	1.47	1.70	2.1	2.4	2.7	2.9	3.4	3.8	4.6	65°
DF6840	0.148	2.0	2.4	2.8	3.5	4.0	4.5	4.9	5.7	6.3	7.7	68°
DF70054	0.055	0.27	0.33	0.38	0.47	0.54	0.60	0.66	0.76	0.85	1.05	70°
DF80054	0.055	0.27	0.33	0.38	0.47	0.54	0.60	0.66	0.76	0.85	1.05	80°
DF80084	0.068	0.42	0.51	0.59	0.73	0.84	0.94	1.03	1.19	1.33	1.63	80°
DF8013	0.085	0.65	0.80	0.92	1.13	1.30	1.45	1.59	1.84	2.1	2.5	80°
DF8019	0.102	0.95	1.16	1.34	1.65	1.90	2.1	2.3	2.7	3.0	3.7	80°
DF8024	0.115	1.20	1.47	1.70	2.1	2.4	2.7	2.9	3.4	3.8	4.6	80°
DF8033	0.135	1.65	2.0	2.3	2.9	3.3	3.7	4.0	4.7	5.2	6.4	80°
DF90054	0.055	0.27	0.33	0.38	0.47	0.54	0.60	0.66	0.76	0.85	1.05	90°
DF11006	0.058	0.30	0.37	0.42	0.52	0.60	0.67	0.73	0.85	0.95	1.16	110°

Flooding nozzles

FL Series

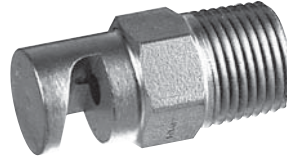
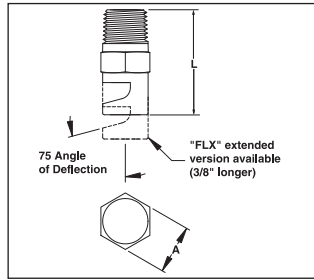

SPRAY CHARACTERISTICS:

A wide, flat fan-shaped spray with low impact. The spray is deflected 75° away from the centerline of the pipe connection, as shown.

CONSTRUCTION:

The models listed are machined from bar stock, and are one piece construction. Standard materials are brass, 303 stainless

steel and 316 stainless steel. Some models are also available in other materials, such as PVC, CPVC, Teflon® and polypropylene.



TYPICAL APPLICATIONS:

Wherever a low impact, wide angle spray is required.

- Rinsing and Cooling
- Dishwashing
- Fertilizer Spraying
- Metal Wash

FLAT SPRAY

MODEL NUMBER	PIPE SIZE NPT	ORIFICE DIA. (inches)	DIMENSIONS		CAPACITY (GPM) AT VARIOUS PRESSURES (psi)										SPRAY ANGLE @					
			A	L	3 psi	5 psi	7 psi	10 psi	15 psi	20 psi	30 psi	40 psi	60 psi	3 psi	5 psi	7 psi	10 psi	20 psi	60 psi	
1/8FL.25	1/8	0.017	7/16 Hex	9/16	--	--	--	0.03	0.03	0.04	0.04	0.05	0.06	--	--	--	90°	106°	120°	
1/8FL.50	1/8	0.024	7/16 Hex	9/16	--	--	0.04	0.05	0.06	0.07	0.09	0.10	0.12	--	--	65°	78°	99°	120°	
1/8FL.75	1/8	0.029	7/16 Hex	13/16	--	--	0.06	0.08	0.09	0.11	0.13	0.15	0.18	--	--	72°	85°	112°	140°	
1/8FL1	1/8	0.033	7/16 Hex	13/16	--	--	0.08	0.10	0.12	0.14	0.17	0.20	0.24	--	--	90°	97°	135°	148°	
1/8FL1.3	1/8	0.038	7/16 Hex	13/16	--	0.09	0.11	0.13	0.16	0.18	0.23	0.26	0.32	--	73°	80°	92°	115°	134°	
1/8FL1.5	1/8	0.042	7/16 Hex	13/16	0.08	0.11	0.13	0.15	0.18	0.21	0.26	0.30	0.37	57°	69°	75°	87°	104°	125°	
1/8FL2	1/8	0.047	7/16 Hex	13/16	0.11	0.14	0.17	0.20	0.24	0.28	0.35	0.40	0.49	60°	73°	82°	86°	104°	125°	
1/8FL2.5	1/8	0.055	7/16 Hex	13/16	0.14	0.18	0.21	0.25	0.31	0.36	0.44	0.51	0.62	79°	87°	92°	101°	112°	130°	
1/8FL3	1/8	0.059	7/16 Hex	13/16	0.16	0.21	0.25	0.30	0.37	0.42	0.52	0.60	0.73	84°	97°	106°	115°	130°	140°	
1/8FL4	1/8	0.070	7/16 Hex	15/16	0.22	0.28	0.33	0.40	0.49	0.57	0.69	0.80	0.98	74°	87°	89°	101°	116°	127°	
1/8FL5	1/8	0.076	7/16 Hex	15/16	0.27	0.35	0.42	0.50	0.61	0.71	0.87	1.00	1.22	78°	89°	97°	103°	113°	132°	
1/8FL7.5	1/8	0.094	7/16 Hex	15/16	0.41	0.53	0.63	0.75	0.92	1.06	1.30	1.50	1.84	98°	105°	112°	120°	132°	144°	
1/8FL10	1/8	0.110	7/16 Hex	15/16	0.55	0.71	0.84	1.00	1.22	1.41	1.73	2.0	2.4	116°	125°	135°	137°	144°	150°	
1/8FL12	1/8	0.120	9/16 Hex	1 1/16	0.66	0.85	1.00	1.20	1.47	1.70	2.1	2.4	2.9	98°	105°	109°	118°	134°	139°	
1/8FL15	1/8	0.129	9/16 Hex	1 1/16	0.82	1.06	1.25	1.50	1.84	2.1	2.6	3.0	3.7	100°	110°	115°	124°	131°	139°	
1/8FL18	1/8	0.147	9/16 Hex	1 1/16	0.99	1.27	1.51	1.80	2.2	2.5	3.1	3.6	4.4	100°	112°	116°	124°	135°	137°	
1/8FL20	1/8	0.154	9/16 Hex	1 1/16	1.10	1.41	1.67	2.0	2.4	2.8	3.5	4.0	4.9	115°	125°	128°	134°	142°	147°	
1/4FL1.3	1/4	0.038	9/16 Hex	15/16	0.07	0.09	0.11	0.13	0.16	0.18	0.23	0.26	0.32	52°	62°	71°	81°	97°	116°	
1/4FL1.5	1/4	0.042	9/16 Hex	15/16	0.08	0.11	0.13	0.15	0.18	0.21	0.26	0.30	0.37	57°	70°	77°	85°	103°	122°	
1/4FL2	1/4	0.047	9/16 Hex	15/16	0.11	0.14	0.17	0.20	0.24	0.28	0.35	0.40	0.49	62°	76°	84°	96°	110°	134°	
1/4FL2.5	1/4	0.055	9/16 Hex	15/16	0.14	0.18	0.21	0.25	0.31	0.35	0.43	0.50	0.61	88°	110°	114°	126°	145°	152°	
1/4FL3	1/4	0.059	9/16 Hex	15/16	0.16	0.21	0.25	0.30	0.37	0.42	0.52	0.60	0.73	77°	91°	99°	104°	128°	149°	
1/4FL4	1/4	0.070	9/16 Hex	1	0.22	0.28	0.33	0.40	0.49	0.57	0.69	0.80	0.98	65°	73°	82°	87°	96°	104°	
1/4FL5	1/4	0.076	9/16 Hex	1	0.27	0.35	0.42	0.50	0.61	0.71	0.87	1.00	1.22	69°	84°	89°	97°	107°	124°	
1/4FL7.5	1/4	0.094	9/16 Hex	1	0.41	0.53	0.63	0.75	0.92	1.06	1.30	1.50	1.84	90°	104°	122°	133°	145°	150°	
1/4FL10	1/4	0.110	9/16 Hex	1	0.55	0.71	0.84	1.00	1.22	1.41	1.73	2.0	2.4	125°	130°	134°	137°	148°	156°	
1/4FL12	1/4	0.120	9/16 Hex	1 5/16	0.66	0.85	1.00	1.20	1.47	1.70	2.1	2.4	2.9	110°	115°	122°	130°	141°	150°	
1/4FL15	1/4	0.129	9/16 Hex	1 5/16	0.82	1.06	1.25	1.50	1.84	2.1	2.6	3.0	3.7	90°	98°	109°	125°	136°	144°	
1/4FL18	1/4	0.147	9/16 Hex	1 5/16	0.99	1.27	1.51	1.80	2.2	2.5	3.1	3.6	4.4	104°	113°	118°	124°	134°	138°	
1/4FL20	1/4	0.154	9/16 Hex	1 5/16	1.10	1.41	1.67	2.0	2.4	2.8	3.5	4.0	4.9	110°	119°	127°	131°	136°	144°	
1/4FL22	1/4	0.161	9/16 Hex	1 5/16	1.20	1.56	1.84	2.2	2.7	3.1	3.8	4.4	5.4	97°	108°	114°	120°	128°	132°	
1/4FL24	1/4	0.169	9/16 Hex	1 5/16	1.31	1.70	2.0	2.4	2.9	3.4	4.2	4.8	5.9	106°	118°	121°	127°	136°	154°	
1/4FL27	1/4	0.177	9/16 Hex	1 5/16	1.48	1.91	2.3	2.7	3.3	3.8	4.7	5.4	6.6	110°	120°	124°	129°	139°	146°	
3/8FL30	3/8	0.188	1 1/16 Hex	1 1/2	1.64	2.1	2.5	3.0	3.7	4.2	5.2	6.0	7.3	104°	116°	121°	127°	135°	138°	
3/8FL35	3/8	0.196	1 1/16 Hex	1 1/2	1.92	2.5	2.9	3.5	4.3	4.9	6.1	7.0	8.6	104°	114°	118°	126°	130°	137°	
3/8FL40	3/8	0.209	1 1/16 Hex	1 1/2	2.2	2.8	3.3	4.0	4.9	5.7	6.9	8.0	9.8	109°	115°	123°	126°	135°	136°	
3/8FL45	3/8	0.228	1 1/16 Hex	1 1/2	2.5	3.2	3.8	4.5	5.5	6.4	7.8	9.0	11.0	117°	126°	134°	139°	142°	144°	

MODEL NUMBER	PIPE SIZE NPT	ORIFICE DIA. (inches)	DIMENSIONS		CAPACITY (GPM) AT VARIOUS PRESSURES (psi)										SPRAY ANGLE @					
			A	L	3 psi	5 psi	7 psi	10 psi	15 psi	20 psi	30 psi	40 psi	60 psi	3 psi	5 psi	7 psi	10 psi	20 psi	60 psi	
1/2FL40	1/2	0.209	7/8 Hex	1 11/16	2.2	2.8	3.3	4.0	4.9	5.7	6.9	8.0	9.8	106°	111°	119°	124°	129°	133°	
1/2FL50	1/2	0.242	7/8 Hex	1 11/16	2.7	3.5	4.2	5.0	6.1	7.1	8.7	10.0	12.2	106°	122°	130°	133°	139°	141°	
1/2FL60	1/2	0.266	7/8 Hex	2	3.3	4.2	5.0	6.0	7.3	8.5	10.4	12.0	14.7	110°	120°	124°	128°	133°	138°	
1/2FL70	1/2	0.290	7/8 Hex	2	3.8	4.9	5.9	7.0	8.6	9.9	12.1	14.0	17.1	105°	118°	119°	121°	124°	130°	
1/2FL80	1/2	0.312	7/8 Hex	2	4.4	5.7	6.7	8.0	9.8	11.3	13.9	16.0	19.6	114°	116°	124°	126°	130°	135°	
3/4FL90	3/4	0.316	1 1/16 Hex	2 3/8	4.9	6.4	7.5	9.0	11.0	12.7	15.6	18.0	22	104°	115°	120°	121°	125°	128°	
3/4FL100	3/4	0.344	1 1/16 Hex	2 3/8	5.5	7.1	8.4	10.0	12.2	14.1	17.3	20	24	105°	113°	115°	118°	121°	125°	
3/4FL110	3/4	0.348	1 1/16 Hex	2 3/8	6.0	7.8	9.2	11.0	13.5	15.6	19.1	22	27	106°	110°	116°	119°	120°	121°	
3/4FL120	3/4	0.375	1 1/16 Hex	2 3/8	6.6	8.5	10.0	12.0	14.7	17.0	21	24	29	119°	125°	129°	131°	133°	135°	
3/4FL140	3/4	0.402	1 1/4 Hex	2 5/8	7.7	9.9	11.7	14.0	17.1	19.8	24	28	34	115°	120°	128°	133°	137°	139°	
3/4FL160	3/4	0.430	1 1/4 Hex	2 5/8	8.8	11.3	13.4	16.0	19.6	23	28	32	39	117°	122°	130°	135°	139°	140°	
3/4FL180	3/4	0.460	1 1/2 Hex	2 5/8	9.9	12.7	15.1	18.0	22	25	31	36	44	117°	128°	131°	133°	136°	136°	
3/4FL210	3/4	0.500	1 1/2 Hex	2 5/8	11.5	14.8	17.6	21	26	30	36	42	51	122°	127°	132°	135°	136°	136°	
1FL140	1	0.402	1 1/2 Hex	2 13/16	7.7	9.9	11.7	14.0	17.1	20	24	28	34	117°	122°	126°	130°	133°	133°	
1FL160	1	0.430	1 1/2 Hex	2 13/16	8.8	11.3	13.4	16.0	20	23	28	32	39	117°	127°	131°	135°	136°	136°	
1FL180	1	0.460	1 1/2 Hex	2 13/16	9.9	12.7	15.1	18.0	22	25	31	36	44	115°	125°	128°	132°	135°	135°	
1FL210	1	0.500	1 1/2 Hex	2 13/16	11.5	14.8	17.6	21	26	30	36	42	51	117°	122°	127°	130°	133°	134°	
1FL300	1	0.578	3/4 Hex	3 3/8	16.4	21	25	30	37	42	52	60	73	114°	118°	120°	123°	124°	124°	
1FL450	1	0.704	3/4 Hex	3 3/8	25	32	38	45	55	64	78	90	110	128°	135°	139°	142°	144°	144°	

FLAT SPRAY

FL Series

Flooding nozzles for air and steam applications

SPRAY CHARACTERISTICS:

The FL series spray nozzles may also be used with air or steam, resulting in a deflected curtain of gas extending no more than a few inches away from the nozzle. For most applications, the maximum practical target distance from the nozzle is 10 inches.

CONSTRUCTION:

The models listed are machined from bar stock, and are one piece construction. Standard materials are brass, 303 stainless steel and 316 stainless steel. Some models are also available in other materials, such as PVC, CPVC, Teflon® and polypropylene.

TYPICAL APPLICATIONS:

For dispensing air or steam. Stainless steel construction recommended for steam applications.

- Cleaning
- Cooling
- Blow-off of surfaces

MODEL NUMBER			ORIFICE DIA. (inches)	AIR CAPACITY (SCFM)					STEAM CAPACITY (Lbs/Hr)					COVERAGE AT 6" DISTANCE FROM THE NOZZLE (inches)	
1/8 Pipe Size	1/4 Pipe Size	3/8 Pipe size		10 psi	20 psi	40 psi	50 psi	80 psi	10 psi	20 psi	40 psi	50 psi	80 psi	10 psi	15 psi
1/8FL.25			.017	0.10	0.14	0.22	0.26	0.38	0.27	0.38	0.60	0.71	1.04	2	4 1/2
1/8FL.50			.024	0.19	0.27	0.43	0.50	0.74	0.56	0.79	1.25	1.47	2.2	2	5
1/8FL.75			.029	0.28	0.39	0.61	0.73	1.06	0.83	1.17	1.84	2.2	3.2	2 1/2	6
1/8FL1			.033	0.36	0.51	0.80	0.95	1.39	1.09	1.52	2.4	2.8	4.1	3	6
1/8FL1.3	1/4FL1.3		.038	0.48	0.68	1.07	1.27	1.86	1.46	2.0	3.2	3.7	5.5	3	6 1/2
1/8FL1.5	1/4FL1.5		.042	0.58	0.83	1.31	1.55	2.3	1.79	2.5	3.9	4.7	6.8	3 1/2	6 1/2
1/8FL2	1/4FL2		.047	0.73	1.03	1.62	1.92	2.8	2.3	3.2	5.0	6.0	8.7	3 1/2	7 1/2
1/8FL2.5	1/4FL2.5		.055	1.00	1.42	2.2	2.6	3.9	3.1	4.4	6.9	8.2	12.0	4	7 1/2
1/8FL3	1/4FL3		.059	1.15	1.63	2.6	3.0	4.4	3.6	5.0	7.9	9.3	13.6	5	8
1/8FL4	1/4FL4		.070	1.61	2.3	3.6	4.3	6.3	5.1	7.2	11.3	13.4	19.6	5	9
1/8FL5	1/4FL5		.076	1.90	2.7	4.3	5.0	7.4	6.0	8.5	13.4	15.8	23	6	10
1/8FL7.5	1/4FL7.5		.094	2.91	4.2	6.6	7.8	11.5	9.3	13.1	21	24	36	6 1/2	10
1/8FL10	1/4FL10		.110	3.99	5.7	9.0	10.6	15.6	12.8	17.9	28	33	49	7	11
1/8FL12	1/4FL12		.120	4.7	6.8	10.7	12.7	18.6	15.3	21	33	39	57	7	11 1/2
1/8FL15	1/4FL15		.129	5.5	8.4	13.2	15.7	23	18.8	26	41	48	71	7	12
1/8FL18	1/4FL18		.147	7.1	10.3	16.2	19.2	28	23	32	50	60	87	8	13
1/8FL20	1/4FL20		.154	7.8	11.3	17.8	21	31	25	35	55	65	96	8 1/2	14 1/2
	1/4FL22		.161	8.5	12.3	19.4	23	34	28	39	61	73	106	8 1/2	14 1/2
	1/4FL24		.169	9.4	13.6	21	25	37	31	43	68	80	117	8 1/2	15
	1/4FL27		.177	10.3	14.9	23	28	41	34	47	74	88	128	8 1/2	15
	3/8FL30		.188	11.6	16.8	26	31	46	38	53	84	99	145	8 1/2	15 1/2

High impact flat spray nozzles

FP Series

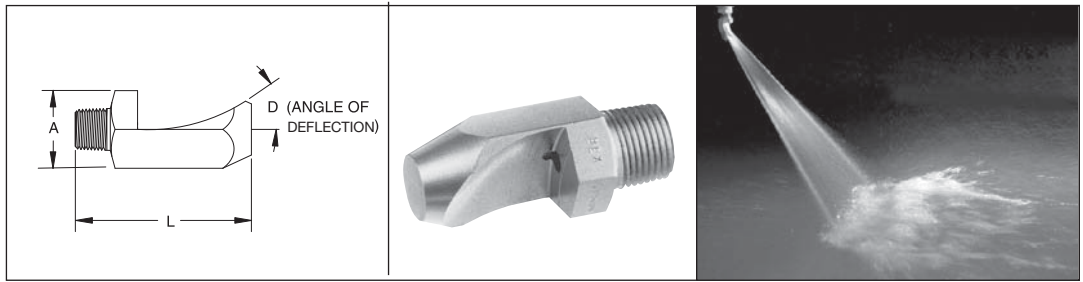

SPRAY CHARACTERISTICS:

A flat and thin fan-shaped spray with sharp definition on all edges. This spray delivers very high impact over the area covered. The spray is deflected by angle D away from the centerline of the spray nozzle.

CONSTRUCTION:

The models listed are machined from bar stock, and are one piece construction. Standard materials are brass, 303 stainless steel and 316 stainless steel.

TYPICAL APPLICATIONS:

- High Impact Applications
- Metal Wash
- Gravel Washing
- Vehicle Washing

SPRAY ANGLE @ 40psi	MODEL NUMBER	PIPE SIZE NPT	ORIFICE DIA. (inches)	ANGLE 'D' @ 40psi	Dimensions (inches)		CAPACITY (GPM) AT VARIOUS PRESSURES (psi)										SPRAY ANGLE @		
					'A'	'L'	15 psi	20 psi	30 psi	40 psi	60 psi	80 psi	100 psi	150 psi	15 psi	40 psi	100 psi		
50°	1/8FP5001	1/8	0.024	40°	1/2 Hex	27/32	0.06	0.07	0.09	0.10	0.12	0.14	0.16	0.19	30°	50°	58°		
	1/4FP50025	1/4	0.038	41°	11/16 Hex	13/64	0.15	0.18	0.22	0.25	0.31	0.35	0.40	0.48	29°	50°	57°		
	1/4FP5005	1/4	0.053	41°	11/16 Hex	11/8	0.31	0.35	0.43	0.50	0.61	0.71	0.79	0.97	30°	50°	59°		
	1/4FP5010	1/4	0.075	52°	11/16 Hex	11/4	0.61	0.71	0.87	1.00	1.22	1.41	1.58	1.94	32°	50°	59°		
	1/4FP5025	1/4	0.118	40°	11/16 Hex	15/16	1.53	1.77	2.2	2.5	3.1	3.5	4.0	4.8	41°	50°	58°		
	3/8FP5025	3/8	0.118	40°	11/16 Hex	13/8	1.53	1.77	2.2	2.5	3.1	3.5	4.0	4.8	41°	50°	58°		
	1/4FP5040	1/4	0.149	45°	7/8 Hex	17/8	2.4	2.8	3.5	4.0	4.9	5.7	6.3	7.7	42°	50°	59°		
	3/8FP5040	3/8	0.149	44°	7/8 Hex	129/32	2.4	2.8	3.5	4.0	4.9	5.7	6.3	7.7	40°	50°	59°		
	3/8FP5060	3/8	0.183	40°	7/8 Hex	23/16	3.7	4.2	5.2	6.0	7.3	8.5	9.5	11.6	41°	50°	52°		
	3/8FP50100	3/8	0.236	38°	11/4 Hex	23/4	6.1	7.1	8.7	10.0	12.2	14.1	15.8	19.4	44°	50°	54°		
	3/8FP50125	3/8	0.266	34°	11/4 Hex	25/6	7.7	8.8	10.8	12.5	15.3	17.7	19.8	24	39°	50°	57°		
	3/8FP50160	3/8	0.298	37°	11/4 Hex	211/16	9.8	11.3	13.9	16.0	19.6	23	25	31	46°	50°	55°		
3/8FP50200	3/8	0.328	33°	13/8 Hex	27/8	12.2	14.1	17.3	20	24	28	32	39	47°	50°	55°			
40°	3/8FP4040	3/8	0.149	34°	7/8 Hex	23/32	2.4	2.8	3.5	4.0	4.9	5.7	6.3	7.7	29°	40°	48°		
	3/8FP4050	3/8	0.167	32°	11/4 Hex	29/16	3.1	3.5	4.3	5.0	6.1	7.1	7.9	9.7	30°	40°	47°		
	3/8FP4060	3/8	0.183	31°	11/8 Hex	227/32	3.7	4.2	5.2	6.0	7.3	8.5	9.5	11.6	31°	40°	50°		
	3/8FP4070	3/8	0.197	28°	11/4 Hex	215/16	4.3	4.9	6.1	7.0	8.6	9.9	11.1	13.6	33°	40°	50°		
	3/8FP4080	3/8	0.211	28°	11/4 Hex	215/16	4.9	5.7	6.9	8.0	9.8	11.3	12.6	15.5	33°	40°	48°		
	3/8FP4090	3/8	0.228	28°	11/4 Hex	215/16	5.5	6.4	7.8	9.0	11.0	12.7	14.2	17.4	34°	40°	46°		
	3/8FP40100	3/8	0.236	31°	11/4 Hex	31/8	6.1	7.1	8.7	10.0	12.2	14.1	15.8	19.4	34°	40°	46°		
	35°	1/8FP3504	1/8	0.047	36°	7/16 Hex	15/16	0.24	0.28	0.35	0.40	0.49	0.57	0.63	0.77	20°	35°	41°	
1/4FP3510		1/4	0.075	37°	11/16 Hex	17/16	0.61	0.71	0.87	1.00	1.22	1.41	1.58	1.94	18°	35°	38°		
1/4FP3520		1/4	0.105	30°	11/16 Hex	19/16	1.22	1.41	1.73	2.0	2.4	2.8	3.2	3.9	25°	35°	42°		
3/8FP3520		3/8	0.105	32°	11/16 Hex	15/8	1.22	1.41	1.73	2.0	2.4	2.8	3.2	3.9	25°	35°	41°		
3/8FP3525		3/8	0.117	29°	11/16 Hex	123/32	1.53	1.77	2.2	2.5	3.1	3.5	4.0	4.8	24°	35°	41°		
3/8FP3530		3/8	0.128	28°	7/8 Hex	21/8	1.84	2.1	2.6	3.0	3.7	4.2	4.7	5.8	25°	35°	42°		
1/4FP3540		1/4	0.149	31°	7/8 Hex	211/32	2.4	2.8	3.5	4.0	4.9	5.7	6.3	7.7	29°	35°	42°		
3/8FP3540		3/8	0.149	31°	7/8 Hex	211/32	2.4	2.8	3.5	4.0	4.9	5.7	6.3	7.7	29°	35°	42°		
3/8FP3550		3/8	0.167	26°	1 Hex	25/8	3.1	3.5	4.3	5.0	6.1	7.1	7.9	9.7	30°	35°	40°		
1/2FP3560		1/2	0.183	29°	11/16 Hex	27/8	3.7	4.2	5.2	6.0	7.3	8.5	9.5	11.6	27°	35°	40°		
1/2FP3580		1/2	0.211	22°	11/4 Hex	35/16	4.9	5.7	6.9	8.0	9.8	11.3	12.6	15.5	25°	35°	38°		
1/2FP35100		1/2	0.221	24°	11/4 Hex	31/2	6.1	7.1	8.7	10.0	12.2	14.1	15.8	19.4	25°	35°	40°		
3/4FP35160	3/4	0.295	22°	11/4 Hex	413/32	9.8	11.3	13.9	16.0	19.6	23	25	31	26°	35°	39°			
3/4FP35200	3/4	0.328	24°	11/4 Hex	411/32	12.2	14.1	17.3	20	24	28	32	39	31°	35°	42°			
25°	1/4FP2540	1/4	0.149	24°	7/8 Hex	21/2	2.4	2.8	3.5	4.0	4.9	5.7	6.3	7.7	22°	25°	27°		
15°	1/4FP1510	1/4	0.075	22°	11/16 Hex	115/16	0.61	0.71	0.87	1.00	1.22	1.41	1.58	1.94	--	15°	21°		
	1/4FP1520	1/4	0.105	16°	11/16 Hex	21/4	1.22	1.41	1.73	2.0	2.4	2.8	3.2	3.9	--	15°	18°		
	3/8FP1530	3/8	0.129	20°	7/8 Hex	227/32	1.84	2.1	2.6	3.0	3.7	4.2	4.7	5.8	8°	15°	24°		
	3/8FP1540	3/8	0.149	13°	7/8 Hex	33/4	2.4	2.8	3.5	4.0	4.9	5.7	6.3	7.7	8°	15°	20°		
	3/8FP1550	3/8	0.167	14°	7/8 Hex	35/8	3.1	3.5	4.3	5.0	6.1	7.1	7.9	9.7	8°	15°	22°		
	1/2FP1560	1/2	0.183	14°	1 Hex	415/16	3.7	4.2	5.2	6.0	7.3	8.5	9.5	11.6	11°	15°	18°		
	1/2FP1580	1/2	0.218	14°	11/8 Hex	51/8	4.9	5.7	6.9	8.0	9.8	11.3	12.6	15.5	11°	15°	18°		
	1/2FP15100	1/2	0.236	15°	11/8 Hex	57/16	6.1	7.1	8.7	10.0	12.2	14.1	15.8	19.4	11°	15°	17°		
	3/4FP15200	3/4	0.333	15°	11/2 Hex	79/16	12.2	14.1	17.3	20	24	28	32	39	11°	15°	17°		
	3/4FP15300	3/4	0.408	15°	13/4 Hex	71/2	18.4	21	26	30	37	42	47	58	12°	15°	18°		

-- means not recommended at this pressure

FLAT SPRAY

S Series

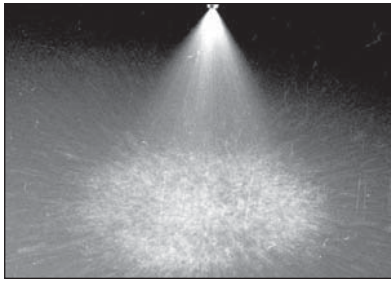

Full cone spray nozzles

SPRAY CHARACTERISTICS:

Full cone spray pattern, with uniform distribution throughout the cone.

CONSTRUCTION:

The nozzle contains a patented insert with larger flow passages than older styles, and is less susceptible to clogging. Standard materials are brass, 303 stainless steel, and 316 stainless steel.

Some models are also stocked in PVC, CPVC, and polypropylene. For molded plastic models, please see page 35.

TYPICAL APPLICATIONS:

- Chemical Processing
- Cooling Sprays
- Foam Breaking
- Continuous Casting

U.S. Patent No. 4,142,682
Canadian Patent No. 1,050,589

S SERIES

One piece body + non-removable insert

DIMENSIONS

NOZZLE SIZE	Dim. A	Dim. L
1/8S	1/16 HEX	13/16
1/4S	3/16 HEX	15/16
3/8S	1/4 HEX	1 1/16
1/2S	3/8 HEX	1 3/16
3/4FS	1/2 HEX	2 1/16
1FS	3/4 HEX	2 3/8
1S	1 1/4 dia.	2 3/4

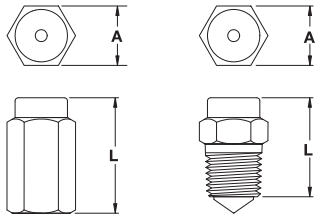

GS SERIES

Two piece body + removable insert

DIMENSIONS

NOZZLE SIZE	Dim. A	Dim. L
1/8GS	5/16 HEX	1 3/16
1/4GS	11/16 HEX	1 1/2
3/8GS	1 1/16 HEX	1 11/16
1/2GS	1 HEX	2
3/4FGS	3/4 HEX	2 1/16
1FGS	1 1/16 HEX	2 3/8
3/4FGS	3/4 HEX	2 3/8
1/2FGS	1 HEX	2 3/8

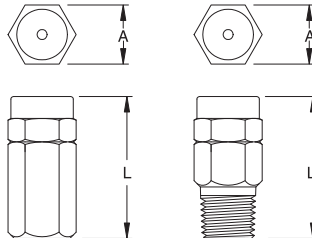

HGS SERIES

Two piece body + removable insert

Sprays at right angle to pipe.

DIMENSIONS

NOZZLE SIZE	Dim. A	Dim. B	Dim. C	Dim. D	Dim. L
1/8HGS	23/32	11/16	5/8 SQ	1 1/32	1
1/4HGS	29/32	1 3/16	1 3/8 SQ	1 9/32	1 3/8
3/8HGS	1 1/32	1 1/4	1 7/8 SQ	1 15/32	1 17/32
1/2HGS	1 1/8	1 3/4	1 SQ	1 11/16	1 7/8
3/4FHGS	23/32	1 1/16	3/4 SQ	1 1/32	1
1/4FHGS	29/32	1 3/16	1 1/8 SQ	1 9/32	1 3/8
3/8FHGS	1 1/32	1 1/8	1 1/4 SQ	1 15/32	1 17/32
1/2FHGS	1 1/8	1 3/8	1 SQ	1 11/16	1 7/8

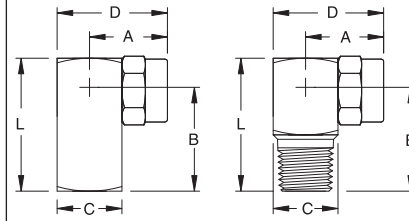

S' one piece body		GS' two piece body		HGS' right angle, two piece body		PIPE SIZE NPT	MAXIMUM FREE PASSAGE (inches)	CAPACITY (GPM) AT VARIOUS PRESSURES (psi)																Spray Angle @		
FEMALE	MALE	FEMALE	MALE	FEMALE	MALE			3 psi	5 psi	7 psi	10 psi	15 psi	20 psi	30 psi	40 psi	60 psi	80 psi	100 psi	150 psi	7 psi	20 psi	80 psi				
1/8S1	1/8FGS1	1/8GS1	1/8FHGS1	1/8HGS1	1/8	0.033	--	--	--	0.12	0.14	0.17	0.20	0.24	0.28	0.32	0.39	--	55°	52°						
1/8S1.5	1/8FGS1.5	1/8GS1.5	1/8FHGS1.5	1/8HGS1.5	1/8	0.046	--	--	0.15	0.18	0.21	0.26	0.30	0.37	0.42	0.47	0.58	--	65°	57°						
1/8S2	1/8FGS2	1/8GS2	1/8FHGS2	1/8HGS2	1/8	0.051	--	0.17	0.20	0.24	0.28	0.35	0.40	0.49	0.57	0.63	0.77	54°	59°	60°						
1/8S3	1/8FGS3	1/8GS3	1/8FHGS3	1/8HGS3	1/8	0.051	--	0.21	0.25	0.30	0.37	0.42	0.52	0.60	0.73	0.85	0.95	1.16	50°	53°	60°					
1/8S3.5	1/8FGS3.5	1/8GS3.5	1/8FHGS3.5	1/8HGS3.5	1/8	0.051	0.19	0.25	0.29	0.35	0.43	0.49	0.61	0.70	0.86	0.99	1.11	1.36	48°	58°	61°					
1/8S5	1/8FGS5	1/8GS5	1/8FHGS5	1/8HGS5	1/8	0.064	0.27	0.35	0.42	0.50	0.61	0.71	0.87	1.00	1.22	1.41	1.58	1.94	60°	75°	70°					
1/8S6	1/8FGS6	1/8GS6	1/8FHGS6	1/8HGS6	1/8	0.064	0.33	0.42	0.50	0.60	0.73	0.85	1.04	1.20	1.47	1.70	1.90	2.3	67°	72°	70°					
1/4S5	1/4FGS5	1/4GS5	1/4FHGS5	1/4HGS5	1/4	0.081	0.27	0.35	0.42	0.50	0.61	0.71	0.87	1.00	1.22	1.41	1.58	1.94	58°	68°	62°					
1/4S6.5	1/4FGS6.5	1/4GS6.5	1/4FHGS6.5	1/4HGS6.5	1/4	0.091	0.36	0.46	0.54	0.65	0.80	0.92	1.13	1.30	1.59	1.84	2.1	2.5	48°	56°	50°					
1/4S7.5	1/4FGS7.5	1/4GS7.5	1/4FHGS7.5	1/4HGS7.5	1/4	0.091	0.41	0.53	0.63	0.75	0.92	1.06	1.30	1.50	1.84	2.1	2.4	2.9	55°	65°	48°					
1/4S8.5	1/4FGS8.5	1/4GS8.5	1/4FHGS8.5	1/4HGS8.5	1/4	0.091	0.47	0.60	0.71	0.85	1.04	1.20	1.47	1.70	2.1	2.4	2.7	3.3	58°	65°	63°					
1/4S10	1/4FGS10	1/4GS10	1/4FHGS10	1/4HGS10	1/4	0.091	0.55	0.71	0.84	1.00	1.22	1.41	1.73	2.0	2.4	2.8	3.2	3.9	60°	65°	62°					
1/4S14	1/4FGS14	1/4GS14	1/4FHGS14	1/4HGS14	1/4	0.091	0.77	0.99	1.17	1.40	1.71	1.98	2.4	2.8	3.4	4.0	4.4	5.4	78°	78°	75°					
3/8S9.5	3/8FGS9.5	3/8GS9.5	3/8FHGS9.5	3/8HGS9.5	3/8	0.102	0.52	0.67	0.79	0.95	1.16	1.34	1.65	1.90	2.3	2.7	3.0	3.7	58°	68°	62°					
3/8S10	3/8FGS10	3/8GS10	3/8FHGS10	3/8HGS10	3/8	0.102	0.55	0.71	0.84	1.00	1.22	1.41	1.73	2.0	2.4	2.8	3.2	3.9	55°	65°	50°					
3/8S15	3/8FGS15	3/8GS15	3/8FHGS15	3/8HGS15	3/8	0.102	0.82	1.06	1.25	1.50	1.84	2.1	2.6	3.0	3.7	4.2	4.7	5.8	63°	65°	60°					
3/8S18	3/8FGS18	3/8GS18	3/8FHGS18	3/8HGS18	3/8	0.102	0.99	1.27	1.51	1.80	2.2	2.5	3.1	3.6	4.4	5.1	5.7	7.0	85°	88°	76°					
3/8S20	3/8FGS20	3/8GS20	3/8FHGS20	3/8HGS20	3/8	0.102	1.10	1.41	1.67	2.0	2.4	2.8	3.5	4.0	4.9	5.7	6.3	7.7	76°	82°	75°					
3/8S22	3/8FGS22	3/8GS22	3/8FHGS22	3/8HGS22	3/8	0.114	1.20	1.56	1.84	2.2	2.7	3.1	3.8	4.4	5.4	6.2	7.0	8.5	76°	78°	76°					
1/2S16	1/2FGS16	1/2GS16	1/2FHGS16	1/2HGS16	1/2	0.144	0.88	1.13	1.34	1.60	1.96	2.3	2.8	3.2	3.9	4.5	5.1	6.2	55°	60°	55°					
1/2S25	1/2FGS25	1/2GS25	1/2FHGS25	1/2HGS25	1/2	0.144	1.37	1.77	2.1	2.5	3.1	3.5	4.3	5.0	6.1	7.1	7.9	9.7	68°	73°	65°					
1/2S32	1/2FGS32	1/2GS32	1/2FHGS32	1/2HGS32	1/2	0.144	1.75	2.3	2.7	3.2	3.9	4.5	5.5	6.4	7.8	9.1	10.1	12.4	80°	90°	75°					
1/2S40	1/2FGS40	1/2GS40	1/2FHGS40	1/2HGS40	1/2	0.162	2.2	2.8	3.3	4.0	4.9	5.7	6.9	8.0	9.8	11.3	12.6	15.5	86°	90°	81°					
3/4FS30	3/4S30				3/4	0.162	1.64	2.1	2.5	3.0	3.7	4.2	5.2	6.0	7.3	8.5	9.5	11.6	50°	52°	49°					
3/4FS50	3/4S50				3/4	0.195	2.7	3.5	4.2	5.0	6.1	7.1	8.7	10.0	12.2	14.1	15.8	19.4	65°	70°	65°					
3/4FS83	3/4S83				3/4	0.195	4.5	5.9	6.9	8.3	10.2	11.7	14.4	16.6	20	23	26	32	93°	97°	86°					
1FS83	1S83				1	0.219	4.5	5.9	6.9	8.3	10.2	11.7	14.4	16.6	20	23	26	32	71°	78°	75°					
1FS106	1S106				1	0.219	5.8	7.5	8.9	10.6	13.0	15.0	18.4	21	26	30	34	41	86°	89°	80°					
1FS120	1S120				1	0.219	6.6	8.5	10.0	12.0	14.7	17.0	21	24	29	34	38	46	80°	94°	85°					
1FS142	1S142				1	0.219	7.8	10.0	11.9	14.2	17.4	20	25	28	35	40	45	55	88°	92°	83°					

FULL CONE

Wide angle spray full cone nozzles

SW Series

SPRAY CHARACTERISTICS:

A wide angle full cone spray pattern, with uniform distribution throughout the cone.

CONSTRUCTION:

This nozzle contains a patented insert with larger flow passages than older styles, and is less susceptible to clogging. Standard materials are brass, 303 stainless steel and 316 stainless steel. Some models are also stocked in PVC,

CPVC and polypropylene.

For molded plastic models, please see page 36.

TYPICAL APPLICATIONS:

Anywhere a wide angle full cone spray is required:

- Chemical Processing
- Cooling Sprays
- Continuous Casting

U.S. Patent No. 4,142,682
Canadian Patent No. 1,050,589

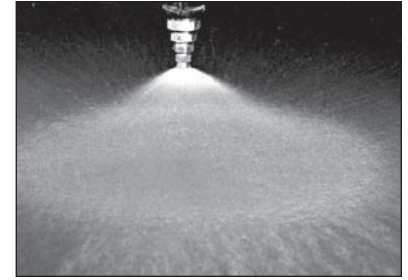

SW SERIES

One piece body + non-removable insert

DIMENSIONS

MALE SW	Dim. A	Dim. L	FEMALE SW	Dim. A	Dim. L
1/8 SW	7/16 HEX	1 1/4	3/4 FSW	1 1/4 HEX	2 1/2
1/4 SW	3/8 HEX	1 1/4	1 FSW	1 1/2 HEX	2 1/2
3/8 SW	1 1/8 HEX	1 1/4	1 1/2 FSW	2 HEX	3 1/2
1/2 SW	7/8 HEX	1 1/4	1 3/4 FSW	2 1/4 Dia.	4 1/4
3/4 SW	1 1/4 HEX	1 1/4	2 FSW	2 3/4 Dia.	5 1/2
1 SW	1 3/4 dia.	2 1/4	2 1/2 FSW	3 1/2 Dia.	6 1/2
			3 FSW	4" Dia.	7 1/2
			4 FSW	5" Dia.	10 1/2

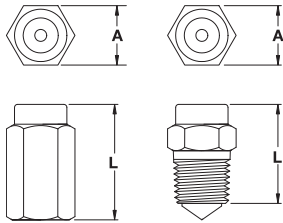

GSW SERIES

Two piece body + removable insert

DIMENSIONS

NOZZLE SIZE	Dim. A	Dim. L
1/8 GSW	5/8 HEX	1 1/2
1/4 GSW	1 1/8 HEX	1 3/4
3/8 GSW	1 1/4 HEX	1 11/16
1/2 GSW	1 HEX	2
3/8 FGSW	5/8 HEX	1 3/4
1/2 FGSW	1 1/8 HEX	1 21/32
3/4 FGSW	1 1/4 HEX	1 15/16
1/2 FGSW	1 HEX	2 1/32

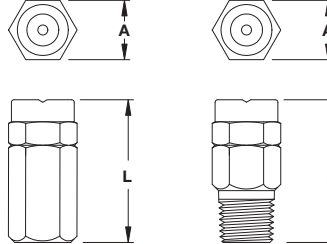

HGSW SERIES

Two piece body + removable insert.

Sprays at right angle to pipe.

DIMENSIONS

NOZZLE SIZE	Dim. A	Dim. B	Dim. C	Dim. D	Dim. L
1/8 HGSW	29/32	1 1/16	5/8 SQ	1 1/32	1
1/4 HGSW	29/32	1	3/4 SQ	1 9/32	1 3/8
3/8 HGSW	1 1/32	1 1/8	7/8 SQ	1 19/32	1 17/32
1/2 HGSW	1 1/8	1 3/8	1 SQ	1 11/16	1 7/8
3/8 FHGSW	2 1/32	1 1/8	5/8 SQ	2 9/32	3 1/32
1/2 FHGSW	2 9/32	1	3/4 SQ	1 9/32	1 9/8
3/4 FHGSW	1 1/32	1 3/8	7/8 SQ	1 19/32	1 17/32
1/2 FHGSW	1 3/8	1 3/8	1 SQ	1 11/16	1 7/8

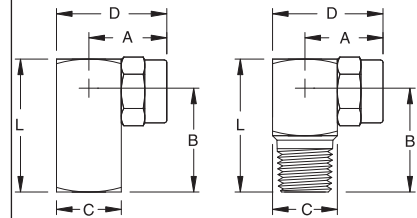

FULL CONE

'SW' one piece body	'GSW' two piece body		'HGSW' right angle, two piece body		PIPE SIZE NPT	MAXIMUM FREE PASSAGE (inches)	CAPACITY (GPM) AT VARIOUS PRESSURES (psi)												Spray Angle @		
	FEMALE	MALE	FEMALE	MALE			5 psi	7 psi	10 psi	15 psi	20 psi	30 psi	40 psi	60 psi	80 psi	100 psi	150 psi	7 psi	20 psi	80 psi	
1/8S2.8W	1/8FGS2.8W	1/8GS2.8W	1/8FHGS2.8W	1/8HGS2.8W	1/8	0.051	--	0.23	0.28	0.34	0.40	0.48	0.56	0.69	0.79	0.89	1.08	1.08	105°	96°	
1/8S4.3W	1/8FGS4.3W	1/8GS4.3W	1/8FHGS4.3W	1/8HGS4.3W	1/8	0.051	--	0.36	0.43	0.53	0.61	0.74	0.86	1.05	1.22	1.36	1.67	117°	108°	100°	
1/8S5.6W	1/8FGS5.6W	1/8GS5.6W	1/8FHGS5.6W	1/8HGS5.6W	1/8	0.064	--	0.47	0.56	0.69	0.79	0.97	1.12	1.37	1.58	1.77	2.2	117°	110°	100°	
1/8S8W	1/8FGS8W	1/8GS8W	1/8FHGS8W	1/8HGS8W	1/8	0.081	0.57	0.67	0.80	0.98	1.13	1.39	1.60	1.96	2.3	2.5	3.1	118°	110°	103°	
1/4S5.6W	1/4FGS5.6W	1/4GS5.6W	1/4FHGS5.6W	1/4HGS5.6W	1/4	0.064	0.40	0.47	0.56	0.69	0.79	0.97	1.12	1.37	1.58	1.77	2.2	120°	108°	102°	
1/4S10W	1/4FGS10W	1/4GS10W	1/4FHGS10W	1/4HGS10W	1/4	0.091	0.71	0.84	1.00	1.22	1.41	1.73	2.0	2.4	2.8	3.2	3.9	118°	108°	102°	
1/4S12W	1/4FGS12W	1/4GS12W	1/4FHGS12W	1/4HGS12W	1/4	0.091	0.85	1.00	1.20	1.47	1.70	2.1	2.4	2.9	3.4	3.8	4.6	120°	112°	102°	
1/4S14W	1/4FGS14W	1/4GS14W	1/4FHGS14W	1/4HGS14W	1/4	0.091	0.99	1.17	1.40	1.71	1.98	2.4	2.8	3.4	4.0	4.4	5.4	118°	114°	104°	
3/8S17W	3/8FGS17W	3/8GS17W	3/8FHGS17W	3/8HGS17W	3/8	0.102	1.20	1.42	1.70	2.1	2.4	2.9	3.4	4.2	4.8	5.4	6.6	118°	117°	102°	
3/8S20W	3/8FGS20W	3/8GS20W	3/8FHGS20W	3/8HGS20W	3/8	0.102	1.41	1.67	2.0	2.4	2.8	3.5	4.0	4.9	5.7	6.3	7.7	120°	120°	106°	
3/8S24W	3/8FGS24W	3/8GS24W	3/8FHGS24W	3/8HGS24W	3/8	0.102	1.70	2.0	2.4	2.9	3.4	4.2	4.8	5.9	6.8	7.6	9.3	122°	118°	106°	
3/8S27W	3/8FGS27W	3/8GS27W	3/8FHGS27W	3/8HGS27W	3/8	0.102	1.91	2.3	2.7	3.3	3.8	4.7	5.4	6.6	7.6	8.5	10.5	122°	120°	107°	
1/2S30W	1/2FGS30W	1/2GS30W	1/2FHGS30W	1/2HGS30W	1/2	0.144	2.1	2.5	3.0	3.7	4.2	5.2	6.0	7.3	8.5	9.5	11.6	120°	118°	110°	
1/2S35W	1/2FGS35W	1/2GS35W	1/2FHGS35W	1/2HGS35W	1/2	0.144	2.5	2.9	3.5	4.3	4.9	6.1	7.0	8.6	9.9	11.1	13.6	122°	118°	108°	
1/2S40W	1/2FGS40W	1/2GS40W	1/2FHGS40W	1/2HGS40W	1/2	0.162	2.8	3.3	4.0	4.9	5.7	6.9	8.0	9.8	11.3	12.6	15.5	122°	119°	104°	
1/2S45W	1/2FGS45W	1/2GS45W	1/2FHGS45W	1/2HGS45W	1/2	0.162	3.2	3.8	4.5	5.5	6.4	7.8	9.0	11.0	12.7	14.2	17.4	141°	118°	108°	
3/4FS50W	3/4FS50W				3/4	0.195	3.5	4.2	5.0	6.1	7.1	8.7	10.0	12.2	14.1	15.8	19.4	120°	120°	110°	
3/4FS71W	3/4FS71W				3/4	0.195	5.0	5.9	7.1	8.7	10.0	12.3	14.2	17.4	20	22	27	118°	120°	112°	
1FS13W	1S13W				1	0.219	9.2	10.9	13.0	15.9	18.4	23	26	32	37	41	50	120°	123°	118°	
1 1/4FS19W					1 1/4	0.26	13.4	15.9	19.0	23	27	33	38	47	54	60	74	122°	123°	120°	
1 1/2FS29W					1 1/2	0.329	21	24	29	36	41	50	58	71	82	92	112	125°	125°	120°	
2FS56W					2	0.438	40	47	56	69	79	97	112	137	158	177	217	125°	125°	118°	
2 1/2FS83W					2 1/2	0.531	59	69	83	102	117	144	166	203	235	262	321	122°	123°	120°	
3FS107W					3	0.688	76	90	107	131	151	185	214	262	303	338	414	125°	123°	123°	
4FS165W					4	0.875	117	138	165	202	233	286	330	404	467	522	639	125°	125°	123°	

SQ Series

Square spray full cone nozzles



SPRAY CHARACTERISTICS:

Full cone spray pattern, with uniform distribution throughout the approximately square cone.

CONSTRUCTION:

Standard materials are brass, 303 and 316 stainless. Larger sizes in cast 316 or 303 stainless bar. Some models are also stocked in plastics and other materials.

TYPICAL APPLICATIONS:

- Chemical Processing
- Cooling Sprays
- Continuous Casting

Please see page 36 for molded plastic models.

SQ SERIES

One piece body + non-removable insert



DIMENSIONS

NOZZLE SIZE	Dim. A	Dim. L
1/8SQ	7/16 HEX	13/16
1/4SQ	9/16 HEX	15/16
3/8SQ	11/16 HEX	1 1/16
1/2SQ	7/8 HEX	1 9/32
3/4SQ	1 1/16 HEX	1 7/8
1FSQ	1 1/8 dia.	2 5/8
1 1/4FSQ	1 7/8 dia.	3 1/2
1 1/2FSQ	2 1/4 dia.	4 1/4
2FSQ	2 3/4 dia.	5 1/8
2 1/2FSQ	3 1/2 dia.	6 7/8

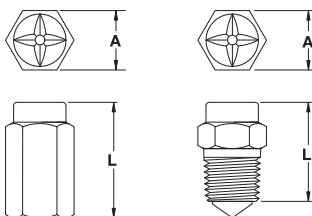

GSQ SERIES

Two piece body + removable insert



DIMENSIONS

NOZZLE SIZE	Dim. A	Dim. L
1/8GSQ	5/8 HEX	1 1/16
1/4GSQ	11/16 HEX	1 9/16
3/8GSQ	13/16 HEX	1 11/16
1/2GSQ	1 HEX	2
1/4FGSQ	5/8 HEX	1 9/32
1/2FGSQ	11/16 HEX	1 21/32
3/4FGSQ	13/16 HEX	1 15/16
1/2FGSQ	1 HEX	2 3/32

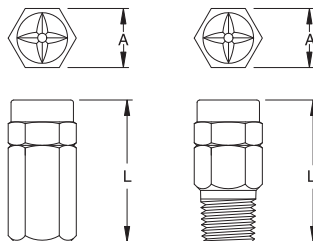

'SQ' one piece body	'GSQ' two piece body		PIPE SIZE NPT	MAXIMUM FREE PASSAGE (inches)	CAPACITY (GPM) AT VARIOUS PRESSURES (psi)															Spray Angle @		
	FEMALE	MALE			5 psi	7 psi	10 psi	15 psi	20 psi	30 psi	40 psi	60 psi	80 psi	100 psi	150 psi	7 psi	20 psi	80 psi				
1/8S3.6SQ	1/8FGS3.6SQ	1/8GS3.6SQ	1/8	0.057	--	0.30	0.36	0.44	0.51	0.62	0.72	0.88	1.02	1.14	1.39	42°	55°	50°				
1/8S4.8SQ	1/8FGS4.8SQ	1/8GS4.8SQ	1/8	0.064	--	0.40	0.48	0.59	0.68	0.83	0.96	1.18	1.36	1.52	1.86	50°	65°	60°				
1/8S6SQ	1/8FGS6SQ	1/8GS6SQ	1/8	0.081	--	0.50	0.60	0.73	0.85	1.04	1.20	1.47	1.70	1.90	2.3	30°	65°	60°				
1/4S6SQ	1/4FGS6SQ	1/4GS6SQ	1/4	0.081	0.42	0.50	0.60	0.73	0.85	1.04	1.20	1.47	1.70	1.90	2.3	60°	65°	60°				
1/4S10SQ	1/4FGS10SQ	1/4GS10SQ	1/4	0.091	0.71	0.84	1.00	1.22	1.41	1.73	2.0	2.4	2.8	3.2	3.9	61°	67°	60°				
1/4S12SQ	1/4FGS12SQ	1/4GS12SQ	1/4	0.091	0.85	1.00	1.20	1.47	1.70	2.1	2.4	2.9	3.4	3.8	4.6	71°	76°	69°				
1/4S14SQ	1/4FGS14SQ	1/4GS14SQ	1/4	0.091	0.99	1.17	1.40	1.71	1.98	2.4	2.8	3.4	4.0	4.4	5.4	78°	85°	75°				
3/8S18SQ	3/8FGS18SQ	3/8GS18SQ	3/8	0.102	1.27	1.51	1.80	2.2	2.5	3.1	3.6	4.4	5.1	5.7	7.0	70°	75°	68°				
1/2S29SQ	1/2FGS29SQ	1/2GS29SQ	1/2	0.144	2.1	2.4	2.9	3.6	4.1	5.0	5.8	7.1	8.2	9.2	11.2	70°	75°	68°				
1/2S36SQ	1/2FGS36SQ	1/2GS36SQ	1/2	0.144	2.5	3.0	3.6	4.4	5.1	6.2	7.2	8.8	10.2	11.4	13.9	80°	85°	77°				
3/4S50SQ			3/4	0.195	3.5	4.2	5.0	6.1	7.1	8.7	10.0	12.2	14.1	15.8	19.4	70°	75°	68°				
1FS106SQ			1	0.219	7.5	8.9	10.6	13.0	15.0	18.4	21	26	30	34	41.1	77°	80°	72°				
1 1/4FS177SQ			1 1/4	0.260	12.5	14.8	17.7	21.7	25.0	30.7	35.4	43.4	50	56	69	77°	80°	72°				
1 1/2FS230SQ			1 1/2	0.392	16.3	19.2	23	28	33	40	46	56	65	73	89	74°	79°	72°				
2FS290SQ			2	0.438	21	24	29	36	41	50	58	71	82	92	112	65°	70°	65°				
2FS360SQ			2	0.438	25	30	36	44	51	62	72	88	102	114	139	70°	75°	70°				
2FS480SQ			2	0.438	34	40	48	59	68	83	96	118	136	152	186	78°	80°	76°				
2 1/2FS590SQ			2 1/2	0.531	42	49	59	72	83	102	118	145	167	187	229	75°	80°	73°				

Wide angle square spray full cone nozzles

SWSQ Series

SPRAY CHARACTERISTICS:

Full cone wide angle spray pattern, with uniform distribution through the approximately square cone.

CONSTRUCTION:

Standard materials are brass, 303 and 316 stainless steel. Some models

are also stocked in other materials. See page 42 for PSWSQ plastic wide angle full square nozzles in larger capacities.

TYPICAL APPLICATIONS:

Same as full square (above) but for applications where a wider angle is required.



FULL CONE

'SWSQ' one piece body		PIPE SIZE NPT	MAXIMUM FREE PASSAGE (inches)	CAPACITY (GPM) AT VARIOUS PRESSURES (psi)												Spray Angle @		
FEMALE	MALE			5 psi	7 psi	10 psi	15 psi	20 psi	30 psi	40 psi	60 psi	80 psi	100 psi	150 psi	7 psi	20 psi	80 psi	
	1/4S14WSQ	1/4	0.091	0.99	1.17	1.40	1.71	1.98	2.4	2.8	3.4	4.0	4.4	5.4	99°	95°	84°	
	3/8S17WSQ	3/8	0.102	1.20	1.42	1.70	2.1	2.4	2.9	3.4	4.2	4.8	5.4	6.6	98°	94°	82°	
	3/8S20WSQ	3/8	0.102	1.41	1.67	2.0	2.4	2.8	3.5	4.0	4.9	5.7	6.3	7.7	102°	102°	86°	
	3/8S24WSQ	3/8	0.102	1.70	2.0	2.4	2.9	3.4	4.2	4.8	5.9	6.8	7.6	9.3	104°	102°	86°	
	3/8S27WSQ	3/8	0.102	1.91	2.3	2.7	3.3	3.8	4.7	5.4	6.6	7.6	8.5	10.5	104°	102°	87°	
	1/2S30WSQ	1/2	0.144	2.1	2.5	3.0	3.7	4.2	5.2	6.0	7.3	8.5	9.5	11.6	100°	96°	85°	
	1/2S35WSQ	1/2	0.144	2.5	2.9	3.5	4.3	4.9	6.1	7.0	8.6	9.9	11.1	13.6	104°	99°	88°	
	1/2S40WSQ	1/2	0.162	2.8	3.3	4.0	4.9	5.7	6.9	8.0	9.8	11.3	12.6	15.5	106°	104°	90°	
	1/2S45WSQ	1/2	0.162	3.2	3.8	4.5	5.5	6.4	7.8	9.0	11.0	12.7	14.2	17.4	106°	104°	94°	
3/4FS50WSQ	3/4S50WSQ	3/4	0.195	3.5	4.2	5.0	6.1	7.1	8.7	10.0	12.2	14.1	15.8	19.4	108°	102°	97°	
3/4FS71WSQ	3/4S71WSQ	3/4	0.195	5.0	5.9	7.1	8.7	10.0	12.3	14.2	17.4	20	22	27	99°	102°	93°	
1FS130WSQ	1S130WSQ	1	0.219	9.2	10.9	13.0	15.9	18.4	22.5	26	32	37	41	50	102°	107°	99°	
1 1/4FS190WSQ		1 1/4	0.260	13.4	15.9	19.0	23	27	33	38	47	54	60	74	104°	105°	102°	
1 1/2FS290WSQ		1 1/2	0.329	21	24	29	36	41	50	58	71	82	92	112	107°	107°	102°	
2FS560WSQ		2	0.438	40	47	56	69	79	97	112	137	158	177	217	107°	107°	99°	
2 1/2FS830WSQ		2 1/2	0.531	59	69	83	102	117	144	166	203	235	262	321	104°	105°	102°	
3FS1070WSQ		3	0.688	76	90	107	131	151	185	214	262	303	338	414	107°	105°	105°	

DIMENSIONS

NOZZLE SIZE	Dim. A	Dim. L
1/4SWSQ	9/16 HEX	15/16
3/8SWSQ	11/16 HEX	1 3/16
1/2SWSQ	7/8 HEX	1 7/16
3/4FSWSQ	1 1/4 HEX	2 3/16
3/4SWSQ	1 1/8 HEX	1 11/16
1FSWSQ	1 1/2 HEX	2 5/8
1SWSQ	1 3/8 HEX	2 1/16
1 1/4FSWSQ	1 7/8 dia.	3 3/4
1 1/2FSWSQ	2 1/4 dia.	4 1/4
2FSWSQ	2 3/4 dia.	5 1/8
2 1/2FSWSQ	3 5/8 dia.	6 1/2
3FSWSQ	4 dia.	7 3/4

30° Full Cone

30° full cone spray nozzles

With a narrow spray angle and a larger droplet size, BEX 30 degree full cone nozzles have more impact per unit area than the wider angle full cone sprays.

Standard connections are NPT threads.

BSPT threads are also available. GS and FGS styles may be disassembled for cleaning. Stock materials are brass, 303 stainless steel and 316 stainless steel.

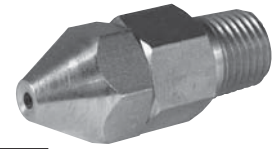

'GS' Style

MODEL NUMBER 'SWSQ' one piece body		PIPE SIZE NPT	MAXIMUM FREE PASSAGE (inches)	Dimensions		CAPACITY (GPM) AT VARIOUS PRESSURES (psi)											Spray Angle @		
FEMALE	MALE			"A" (inches)	"L" (inches)	15 psi	20 psi	30 psi	40 psi	60 psi	80 psi	100 psi	150 psi	200 psi	300 psi	15 psi	40 psi	100 psi	
1/8FGS3001.4	1/8GS3001.4	1/8	0.028	5/8 Hex	1 5/16	0.09	0.10	0.12	0.14	0.17	0.20	0.22	0.27	0.31	0.38	17°	30°	31°	
1/8FGS3002.5	1/8GS3002.5	1/8	0.036	5/8 Hex	1 5/16	0.15	0.18	0.22	0.25	0.31	0.35	0.40	0.48	0.56	0.68	17°	30°	32°	
1/8FGS3004	1/8GS3004	1/8	0.049	5/8 Hex	1 7/16	0.24	0.28	0.35	0.40	0.49	0.57	0.63	0.77	0.89	1.10	26°	30°	32°	
1/8FGS3007	1/8GS3007	1/8	0.057	5/8 Hex	1 7/16	0.43	0.49	0.61	0.70	0.86	0.99	1.11	1.36	1.57	1.92	23°	30°	30°	
1/4FGS3009	1/4GS3009	1/4	0.067	11/16 Hex	1 1/2	0.55	0.64	0.78	0.90	1.10	1.27	1.42	1.74	2.01	2.46	23°	30°	30°	
3/8FGS3014	3/8GS3014	3/8	0.081	13/16 Hex	2 1/8	0.86	0.99	1.21	1.40	1.71	1.98	2.21	2.71	3.13	3.8	26°	30°	31°	
1/2FGS3030	1/2GS3030	1/2	0.114	1" Hex	2 5/8	1.84	2.12	2.60	3.00	3.7	4.2	4.7	5.8	6.7	8.2	31°	30°	31°	
3/4FGS3050	3/4GS3050	3/4	0.162	1 3/8 Hex	3 1/2	3.06	3.5	4.3	5.0	6.1	7.1	7.9	9.7	11.2	13.7	26°	30°	31°	
	1S3070	1	0.193	1 3/8 round	3 5/8	4.3	5.0	6.1	7.0	8.6	9.9	11.1	13.6	16.7	19.2	27°	30°	30°	
	1S30100	1	0.230	1 3/8 round	3 3/8	6.1	7.1	8.7	10.0	12.3	14.1	15.8	19.4	22.4	27.4	27°	30°	30°	
	1 1/2S30150	1 1/4	0.282	1 3/4 round	5	9.2	10.6	13.0	15.0	18.4	21.2	23.7	29.1	33.5	41.1	27°	30°	30°	
	1 1/4S30200	1 1/4	0.326	1 3/4 round	5	12.3	14.1	17.3	20	24.5	28.8	31.6	38.7	44.7	54.8	27°	30°	30°	
	1 1/2S30250	1 1/2	0.360	2" round	6 1/8	15.3	17.7	21.7	25.0	30.6	35	40	48	56	68	27°	30°	30°	
	1 1/2S30300	1 1/2	0.406	2" round	6 1/8	18.4	21.2	26.0	30.0	37	42	47	58	67	82	27°	30°	30°	
	2S30350	2	0.430	2 3/8 round	7 1/8	21.4	24.8	30.3	35	43	50	55	68	78	96	28°	30°	30°	
	2S30400	2	0.461	2 3/8 round	7 1/8	25.5	28.3	35	40	49	57	63	77	89	110	28°	30°	30°	
	2S30500	2	0.500	2 3/8 round	7 1/8	30.6	35	43	50	61	71	79	97	112	137	28°	30°	30°	
	2 1/2S30600	2 1/2	0.560	3" round	10 3/8	37	42	52	60	74	85	95	116	134	164	28°	30°	30°	
	2 1/2S30700	2 1/2	0.600	3" round	10 3/8	43	50	61	70	86	99	111	136	157	192	28°	30°	30°	
	2 1/2S301000	2 1/2	0.730	3" round	10 3/8	61	71	87	100	122	141	158	194	224	274	28°	30°	30°	
	2 1/2S301100	2 1/2	0.760	3" round	10 3/8	67	78	95	110	135	156	174	213	246	301	28°	30°	30°	
	2 1/2S301200	2 1/2	0.800	3" round	10 3/8	73	85	104	120	147	170	190	232	268	328	28°	30°	30°	

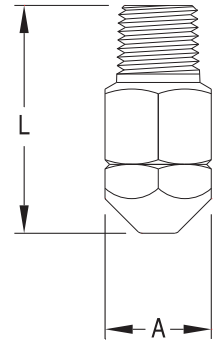

15° Full Cone

15° full cone spray nozzles

With a narrow spray angle and a larger droplet size than other full cone nozzles, BEX 15 degree full cone nozzles have more impact per unit area than wider angle full cone sprays.

Standard connections are NPT threads.

BSPT threads are also available. GS and FGS styles may be disassembled for cleaning. Stock materials are brass, 303 stainless steel and 316 stainless steel.

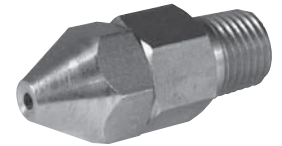

'GS' Style

Model Number		PIPE SIZE NPT	Max. Free Passage (inches)	Dimensions		CAPACITY (GPM) AT VARIOUS PRESSURES (psi)											Spray Angle @		
FEMALE	MALE			"A" (inches)	"L" (inches)	10 psi	20 psi	30 psi	40 psi	60 psi	80 psi	100 psi	150 psi	200 psi	300 psi	10 psi	40 psi	100 psi	
1/8FGS1507	1/8GS1507	1/8	0.028	/ Hex	1 5/16	0.35	0.49	0.61	0.70	0.86	0.99	1.11	1.36	1.57	1.92	13°	15°	15°	
1/8FGS1514	1/8GS1514	1/8	0.036	/ Hex	1 5/8	0.70	0.99	1.21	1.40	1.71	1.98	2.21	2.71	3.3	3.8	13°	15°	15°	
1/4FGS1530	1/4GS1530	1/4	0.049	/ Hex	1 7/16	1.50	2.12	2.60	3.00	3.7	4.2	4.7	5.8	6.7	8.2	13°	15°	15°	
3/8FGS1550	3/8GS1550	3/8	0.057	/ Hex	1 7/16	2.50	3.5	4.3	5.0	6.1	7.1	7.9	9.7	11.2	13.7	13°	15°	15°	
1/2FGS1590	1/2GS1590	1/2	0.067	1" Hex	1 1/2	4.5	6.4	7.8	9.0	11.0	12.7	14.2	17.4	20.1	24.6	13°	15°	15°	
3/4FGS15150	3/4GS15150	3/4	0.081	1 / dia.	2 1/8	7.5	10.6	13.0	15.0	18.4	21.2	22.1	23.7	29.0	34	13°	15°	15°	
	1S15280	1	0.114	1 / dia.	2 5/8	14.0	19.8	24.2	28.0	34	40	44	54	63	77	14°	15°	15°	
	1 1/4S15430	1 1/4	0.162	1 / dia.	3 1/2	21.5	30.4	37	43	53	61	68	83	96	118	14°	15°	15°	
	1 1/2S15630	1 1/2	0.193	2 / dia.	3 3/8	31.5	45	55	63	77	89	100	122	141	173	14°	15°	15°	
	2S151150	2	0.230	3 / dia.	3 3/8	58	81	100	115	141	163	182	223	257	315	14°	15°	15°	
	2 1/2S151750	2 1/2	0.282	3 / dia.	5	88	124	152	175	214	247	277	339	391	479	14°	15°	15°	
	3S152500	3	0.326	4 / dia.	5	125	177	217	250	306	354	395	484	559	685	14°	15°	15°	

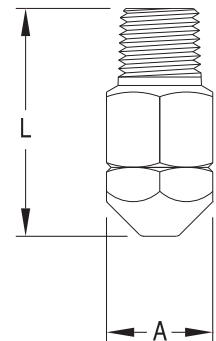

Injection molded full cone nozzles

Molded S Series

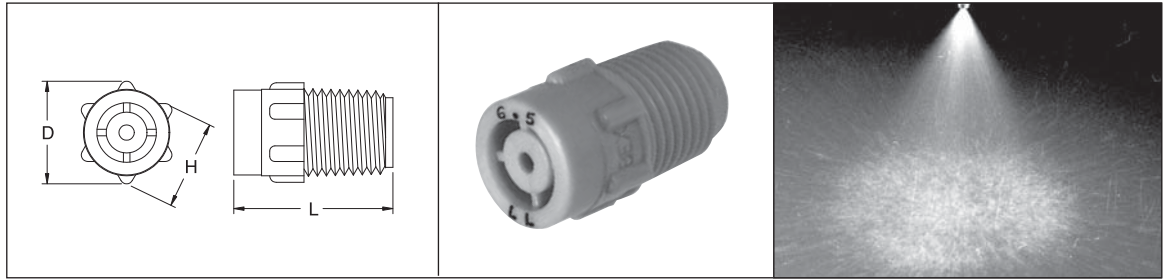

SPRAY CHARACTERISTICS:

These models produce a full cone spray pattern with spray angles of about 60° @ 10 psi.

CONSTRUCTION:

Each BEX molded nozzle is designed with a series of “knobs” which makes them easier to finger tighten than a hex, especially when wet. The design feature of a small starter barrel greatly reduces the tendency to strip or cross-thread the nozzle during installation.

MATERIALS AVAILABLE:

Polypropylene (LL) - excellent chemical and corrosion resistance. Useful up to 175°F.

Natural Polypropylene (LN) - non-pigmented for optimum purity.

PVDF (KK) - excellent durability and abrasion resistance and is inert to most chemicals. Many applications useful up to 300°F.

Natural PVDF (KN) - where solution purity must be optimized.

TYPICAL APPLICATIONS:

- Printed Circuit Board Washing
- PCB-Etching/Developing
- Semiconductor Manufacturing
- Carpet Cleaning
- Fruit and Vegetable Washing
- Plating Processes
- Dust Suppression
- Acid Spraying
- Degreasing
- Coating Applications
- Metal Washing
- Chemical Spraying
- Rinsing Parts

DIMENSIONS

NOZZLE TYPE	Dim. D	Dim. H	Dim. L
1/8 S	0.62	9/16	0.77
1/4 S	0.62	9/16	0.96
3/8 S	0.77	11/16	0.97

FULL CONE

Model Number	PIPE SIZE NPT	MAXIMUM FREE PASSAGE (inches)	CAPACITY AT VARIOUS PRESSURES (USGPM)												SPRAY ANGLE @ (degrees)		
			3 psi	5 psi	7 psi	10 psi	15 psi	20 psi	30 psi	40 psi	60 psi	80 psi	100 psi	150 psi	7 psi	20 psi	80 psi
1/8S1	1/8	0.033	--	--	--	--	0.12	0.14	0.17	0.20	0.25	0.28	0.32	0.39	--	55	52
1/8S1.5	1/8	0.046	--	--	0.13	0.15	0.18	0.21	0.26	0.30	0.37	0.42	0.47	0.58	--	65	57
1/8S3	1/8	0.051	--	0.21	0.25	0.30	0.37	0.42	0.52	0.60	0.73	0.85	0.95	1.16	50	53	60
1/8S5	1/8	0.064	0.27	0.35	0.42	0.50	0.61	0.71	0.87	1.00	1.22	1.41	1.58	1.94	60	75	70
1/8S6	1/8	0.064	0.33	0.42	0.50	0.60	0.73	0.85	1.04	1.20	1.47	1.70	1.90	2.32	67	72	70
1/4S6.5	1/4	0.091	0.36	0.46	0.54	0.65	0.80	0.92	1.13	1.30	1.59	1.84	2.06	2.52	48	56	50
1/4S7.5	1/4	0.091	0.41	0.53	0.63	0.75	0.92	1.06	1.30	1.50	1.84	2.12	2.37	2.90	55	65	48
1/4S10	1/4	0.091	0.55	0.71	0.84	1.00	1.22	1.41	1.73	2.00	2.45	2.83	3.2	3.9	60	65	62
3/8S10	3/8	0.102	0.55	0.71	0.84	1.00	1.22	1.41	1.73	2.00	2.45	2.83	3.2	3.9	55	65	50
3/8S15	3/8	0.102	0.82	1.06	1.25	1.50	1.84	2.12	2.60	3.00	3.7	4.2	4.7	5.8	63	65	60

Molded SW Series

Injection molded full cone wide angle spray nozzles

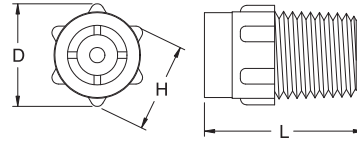
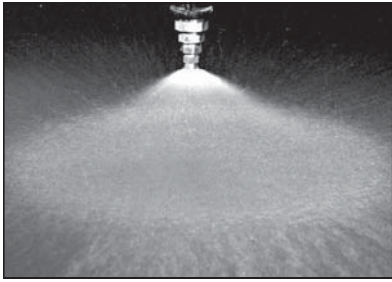

SPRAY CHARACTERISTICS:

These models produce a full cone spray pattern with spray angles of 110° to 120° @ 10 psi.

DIMENSIONS

NOZZLE TYPE	Dim. D	Dim. H	Dim. L
1/8 SW	0.62	9/16	0.77
1/4 SW	0.62	9/16	0.96
3/8 SW	0.77	11/16	0.97

FULL CONE

Model Number	PIPE SIZE NPT	MAXIMUM FREE PASSAGE (inches)	CAPACITY AT VARIOUS PRESSURES (USGPM)											SPRAY ANGLE @ (degrees)		
			5 psi	7 psi	10 psi	15 psi	20 psi	30 psi	40 psi	60 psi	80 psi	100 psi	150 psi	7 psi	20 psi	80 psi
1/8S2.8W	1/8	0.033	--	0.23	0.28	0.34	0.40	0.48	0.56	0.69	0.79	0.89	1.08	110	105	96
1/8S4.3W	1/8	0.046	--	0.36	0.43	0.53	0.61	0.74	0.86	1.05	1.22	1.36	1.67	117	108	100
1/8S5.6W	1/8	0.051	--	0.47	0.56	0.69	0.79	0.97	1.12	1.37	1.58	1.77	2.17	117	110	100
1/4S5.6W	1/4	0.064	--	0.47	0.56	0.69	0.79	0.97	1.12	1.37	1.58	1.77	2.17	120	108	102
1/8S8W	1/8	0.064	0.57	0.67	0.80	0.98	1.13	1.39	1.60	1.96	2.26	2.53	3.10	118	110	103
1/4S10W	1/4	0.091	0.71	0.84	1.00	1.22	1.41	1.73	2.00	2.45	2.83	3.2	3.9	118	108	102
1/4S12W	1/4	0.091	0.85	1.00	1.20	1.47	1.70	2.08	2.40	2.94	3.4	3.8	4.6	120	112	102
1/4S14W	1/4	0.091	0.99	1.17	1.40	1.71	1.98	2.42	2.80	3.4	4.0	4.4	5.4	118	114	104

Molded SQ Series

Injection molded full cone square spray nozzles

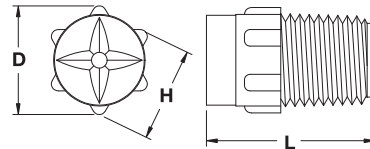
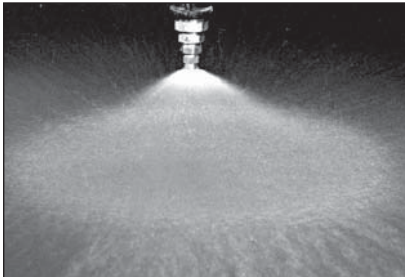

SPRAY CHARACTERISTICS:

These models produce a full cone spray pattern with a spray angle of 60°.

DIMENSIONS

NOZZLE TYPE	Dim. D	Dim. H	Dim. L
1/8 SQ	0.62	9/16	0.77
1/4 SQ	0.62	9/16	0.96

Model Number	PIPE SIZE NPT	MAXIMUM FREE PASSAGE (inches)	CAPACITY AT VARIOUS PRESSURES (USGPM)											SPRAY ANGLE @ (degrees)		
			5 psi	7 psi	10 psi	15 psi	20 psi	30 psi	40 psi	60 psi	80 psi	100 psi	150 psi	7 psi	20 psi	80 psi
1/8S4.8SQ	1/8	0.033	--	0.40	0.48	0.59	0.68	0.83	0.96	1.18	1.36	1.52	1.86	50	65	60
1/8S5SQ	1/8	0.046	--	0.42	0.50	0.61	0.71	0.87	1.00	1.22	1.41	1.58	1.94			
1/4S6SQ	1/4	0.051	--	0.50	0.60	0.73	0.85	1.04	1.20	1.47	1.70	1.90	2.32	60	65	60
1/4S10SQ	1/4	0.064	0.71	0.84	1.00	1.22	1.41	1.73	2.00	2.45	2.83	3.2	3.9	61	67	60
1/4S12SQ	1/4	0.064	0.85	1.00	1.20	1.47	1.70	2.08	2.40	2.94	3.4	3.8	4.6	71	76	69
1/4S14SQ	1/4	0.091	0.99	1.17	1.40	1.71	1.98	2.42	2.80	3.4	4.0	4.4	5.4	78	85	75

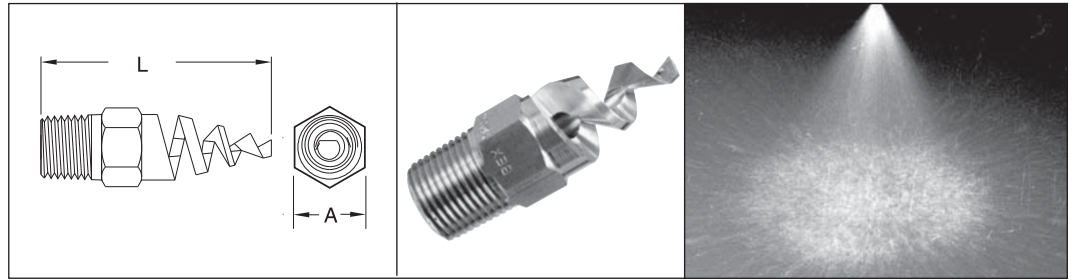

SPRAY CHARACTERISTICS:

A full cone spray pattern with larger flow rates and smaller droplet sizes. Durable, one-piece, anti-clog design has no internal vane to clog or wear out.

CONSTRUCTION:

All models are machined from solid bar stock. Standard materials of construction are brass, 303 stainless steel, 316 stainless steel, PVC and Teflon®. Other materials may be available on request.

TYPICAL APPLICATIONS:

- Washing and Rinsing
- Gas Cooling
- Chemical Processing
- Cooling Sprays
- Humidification

SPRAY ANGLE	MODEL NUMBER	DIMENSIONS		PIPE SIZE (NPT)	ORIFICE DIAMETER (inches)	CAPACITY IN G.P.M. @ VARIOUS PRESSURES (psi)									
		"L"	"A"			5 p.s.i.	7 p.s.i.	10 p.s.i.	20 p.s.i.	30 p.s.i.	40 p.s.i.	60 p.s.i.	100 p.s.i.	200 p.s.i.	300 p.s.i.
60°	1/4YS6007	1.88	9/16	1/4	.087	.49	.59	.70	.99	1.21	1.40	1.71	2.2	3.1	3.8
	1/4YS6013	1.88	9/16	1/4	.119	.92	1.09	1.30	1.84	2.3	2.6	3.2	4.1	5.8	7.1
	3/8YS6007	2.13	11/16	3/8	.087	.49	.59	.70	.99	1.21	1.40	1.71	2.2	3.1	3.8
	3/8YS6013	2.13	11/16	3/8	.119	.92	1.09	1.30	1.84	2.3	2.6	3.2	4.1	5.8	7.1
	3/8YS6020	2.13	11/16	3/8	.147	1.41	1.67	2.0	2.8	3.5	4.0	4.9	6.3	8.9	11.0
	3/8YS6030	2.13	11/16	3/8	.180	2.1	2.5	3.0	4.2	5.2	6.0	7.3	9.5	13.4	16.4
	3/8YS6040	2.13	11/16	3/8	.208	2.8	3.3	4.0	5.7	6.9	8.0	9.8	12.6	17.9	21.9
	3/8YS6053	2.13	11/16	3/8	.239	3.7	4.4	5.3	7.5	9.2	10.6	13.0	16.8	24	29
	3/8YS6082	2.13	11/16	3/8	.298	5.8	6.9	8.2	11.6	14.2	16.4	20	26	37	45
	1/2YS60120	2.50	7/8	1/2	.375	8.5	10	12	17	21	24	29	38	54	66
1/2YS60164	2.50	7/8	1/2	.438	11.6	13.7	16.4	23	28	33	40	52	73	90	
90°	1/4YS9007	1.88	9/16	1/4	.087	.49	.59	.70	.99	1.21	1.40	1.71	2.2	3.1	3.8
	1/4YS9013	1.88	9/16	1/4	.119	.92	1.09	1.30	1.84	2.3	2.6	3.2	4.1	5.8	7.1
	1/4YS9020	1.88	9/16	1/4	.147	1.41	1.67	2.0	2.8	3.5	4.0	4.9	6.3	8.9	11.0
	3/8YS9030	2.13	11/16	3/8	.180	2.1	2.5	3.0	4.2	5.2	6.0	7.3	9.5	13.4	16.4
	3/8YS9040	2.13	11/16	3/8	.208	2.8	3.3	4.0	5.7	6.9	8.0	9.8	12.6	17.9	22
	3/8YS9053	2.13	11/16	3/8	.239	3.7	4.4	5.3	7.5	9.2	10.6	13.0	16.8	24	29
	3/8YS9082	2.13	11/16	3/8	.298	5.8	6.9	8.2	11.6	14.2	16.4	20	26	37	45
	1/2YS90120	2.50	7/8	1/2	.375	8.5	10	12	17	21	24	29	38	54	66
	1/2YS90164	2.50	7/8	1/2	.438	11.6	13.7	16.4	23	28	33	40	52	73	90
	120°	1/4YS12007	1.88	9/16	1/4	.087	.49	.59	.70	.99	1.21	1.40	1.71	2.2	3.1
1/4YS12013		1.88	9/16	1/4	.119	.92	1.09	1.30	1.84	2.3	2.6	3.2	4.1	5.8	7.1
1/4YS12020		1.88	9/16	1/4	.147	1.41	1.67	2.0	2.8	3.5	4.0	4.9	6.3	8.9	11.0
3/8YS12030		2.13	11/16	3/8	.180	2.1	2.5	3.0	4.2	5.2	6.0	7.3	9.5	13.4	16.4
3/8YS12040		2.13	9/16	3/8	.208	2.8	3.3	4.0	5.7	6.9	8.0	9.8	12.6	17.9	22
3/8YS12053		2.13	11/16	3/8	.239	3.7	4.4	5.3	7.5	9.2	10.6	13.0	16.8	24	29
3/8YS12082		2.13	11/16	3/8	.298	5.8	6.9	8.2	11.6	14.2	16.4	20	26	37	45
1/2YS120120		2.50	7/8	1/2	.375	8.5	10	12	17	21	24	29	38	54	66
1/2YS120164		2.50	7/8	1/2	.438	11.6	13.7	16.4	23	28	33	40	52	73	90
150°		1/4YS15013	1.88	9/16	1/4	.119	.92	1.09	1.30	1.84	2.3	2.6	3.2	4.1	5.8
	1/4YS15020	1.88	9/16	1/4	.147	1.41	1.67	2.0	2.8	3.5	4.0	4.9	6.3	8.9	11.0
	3/8YS15030	2.13	11/16	3/8	.180	2.1	2.5	3.0	4.2	5.2	6.0	7.3	9.5	13.4	16.4
	3/8YS15040	2.13	11/16	3/8	.208	2.8	3.3	4.0	5.7	6.9	8.0	9.8	12.6	17.9	22
	3/8YS15053	2.13	11/16	3/8	.239	3.7	4.4	5.3	7.5	9.2	10.6	13.0	16.8	24	29
	3/8YS15082	2.13	11/16	3/8	.298	5.8	6.9	8.2	11.6	14.2	16.4	20	26	37	45
	1/2YS150120	2.50	7/8	1/2	.375	8.5	10	12	17	21	24	29	38	54	66
	1/2YS150164	2.50	7/8	1/2	.438	11.6	13.7	16.4	23	28	33	40	52	73	90

FULL CONE

SPRAY ANGLE	MODEL NUMBER	DIMENSIONS		PIPE SIZE (NPT)	ORIFICE DIAMETER (inches)	CAPACITY IN G.P.M. @ VARIOUS PRESSURES (psi)									
		"L"	"A"			5 p.s.i.	7 p.s.i.	10 p.s.i.	20 p.s.i.	30 p.s.i.	40 p.s.i.	60 p.s.i.	100 p.s.i.	200 p.s.i.	300 p.s.i.
170°	1/4YS17013	1.88	9/16	1/4	.119	.92	1.09	1.30	1.84	2.3	2.6	3.2	4.1	5.8	7.1
	1/4YS17020	1.88	9/16	1/4	.147	1.41	1.67	2.0	2.8	3.5	4.0	4.9	6.3	8.9	11.0
	3/8YS17030	2.13	11/16	3/8	.180	2.1	2.5	3.0	4.2	5.2	6.0	7.3	9.5	13.4	16.4
	3/8YS17040	2.13	11/16	3/8	.208	2.8	3.3	4.0	5.7	6.9	8.0	9.8	12.6	17.9	22
	3/8YS17053	2.13	11/16	3/8	.239	3.7	4.4	5.3	7.5	9.2	10.6	13.0	16.8	24	29
	3/8YS17082	2.13	11/16	3/8	.298	5.8	6.9	8.2	11.6	14.2	16.4	20	26	37	45
	1/2YS170120	2.50	7/8	1/2	.321	8.5	10.0	12.0	17	20	24	29	38	53	66
	1/2YS170164	2.50	7/8	1/2	.375	11.6	13.7	16.4	23	28	33	40	52	73	90
	1/2YS170170	2.50	7/8	1/2	.438	12.0	14.2	17	24	29	34	42	54	76	93

HNS Series

Vaneless full cone nozzles

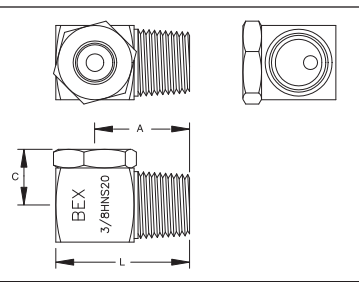
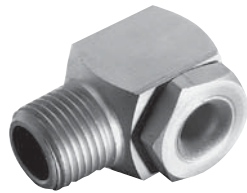
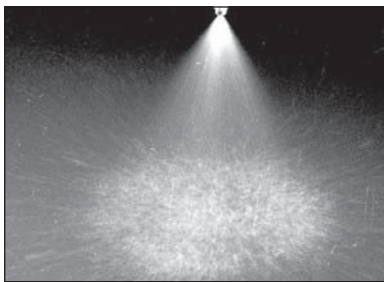

SPRAY CHARACTERISTICS:

The HNS series vaneless full-cone nozzle projects a medium to coarse full-cone spray in a direction perpendicular to the nozzle inlet axis. The maximum free passage in this nozzle is substantially larger than most full-cone nozzles due to the 'vaneless' design. This nozzle is suitable for applications where a relatively coarse full-cone spray is required, and where standard nozzles are subject to plugging.

CONSTRUCTION:

The HNS series are made from bar stock and are a two piece construction. Standard materials are brass, 303 stainless steel and 316 stainless steel. Other materials are available upon request.

TYPICAL APPLICATIONS:

Wherever a medium to coarse full-cone spray is required from a nozzle with a larger maximum free passage.

SPECIAL FEATURES:

- 'Vaneless' full-cone design
- Large maximum free passage
- Easy disassembly/assembly and cleaning

DIMENSIONS

MODEL NUMBER FEMALE	Dim. A	Dim. C	Dim. L	MODEL NUMBER MALE	Dim. A	Dim. C	Dim. L
1/4FHNS	0.94	0.50	1.2	1/4HNS	0.94	0.46	1.2
3/8FHNS	1.0	0.56	1.4	3/8HNS	1.1	0.56	1.5
1/2FHNS	1.4	0.75	1.9	1/2HNS	1.4	0.75	1.9

MODEL NUMBER		PIPE SIZE NPT	MAXIMUM FREE PASSAGE (inches)	CAPACITY (GPM) AT VARIOUS PRESSURES (psi)												Spray Angle (deg.)		
FEMALE	MALE			5 psi	7 psi	10 psi	15 psi	20 psi	30 psi	40 psi	60 psi	80 psi	100 psi	125 psi	10 psi	20 psi	40 psi	
1/4FHNS5	1/4HNS5	1/4	0.078	0.35	0.42	0.50	0.61	0.71	0.87	1.00	1.22	1.41	1.58	1.77	60	75	85	
1/4FHNS7	1/4HNS7	1/4	0.094	0.49	0.59	0.70	0.86	0.99	1.21	1.40	1.71	1.98	2.2	2.5	60	76	90	
1/4FHNS8	1/4HNS8	1/4	0.109	0.57	0.67	0.80	0.98	1.13	1.39	1.60	1.96	2.3	2.5	2.8	63	76	85	
1/4FHNS10	1/4HNS10	1/4	0.125	0.71	0.84	1.00	1.22	1.41	1.73	2.0	2.4	2.8	3.2	3.5	63	79	84	
1/4FHNS11	1/4HNS11	1/4	0.141	0.78	0.92	1.1	1.35	1.56	1.91	2.2	2.7	3.1	3.5	3.9	70	83	86	
3/8FHNS11	3/8HNS11	3/8	0.125	0.78	0.92	1.1	1.35	1.56	1.91	2.2	2.7	3.1	3.5	3.9	80	91	95	
3/8FHNS13	3/8HNS13	3/8	0.141	0.92	1.09	1.3	1.59	1.84	2.3	2.6	3.2	3.7	4.1	4.6	75	81	93	
3/8FHNS16	3/8HNS16	3/8	0.156	1.13	1.34	1.6	1.96	2.3	2.8	3.2	3.9	4.5	5.1	5.7	79	82	86	
3/8FHNS20	3/8HNS20	3/8	0.172	1.41	1.67	2.0	2.4	2.8	3.5	4.0	4.9	5.7	6.3	7.1	77	80	87	
3/8FHNS23	3/8HNS23	3/8	0.188	1.63	1.92	2.3	2.8	3.3	4.0	4.6	5.6	6.5	7.3	8.1	79	70	91	
3/8FHNS26	3/8HNS26	3/8	0.203	1.84	2.2	2.6	3.2	3.7	4.5	5.2	6.4	7.4	8.2	9.2	82	86	93	
3/8FHNS29	3/8HNS29	3/8	0.219	2.1	2.4	2.9	3.6	4.1	5.0	5.8	7.1	8.2	9.2	10.3	86	90	96	
3/8FHNS33	3/8HNS33	3/8	0.234	2.3	2.8	3.3	4.0	4.7	5.7	6.6	8.1	9.3	10.4	11.7	87	90	95	
1/2FHNS32	1/2HNS32	1/2	0.203	2.3	2.7	3.2	3.9	4.5	5.5	6.4	7.8	9.1	10.1	11.3	70	87	94	
1/2FHNS40	1/2HNS40	1/2	0.234	2.8	3.3	4.0	4.9	5.7	6.9	8.0	9.8	11.3	12.6	14.1	84	90	96	
1/2FHNS48	1/2HNS48	1/2	0.281	3.4	4.0	4.8	5.9	6.8	8.3	9.6	11.8	13.6	15.2	17.0	87	93	96	
1/2FHNS56	1/2HNS56	1/2	0.297	4.0	4.7	5.6	6.9	7.9	9.7	11.2	13.7	15.8	17.7	19.8	91	94	96	
1/2FHNS64	1/2HNS64	1/2	0.328	4.5	5.4	6.4	7.8	9.1	11.1	12.8	15.7	18.1	20	23	86	90	94	
1/2FHNS72	1/2HNS72	1/2	0.359	5.1	6.0	7.2	8.8	10.2	12.5	14.4	17.6	20	23	25	89	93	96	

Full cone spray nozzles

CCS Series

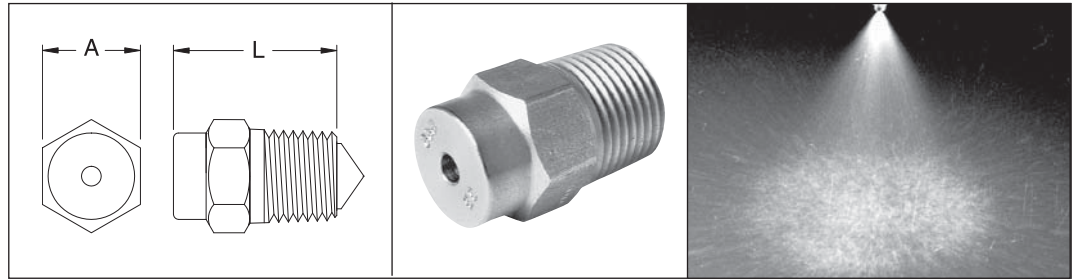

SPRAY CHARACTERISTICS:

Full cone spray pattern with a distribution that is heavier in the middle. Spray angle remains nearly constant at pressures between 20 and 80 p.s.i.

TYPICAL APPLICATIONS:

Suitable for temperature control applications, where the volume of sprayed coolant can be adjusted without significantly affecting spray coverage. This enables the user to maximize heat transfer efficiency while avoiding loss of coverage area. CCS nozzles feature an internal insert which will not come loose in environments which are subject to thermal cycling.

- Continuous Casting and Billet Casting
- Rinsing and Cooling
- Heat Exchanger Cooling
- Chemical Processing

CONSTRUCTION:

CCS nozzles are machined from bar, and consist of a one piece body, plus a non-removable insert. Standard material is brass.

DIMENSIONS

MODEL NUMBER	Dim. A	Dim. L
1/4 CCS	9/16 HEX	15/16
3/8 CCS	11/16 HEX	1 3/16

SPRAY ANGLE @ 40psi	MODEL NUMBER	PIPE SIZE NPT	MAXIMUM FREE PASSAGE (inches)	CAPACITY (GPM) AT VARIOUS PRESSURES (psi)										
				15 psi	20 psi	25 psi	30 psi	40 psi	50 psi	60 psi	70 psi	80 psi	90 psi	100 psi
49°	1/4 CCS4917	1/4	0.091	1.04	1.20	1.34	1.47	1.70	1.90	2.1	2.2	2.4	2.6	2.7
	3/8 CCS4917	3/8	0.091	1.04	1.20	1.34	1.47	1.70	1.90	2.1	2.2	2.4	2.6	2.7
	3/8 CCS4922	3/8	0.091	1.35	1.56	1.74	1.91	2.2	2.5	2.7	2.9	3.1	3.3	3.5
	3/8 CCS4927	3/8	0.102	1.65	1.91	2.1	2.3	2.7	3.0	3.3	3.6	3.8	4.1	4.3
	3/8 CCS4931	3/8	0.114	1.90	2.2	2.5	2.7	3.1	3.5	3.8	4.1	4.4	4.7	4.9
57°	1/4 CCS5710	1/4	0.064	0.61	0.71	0.79	0.87	1.00	1.12	1.22	1.32	1.41	1.50	1.58
	1/4 CCS5713	1/4	0.081	0.80	0.92	1.03	1.13	1.30	1.45	1.59	1.72	1.84	2.0	2.1
	1/4 CCS5715	1/4	0.091	0.92	1.06	1.19	1.30	1.50	1.68	1.84	2.0	2.1	2.3	2.4
	1/4 CCS5718	1/4	0.091	1.10	1.27	1.42	1.56	1.80	2.0	2.2	2.4	2.5	2.7	2.8
	3/8 CCS5718	3/8	0.091	1.10	1.27	1.42	1.56	1.80	2.0	2.2	2.4	2.5	2.7	2.8
	3/8 CCS5726	3/8	0.091	1.59	1.84	2.1	2.3	2.6	2.9	3.2	3.4	3.7	3.9	4.1
	3/8 CCS5731	3/8	0.102	1.9	2.2	2.5	2.7	3.1	3.5	3.8	4.1	4.4	4.7	4.9
	3/8 CCS5744	3/8	0.114	2.7	3.1	3.5	3.8	4.4	4.9	5.4	5.8	6.2	6.6	7.0
66°	1/4 CCS6614	1/4	0.064	0.86	0.99	1.11	1.21	1.40	1.57	1.71	1.85	2.0	2.1	2.2
	1/4 CCS6624	1/4	0.091	1.47	1.70	1.90	2.1	2.4	2.7	2.9	3.2	3.4	3.6	3.8
	1/4 CCS6629	1/4	0.091	1.78	2.1	2.3	2.5	2.9	3.2	3.6	3.8	4.1	4.4	4.6
	3/8 CCS6629	3/8	0.091	1.78	2.1	2.3	2.5	2.9	3.2	3.6	3.8	4.1	4.4	4.6
	3/8 CCS6633	3/8	0.091	2.0	2.3	2.6	2.9	3.3	3.7	4.0	4.4	4.7	5.0	5.2
	3/8 CCS6648	3/8	0.114	2.9	3.4	3.8	4.2	4.8	5.4	5.9	6.3	6.8	7.2	7.6
	3/8 CCS6648	3/8	0.114	2.9	3.4	3.8	4.2	4.8	5.4	5.9	6.3	6.8	7.2	7.6
76°	1/4 CCS7622	1/4	0.091	1.35	1.56	1.74	1.91	2.2	2.5	2.7	2.9	3.1	3.3	3.5
	1/4 CCS7628	1/4	0.091	1.71	2.0	2.2	2.4	2.8	3.1	3.4	3.7	4.0	4.2	4.4
	3/8 CCS7628	3/8	0.091	1.71	2.0	2.2	2.4	2.8	3.1	3.4	3.7	4.0	4.2	4.4
	3/8 CCS7638	3/8	0.091	2.3	2.7	3.0	3.3	3.8	4.2	4.7	5.0	5.4	5.7	6.0
	3/8 CCS7664	3/8	0.114	3.9	4.5	5.1	5.5	6.4	7.2	7.8	8.5	9.1	9.6	10.1
86°	1/4 CCS8618	1/4	0.091	1.10	1.27	1.42	1.56	1.80	2.0	2.2	2.4	2.5	2.7	2.8
	1/4 CCS8633	1/4	0.091	2.0	2.3	2.6	2.9	3.3	3.7	4.0	4.4	4.7	5.0	5.2
	3/8 CCS8633	3/8	0.091	2.0	2.3	2.6	2.9	3.3	3.7	4.0	4.4	4.7	5.0	5.2
	3/8 CCS8642	3/8	0.091	2.6	3.0	3.3	3.6	4.2	4.7	5.1	5.6	5.9	6.3	6.6
	3/8 CCS8649	3/8	0.102	3.0	3.5	3.9	4.2	4.9	5.5	6.0	6.5	6.9	7.4	7.7
	3/8 CCS8667	3/8	0.114	4.1	4.7	5.3	5.8	6.7	7.5	8.2	8.9	9.5	10.1	10.6
	3/8 CCS8667	3/8	0.114	4.1	4.7	5.3	5.8	6.7	7.5	8.2	8.9	9.5	10.1	10.6

FULL CONE

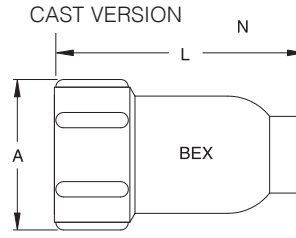
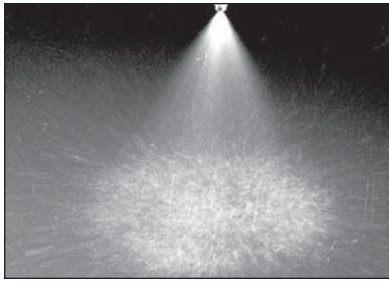

DIMENSIONS

NOZZLE SIZE	Dim. A	Dim. L
1 ¹ / ₄ FS	1 ¹ / ₈	3 ¹ / ₂
1 ¹ / ₂ FS	2 ¹ / ₄	4 ¹ / ₄
2FS	2 ³ / ₄	5 ⁷ / ₁₆
2 ¹ / ₂ FS	3 ³ / ₈	7
3FS	4" Dia.	7 ³ / ₄
4FS	5" Dia.	9 ⁷ / ₈

SPRAY CHARACTERISTICS:

Full cone spray pattern, with uniform distribution throughout the cone.

TYPICAL APPLICATIONS:

- Chemical Processing
- Cooling Sprays
- Foam Breaking
- Heat Exchanger Cooling
- Coke Quenching
- Absorption Stack Spraying
- Gravel Washing

CONSTRUCTION:

All models have a female NPT connection, and consist of a one piece body plus an internal insert. Standard materials are machined 316 stainless steel or cast 316 stainless steel.

MACHINED VERSION

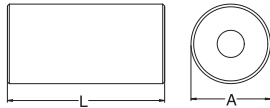

3" and 4" machined from bar.

FULL CONE

'FS' FEMALE	PIPE SIZE NPT	MAXIMUM FREE PASSAGE (inches)	CAPACITY (GPM) AT VARIOUS PRESSURES (psi)													SPRAY ANGLE @		
			3 psi	5 psi	7 psi	10 psi	15 psi	20 psi	30 psi	40 psi	60 psi	80 psi	100 psi	150 psi	7 psi	20 psi	80 psi	
1 ¹ / ₄ FS7.1	1 ¹ / ₄	0.260	3.9	5.0	5.9	7.1	8.7	10.0	12.3	14.2	17.4	20	22	27	54°	56°	50°	
1 ¹ / ₄ FS12	1 ¹ / ₄	0.260	6.6	8.5	10.0	12.0	14.7	17.0	21	24	29	34	38	46	72°	76°	70°	
1 ¹ / ₄ FS14.1	1 ¹ / ₄	0.260	7.7	10.0	11.8	14.1	17.3	19.9	24	28	35	40	45	55	76°	80°	74°	
1 ¹ / ₄ FS16.5	1 ¹ / ₄	0.305	9.0	11.7	13.8	16.5	20	23	29	33	40	47	52	64	85°	90°	83°	
1 ¹ / ₄ FS23.8	1 ¹ / ₄	0.312	13.1	17.0	20	24	29	34	42	48	59	68	76	93	94°	98°	89°	
1 ¹ / ₂ FS12.5	1 ¹ / ₂	0.315	6.8	8.8	10.5	12.5	15.3	17.7	22	25	31	35	40	48	50°	51°	49°	
1 ¹ / ₂ FS19	1 ¹ / ₂	0.329	10.4	13.4	15.9	19.0	23	27	33	38	47	54	60	74	68°	70°	62°	
1 ¹ / ₂ FS24	1 ¹ / ₂	0.329	13.1	17.0	20	24	29	34	42	48	59	68	76	93	82°	88°	70°	
1 ¹ / ₂ FS36	1 ¹ / ₂	0.375	19.7	25	30	36	44	51	62	72	88	102	114	139	98°	103°	85°	
2FS20	2	0.438	11.0	14.1	16.7	20	24	28	35	40	49	57	63	77	50°	64°	60°	
2FS36	2	0.438	19.7	25	30	36	44	51	62	72	88	102	114	139	70°	75°	68°	
2FS42	2	0.438	23	30	35	42	51	59	73	84	103	119	133	163	74°	78°	70°	
2FS47	2	0.438	26	33	39	47	58	66	81	94	115	133	149	182	78°	80°	84°	
2FS7.1	2	0.438	32	42	49	59	72	83	102	118	145	167	187	229	82°	86°	78°	
2FS71	2	0.438	39	50	59	71	87	100	123	142	174	201	225	275	98°	100°	93°	
2 ¹ / ₂ FS30	2 ¹ / ₂	0.438	16	21	25	30	37	42	52	60	73	85	95	116	55°	59°	55°	
2 ¹ / ₂ FS59	2 ¹ / ₂	0.438	32	42	49	59	72	83	102	118	145	167	187	229	75°	80°	72°	
2 ¹ / ₂ FS71	2 ¹ / ₂	0.531	39	50	59	71	87	100	123	142	174	201	225	275	80°	85°	77°	
2 ¹ / ₂ FS83	2 ¹ / ₂	0.531	45	59	69	83	102	117	144	166	203	235	262	321	80°	82°	76°	
2 ¹ / ₂ FS95	2 ¹ / ₂	0.531	52	67	79	95	116	134	165	190	233	269	300	368	86°	90°	82°	
2 ¹ / ₂ FS108	2 ¹ / ₂	0.688	59	76	90	108	132	153	187	216	265	305	342	418	96°	98°	86°	
3FS50	3	0.688	27	35	42	50	61	71	87	100	122	141	158	194	49°	50°	46°	
3FS95	3	0.688	52	67	79	95	116	134	165	190	233	269	300	368	81°	84°	76°	
3FS108	3	0.688	59	76	90	108	132	153	187	216	265	305	342	418	86°	89°	81°	
3FS119	3	0.688	65	84	100	119	146	168	206	238	291	337	376	461	92°	95°	87°	
3FS142	3	0.688	78	100	119	142	174	201	246	284	348	402	449	550	102°	105°	93°	
4FS189	4	0.875	104	134	158	189	231	267	327	378	463	535	598	732	87°	90°	85°	
4FS212	4	0.875	116	150	177	212	260	300	367	424	519	600	670	821	92°	95°	87°	
4FS238	4	0.875	130	168	199	238	291	337	412	476	583	673	753	922	97°	100°	91°	
4FS250	4	0.875	137	177	209	250	306	354	433	500	612	707	791	968	102°	105°	95°	

Plastic full cone spray nozzles

PS & PSW Series

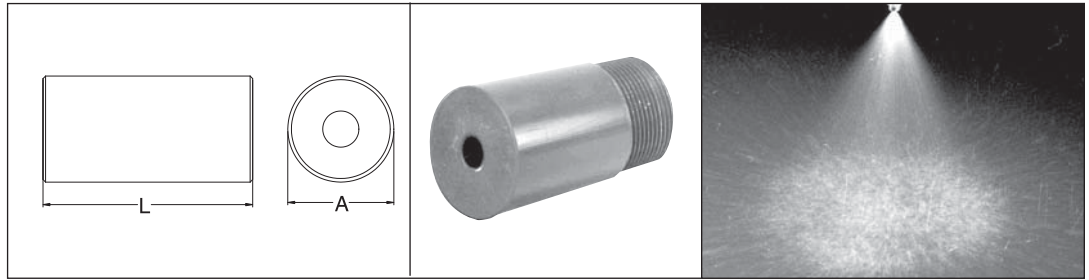

SPRAY CHARACTERISTICS:

A full cone spray pattern with large flow capacities. Spray angle is 90° (included angle). Other sizes and spray angles available upon request.

CONSTRUCTION:

The models listed are machined from plastic and consist of a body plus a non-removable insert. Standard materials are PVC, CPVC, Teflon, and polypropylene.

TYPICAL APPLICATIONS:

- Scrubbing and Pollution Control
- Rinsing and Cooling

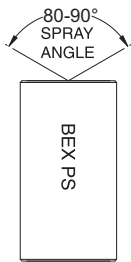

MODEL NUMBER		PIPE SIZE NPT	MAXIMUM FREE PASSAGE (inches)	CAPACITY (GPM) AT VARIOUS PRESSURES (psi)									
FEMALE	MALE			3 psi	5 psi	7 psi	10 psi	20 psi	40 psi	60 psi	80 psi	100 psi	
1 ¹ / ₄ FPS17	1 ¹ / ₄ PS17	1 ¹ / ₄	1 ¹ / ₄	9.3	12.0	14.2	17.0	24	34	42	48	54	
1 ¹ / ₄ FPS20	1 ¹ / ₄ PS20	1 ¹ / ₄	1 ¹ / ₄	11.0	14.1	16.7	20	28	40	49	57	63	
1 ¹ / ₂ FPS17	1 ¹ / ₂ PS17	1 ¹ / ₂	1 ¹ / ₄	9.3	12.0	14.2	17.0	24	34	42	48	54	
1 ¹ / ₂ FPS19	1 ¹ / ₂ PS19	1 ¹ / ₂	1 ¹ / ₄	10.4	13.4	15.9	19.0	27	38	47	54	60	
1 ¹ / ₂ FPS21	1 ¹ / ₂ PS21	1 ¹ / ₂	1 ¹ / ₄	11.5	14.8	17.6	21	30	42	51	59	66	
1 ¹ / ₂ FPS25	1 ¹ / ₂ PS25	1 ¹ / ₂	5 ⁵ / ₁₆	13.7	17.7	21	25	35	50	61	71	79	
1 ¹ / ₂ FPS29	1 ¹ / ₂ PS29	1 ¹ / ₂	5 ⁵ / ₁₆	15.9	21	24	29	41	58	71	82	92	
2FPS20	2PS20	2	1 ¹ / ₄	11.0	14.1	16.7	20	28	40	49	57	63	
2FPS25	2PS25	2	5 ⁵ / ₁₆	13.7	17.7	21	25	35	50	61	71	79	
2FPS32	2PS32	2	5 ⁵ / ₁₆	17.5	23	27	32	45	64	78	91	101	
2FPS40	2PS40	2	3 ³ / ₈	22	28	33	40	57	80	98	113	126	
2FPS48	2PS48	2	3 ³ / ₈	26	34	40	48	68	96	118	136	152	
2FPS55	2PS55	2	17 ¹⁷ / ₃₂	30	39	46	55	78	110	135	156	174	
2FPS60	2PS60	2	17 ¹⁷ / ₃₂	33	42	50	60	85	120	147	170	190	
2FPS72	2PS72	2	9 ⁹ / ₁₆	39	51	60	72	102	144	176	204	228	
2FPS76	2PS76	2	9 ⁹ / ₁₆	42	54	64	76	107	152	186	215	240	
2FPS84	2PS84	2	5 ⁵ / ₈	46	59	70	84	119	168	206	238	266	
2 ¹ / ₂ FPS84	2 ¹ / ₂ PS84	2 ¹ / ₂	5 ⁵ / ₈	46	59	70	84	119	168	206	238	266	
2 ¹ / ₂ FPS96	2 ¹ / ₂ PS96	2 ¹ / ₂	11 ¹¹ / ₁₆	53	68	80	96	136	192	235	272	304	
2 ¹ / ₂ FPS108	2 ¹ / ₂ PS108	2 ¹ / ₂	11 ¹¹ / ₁₆	59	76	90	108	153	216	265	305	342	
3FPS70	3PS70	3	9 ⁹ / ₁₆	38	49	59	70	99	140	171	198	221	
3FPS100	3PS100	3	11 ¹¹ / ₁₆	55	71	84	100	141	200	245	283	316	
3FPS115	3PS115	3	11 ¹¹ / ₁₆	63	81	96	115	163	230	282	325	364	
3FPS140	3PS140	3	13 ¹³ / ₁₆	77	99	117	140	198	280	343	396	443	

DIMENSIONS

FEMALE FPS	Dim. L	Dim. A	MALE PS	Dim. L	Dim. A
1 ¹ / ₄ FPS	3 ³ / ₄	2	1 ¹ / ₄ PS	3	1 ³ / ₄
1 ¹ / ₂ FPS	4 ¹ / ₄	2 ¹ / ₂	1 ¹ / ₂ PS	4	2
2FPS	5 ⁷ / ₈	3	2PS	5 ⁵ / ₈	2 ¹ / ₂
2 ¹ / ₂ FPS	5 ⁷ / ₈	3 ¹ / ₂	2 ¹ / ₂ PS	5 ⁵ / ₈	4
3FPS	5 ⁷ / ₈	4	3PS	5 ¹ / ₂	3 ¹ / ₂

Plastic wide angle full cone spray nozzles

SPRAY CHARACTERISTICS:

A full cone spray pattern with large flow capacities. Similar to the PS series above, but with a wider spray angle of 120° (included angle). Other sizes and spray angles available upon request.

CONSTRUCTION:

The models listed are machined from plastic and consist of a body plus a non-removable

insert. Standard materials are PVC, CPVC, Teflon, and polypropylene.

DIMENSIONS:

Same as PS series (above).

TYPICAL APPLICATIONS:

Same as PS series, but where a wider spray coverage is required.

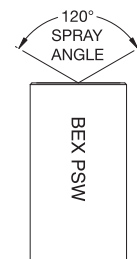

SAME CAPACITIES AS PS SERIES (above). ADD "W" AT THE END OF THE MODEL NUMBER FOR WIDE ANGLE WHEN ORDERING (IE: 2FPS40W).

FULL CONE

PSQ & PSWSQ Series

Plastic full square spray nozzles

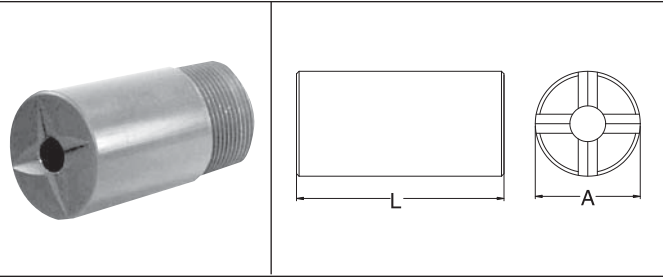
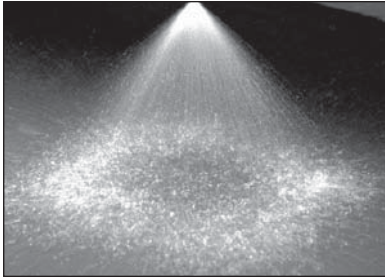

TYPICAL APPLICATIONS:

- Scrubbing and Pollution Control
- Rinsing and Cooling

SPRAY CHARACTERISTICS:

A full square spray pattern with large flow capacities. Spray angle is 90° (included angle). Other sizes and angles available upon request.

CONSTRUCTION:

The models listed are machined from plastic and consist of a body plus a non-removable insert. Standard materials are PVC, CPVC and polypropylene.

FULL CONE

MODEL NUMBER		PIPE SIZE NPT	MAXIMUM FREE PASSAGE (inches)	CAPACITY (GPM) AT VARIOUS PRESSURES (psi)									
FEMALE	MALE			3 psi	5 psi	7 psi	10 psi	20 psi	40 psi	60 psi	80 psi	100 psi	
1 1/4 FPS17SQ	1 1/4 PS17SQ	1 1/4	1/4	9.3	12.0	14.2	17.0	24	34	42	48	54	
1 1/4 FPS20SQ	1 1/4 PS20SQ	1 1/4	1/4	11.0	14.1	16.7	20	28	40	49	57	63	
1 1/2 FPS17SQ	1 1/2 PS17SQ	1 1/2	1/4	9.3	12.0	14.2	17.0	24	34	42	48	54	
1 1/2 FPS19SQ	1 1/2 PS19SQ	1 1/2	1/4	10.4	13.4	15.9	19.0	27	38	47	54	60	
1 1/2 FPS21SQ	1 1/2 PS21SQ	1 1/2	1/4	11.5	14.8	17.6	21	30	42	51	59	66	
1 1/2 FPS25SQ	1 1/2 PS25SQ	1 1/2	5/16	13.7	17.7	21	25	35	50	61	71	79	
1 1/2 FPS29SQ	1 1/2 PS29SQ	1 1/2	5/16	15.9	21	24	29	41	58	71	82	92	
2 FPS20SQ	2 PS20SQ	2	1/4	11.0	14.1	16.7	20	28	40	49	57	63	
2 FPS25SQ	2 PS25SQ	2	5/16	13.7	17.7	21	25	35	50	61	71	79	
2 FPS32SQ	2 PS32SQ	2	5/16	17.5	23	27	32	45	64	78	91	101	
2 FPS40SQF	2 PS40SQ	2	3/8	22	28	33	40	57	80	98	113	126	
2 PS48SQ	2 PS48SQ	2	3/8	26	34	40	48	68	96	118	136	152	
2 FPS55SQ	2 PS55SQ	2	17/32	30	39	46	55	78	110	135	156	174	
2 FPS60SQ	2 PS60SQ	2	17/32	33	42	50	60	85	120	147	170	190	
2 FPS72SQ	2 PS72SQ	2	9/16	39	51	60	72	102	144	176	204	228	
2 FPS76SQ	2 PS76SQ	2	9/16	42	54	64	76	107	152	186	215	240	
2 FPS84SQ	2 PS84SQ	2	5/8	46	59	70	84	119	168	206	238	266	
2 1/2 FPS84SQ	2 1/2 PS84SQ	2 1/2	5/8	46	59	70	84	119	168	206	238	266	
2 1/2 FPS96SQ	2 1/2 PS96SQ	2 1/2	11/16	53	68	80	96	136	192	235	272	304	
2 1/2 FPS108SQ	2 1/2 PS108SQ	2 1/2	11/16	59	76	90	108	153	216	265	305	342	
3 FPS70SQ	3 PS70SQ	3	9/16	38	49	59	70	99	140	171	198	221	
3 FPS100SQ	3 PS100SQ	3	11/16	55	71	84	100	141	200	245	283	316	
3 FPS115SQ	3 PS115SQ	3	11/16	63	81	96	115	163	230	282	325	364	
3 FPS140SQ	3 PS140SQ	3	13/16	77	99	117	140	198	280	343	396	443	

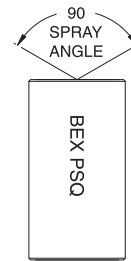

DIMENSIONS

FEMALE FPSQ	Dim. L	Dim. A	MALE PSQ	Dim. L	Dim. A
1 1/4 FPS	3 1/4	2	1 1/4 PS	3	1 3/4
1 1/2 FPS	4 1/4	2 1/2	1 1/2 PS	4	2
2 FPS	5 7/8	3	2 PS	5 5/8	2 1/2
2 1/2 FPS	5 7/8	3 1/2	2 1/2 PS	5 5/8	4
3 FPS	5 7/8	4	3 PS	5 1/2	3 1/2

Plastic wide angle full square spray nozzles

SPRAY CHARACTERISTICS:

A full square spray pattern with large flow capacities. Similar to the PSQ series above, except with a wider spray angle of 120° (included angle). Other sizes and spray angles available upon request.

insert. Standard materials are PVC, CPVC and polypropylene.

DIMENSIONS:

Same as PSQ series (above).

TYPICAL APPLICATIONS:

Same as PSQ series, but where a wider spray coverage is required.

CONSTRUCTION:

The models listed are machined from plastic and consist of a body plus a non-removable

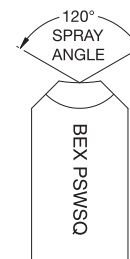

SAME CAPACITIES AS PSQ SERIES (above). ADD "WSQ" AT THE END OF THE MODEL NUMBER FOR WIDE ANGLE WHEN ORDERING (IE: 2FPS40WSQ).

Hollow cone spray nozzles

H Series

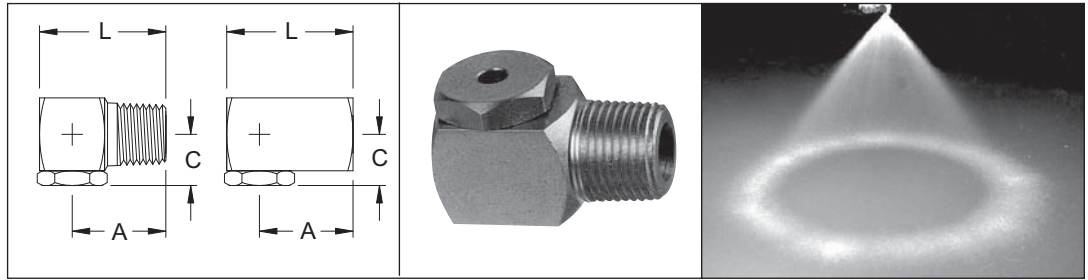

SPRAY CHARACTERISTICS:

A hollow cone spray pattern, emerging at right angles to the centerline of the pipe connection. The standard included angle of the spray cone is 70° at 10 p.s.i. At low pressures hollow cone nozzles produce medium size, uniform droplets. At higher pressures finer droplets are produced.

CONSTRUCTION:

The models listed are machined from bar stock, and are two piece construction. Standard

materials are brass, 303 stainless steel and 316 stainless steel. Some models available in other materials.

TYPICAL APPLICATIONS:

- Air and Gas Washing
- Aerating, Rinsing and Humidifying
- Industrial Washers and Spray Ponds
- Cooling Tunnels
- Roof Cooling
- Degreasing
- Dust Suppression
- Metal Treatment

DIMENSIONS

MALE MODEL	Dim. A	Dim. C	Dim. L	FEMALE MODEL	Dim. A	Dim. C	Dim. L
1/8H	11/16	3/8	1	1/8FH	11/16	3/8	1
1/4H	15/16	1/2	1 1/4	1/4FH	15/16	1/2	1 1/4
3/8H	1	9/16	1 3/8	3/8FH	1	9/16	1 1/2
1/2H	1 3/8	3/4	1 7/8	1/2FH	1 3/8	3/4	1 7/8
3/4H	1 9/16	7/8	2 1/4	3/4FH	1 5/8	7/8	2 1/4

MODEL NUMBER		PIPE SIZE NPT	MAXIMUM FREE PASSAGE (inches)	CAPACITY (GPM) AT VARIOUS PRESSURES (psi)											SPRAY ANGLE @			
FEMALE	MALE			3 psi	5 psi	7 psi	10 psi	15 psi	20 psi	30 psi	40 psi	60 psi	80 psi	100 psi	10 psi	20 psi	40 psi	80 psi
1/8FH0.5	1/8H0.5	1/8	0.028	--	--	--	--	--	--	0.09	0.10	0.12	0.14	0.16	--	--	40°	45°
1/8FH1	1/8H1	1/8	0.053	--	--	--	--	0.12	0.14	0.17	0.20	0.24	0.28	0.32	--	60°	74°	75°
1/8FH2	1/8H2	1/8	0.086	--	--	--	--	0.24	0.28	0.35	0.40	0.49	0.57	0.63	--	65°	72°	76°
1/8FH3	1/8H3	1/8	0.098	--	--	0.25	0.30	0.37	0.42	0.52	0.60	0.73	0.85	0.95	65°	76°	80°	83°
1/8FH5	1/8H5	1/8	0.128	--	0.35	0.42	0.50	0.61	0.71	0.87	1.00	1.22	1.41	1.58	70°	77°	80°	81°
1/8FH7.5	1/8H7.5	1/8	0.153	0.41	0.53	0.63	0.75	0.92	1.06	1.30	1.50	1.84	2.1	2.4	70°	86°	94°	94°
1/8FH10	1/8H10	1/8	0.171	0.55	0.71	0.84	1.00	1.22	1.41	1.73	2.0	2.4	2.8	3.2	70°	71°	73°	75°
1/4FH1	1/4H1	1/4	0.060	--	--	0.08	0.10	0.12	0.14	0.17	0.20	0.24	0.28	0.32	--	61°	74°	69°
1/4FH2	1/4H2	1/4	0.085	--	--	--	0.20	0.24	0.28	0.35	0.40	0.49	0.57	0.63	70°	75°	83°	85°
1/4FH3	1/4H3	1/4	0.111	--	--	0.25	0.30	0.37	0.42	0.52	0.60	0.73	0.85	0.95	70°	70°	72°	74°
1/4FH5	1/4H5	1/4	0.136	--	0.35	0.42	0.50	0.61	0.71	0.87	1.00	1.22	1.41	1.58	70°	77°	80°	83°
1/4FH7.5	1/4H7.5	1/4	0.166	0.41	0.53	0.63	0.75	0.92	1.06	1.30	1.50	1.84	2.1	2.4	70°	70°	74°	75°
1/4FH10	1/4H10	1/4	0.170	0.55	0.71	0.84	1.00	1.22	1.41	1.73	2.0	2.4	2.8	3.2	70°	74°	76°	80°
1/4FH12.5	1/4H12.5	1/4	0.177	0.68	0.88	1.05	1.25	1.53	1.77	2.17	2.5	3.1	3.5	4.0	70°	82°	83°	83°
1/4FH15	1/4H15	1/4	0.213	0.82	1.06	1.25	1.50	1.84	2.1	2.60	3.0	3.7	4.2	4.7	70°	75°	75°	75°
3/8FH5	3/8H5	3/8	0.136	--	0.35	0.42	0.50	0.61	0.71	0.87	1.00	1.22	1.41	1.58	70°	74°	76°	76°
3/8FH7.5	3/8H7.5	3/8	0.164	0.41	0.53	0.63	0.75	0.92	1.06	1.30	1.50	1.84	2.1	2.4	70°	74°	78°	82°
3/8FH10	3/8H10	3/8	0.194	0.55	0.71	0.84	1.00	1.22	1.41	1.73	2.0	2.4	2.8	3.2	70°	78°	80°	81°
3/8FH12.5	3/8H12.5	3/8	0.205	0.68	0.88	1.05	1.25	1.53	1.77	2.17	2.5	3.1	3.5	4.0	70°	80°	82°	84°
3/8FH15	3/8H15	3/8	0.232	0.82	1.06	1.25	1.50	1.84	2.1	2.60	3.0	3.7	4.2	4.7	70°	73°	75°	75°
3/8FH20	3/8H20	3/8	0.250	1.10	1.41	1.67	2.0	2.45	2.8	3.46	4.0	4.9	5.7	6.3	70°	73°	75°	75°
3/8FH25	3/8H25	3/8	0.279	1.37	1.77	2.1	2.5	3.06	3.5	4.33	5.0	6.1	7.1	7.9	70°	72°	73°	73°
3/8FH30	3/8H30	3/8	0.292	1.64	2.1	2.5	3.0	3.67	4.2	5.20	6.0	7.3	8.5	9.5	70°	70°	73°	72°
1/2FH25	1/2H25	1/2	0.295	1.37	1.77	2.1	2.5	3.06	3.5	4.33	5.0	6.1	7.1	7.9	70°	75°	76°	76°
1/2FH30	1/2H30	1/2	0.329	1.64	2.1	2.5	3.0	3.67	4.2	5.20	6.0	7.3	8.5	9.5	70°	78°	80°	81°
1/2FH40	1/2H40	1/2	0.369	2.2	2.8	3.3	4.0	4.90	5.7	6.93	8.0	9.8	11.3	12.6	70°	75°	75°	75°
1/2FH50	1/2H50	1/2	0.393	2.7	3.5	4.2	5.0	6.12	7.1	8.66	10.0	12.2	14.1	15.8	70°	70°	71°	73°
1/2FH60	1/2H60	1/2	0.421	3.3	4.2	5.0	6.0	7.35	8.5	10.39	12.0	14.7	17.0	19.0	70°	70°	71°	71°
3/4FH40	3/4H40	3/4	0.368	2.2	2.8	3.3	4.0	4.90	5.7	6.93	8.0	9.8	11.3	12.6	70°	71°	76°	79°
3/4FH50	3/4H50	3/4	0.421	2.7	3.5	4.2	5.0	6.12	7.1	8.66	10.0	12.2	14.1	15.8	70°	73°	74°	74°
3/4FH60	3/4H60	3/4	0.438	3.3	4.2	5.0	6.0	7.35	8.5	10.39	12.0	14.7	17.0	19.0	70°	75°	78°	80°
3/4FH70	3/4H70	3/4	0.469	3.8	4.9	5.9	7.0	8.57	9.9	12.12	14.0	17.1	19.8	22.1	70°	74°	76°	76°
3/4FH80	3/4H80	3/4	0.484	4.4	5.7	6.7	8.0	9.80	11.3	13.86	16.0	19.6	23	25	70°	73°	75°	76°
3/4FH90	3/4H90	3/4	0.500	4.9	6.4	7.5	9.0	11.02	12.7	15.59	18.0	22	25	28	70°	70°	71°	73°
3/4FH100	3/4H100	3/4	0.507	5.5	7.1	8.4	10.0	12.25	14.1	17.32	20	24	28	32	70°	73°	76°	78°
3/4FH110	3/4H110	3/4	0.575	6.0	7.8	9.2	11.0	13.47	15.6	19.05	22	27	31	35	70°	72°	75°	72°
3/4FH120	3/4H120	3/4	0.568	6.6	8.5	10.0	12.0	14.70	17.0	20.78	24	29	34	38	70°	70°	71°	71°

'--' means not recommended at this pressure

FULL CONE

HW Series

Wide angle hollow cone spray nozzles

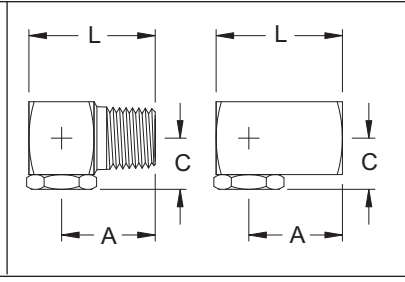
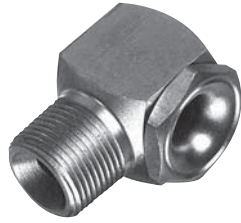
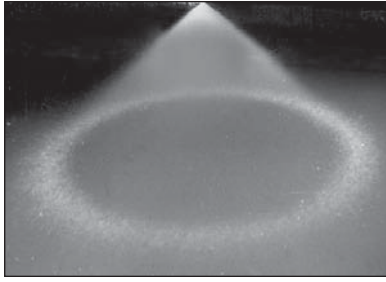

TYPICAL APPLICATIONS:

- Water Cooling
- Roof Cooling
- Air Cooling
- Air Washing

DIMENSIONS

MALE MODEL	Dim. A	Dim. L	Dim. C	FEMALE MODEL	Dim. A	Dim. L	Dim. C
1/8HW	11/16	3/8	1	1/8FHW	11/16	3/8	1
1/4HW	15/16	1/2	1 1/4	1/4FHW	15/16	1/2	1 1/4
3/8HW	1	9/16	1 3/8	3/8FHW	1	9/16	1 3/8
1/2HW	1 3/8	3/4	1 7/8	1/2FHW	1 3/8	3/4	1 7/8
3/4HW	1 9/16	7/8	2 1/4	3/4FHW	1 5/8	7/8	2 1/4

SPRAY CHARACTERISTICS:

A hollow cone spray pattern, similar to the BEX H series, but with wider spray angles. The included angle of the spray cone is 120° at 10 p.s.i.

CONSTRUCTION:

The models listed are machined from bar stock, and are two piece construction. Standard materials are brass, 303 stainless steel and 316 stainless steel. Some models are also available in other materials.

HOLLOW CONE

MODEL NUMBER		PIPE SIZE NPT	MAXIMUM FREE PASSAGE (inches)	CAPACITY (GPM) AT VARIOUS PRESSURES (psi)												SPRAY ANGLE @			
FEMALE	MALE			5 psi	7 psi	10 psi	15 psi	20 psi	30 psi	40 psi	60 psi	80 psi	100 psi	125 psi	10 psi	20 psi	40 psi	80 psi	
1/8FH1W	1/8H1W	1/8	.055	--	--	--	0.12	0.14	0.17	0.20	0.24	0.28	0.32	0.35	--	115°	107°	95°	
1/8FH2W	1/8H2W	1/8	.077	--	0.17	0.20	0.24	0.28	0.35	0.40	0.49	0.57	0.63	0.71	120°	117°	105°	97°	
1/8FH3W	1/8H3W	1/8	.093	--	0.25	0.30	0.37	0.42	0.52	0.60	0.73	0.85	0.95	1.06	120°	116°	109°	92°	
1/8FH5W	1/8H5W	1/8	.109	--	0.42	0.50	0.61	0.71	0.87	1.00	1.22	1.41	1.58	1.77	120°	116°	107°	90°	
1/4FH1W	1/4H1W	1/4	.055	--	0.08	0.10	0.12	0.14	0.17	0.20	0.24	0.28	0.32	0.35	120°	110°	102°	90°	
1/4FH2W	1/4H2W	1/4	.077	--	0.17	0.20	0.24	0.28	0.35	0.40	0.49	0.57	0.63	0.71	120°	110°	105°	92°	
1/4FH3W	1/4H3W	1/4	.093	--	0.25	0.30	0.37	0.42	0.52	0.60	0.73	0.85	0.95	1.06	120°	114°	104°	90°	
1/4FH5W	1/4H5W	1/4	.109	--	0.42	0.50	0.61	0.71	0.87	1.00	1.22	1.41	1.58	1.77	120°	113°	107°	98°	
1/4FH7.5W	1/4H7.5W	1/4	.158	0.53	0.63	0.75	0.92	1.06	1.30	1.50	1.8	2.1	2.4	2.7	120°	115°	110°	92°	
1/4FH10W	1/4H10W	1/4	.170	0.71	0.84	1.00	1.22	1.41	1.73	2.0	2.4	2.8	3.2	3.5	120°	115°	110°	93°	
1/4FH12.5W	1/4H12.5W	1/4	.188	0.88	1.05	1.25	1.53	1.77	2.2	2.5	3.1	3.5	4.0	4.4	120°	118°	110°	94°	
1/4FH15W	1/4H15W	1/4	.201	1.06	1.25	1.50	1.84	2.1	2.6	3.0	3.7	4.2	4.7	5.3	120°	115°	108°	92°	
3/8FH5W	3/8H5W	3/8	.109	0.35	0.42	0.50	0.61	0.71	0.87	1.00	1.22	1.41	1.58	1.77	120°	117°	107°	99°	
3/8FH7.5W	3/8H7.5W	3/8	.158	0.53	0.63	0.75	0.92	1.06	1.30	1.50	1.84	2.1	2.4	2.7	120°	113°	110°	93°	
3/8FH10W	3/8H10W	3/8	.170	0.71	0.84	1.00	1.22	1.41	1.73	2.0	2.4	2.8	3.2	3.5	120°	115°	110°	93°	
3/8FH12.5W	3/8H12.5W	3/8	.188	0.88	1.05	1.25	1.53	1.77	2.2	2.5	3.1	3.5	4.0	4.4	120°	115°	108°	94°	
3/8FH15W	3/8H15W	3/8	.201	1.06	1.25	1.50	1.84	2.1	2.6	3.0	3.7	4.2	4.7	5.3	120°	110°	105°	90°	
3/8FH20W	3/8H20W	3/8	.234	1.41	1.67	2.0	2.4	2.8	3.5	4.0	4.9	5.7	6.3	7.1	120°	118°	116°	110°	
3/8FH25W	3/8H25W	3/8	.265	1.77	2.1	2.5	3.1	3.5	4.3	5.0	6.1	7.1	7.9	8.8	120°	117°	115°	110°	
3/8FH30W	3/8H30W	3/8	.280	2.1	2.5	3.0	3.7	4.2	5.2	6.0	7.3	8.5	9.5	10.6	120°	115°	110°	102°	
1/2FH50W	1/2H50W	1/2	.358	3.5	4.2	5.0	6.1	7.1	8.7	10.0	12.2	14.1	15.8	17.7	120°	115°	108°	103°	
3/4FH80W	3/4H80W	3/4	.468	5.7	6.7	8.0	9.8	11.3	13.9	16.0	20	23	25	28	120°	117°	110°	103°	

PH Series

Hollow cone phosphating nozzles

SPRAY CHARACTERISTICS:

A hollow cone spray pattern for phosphating applications. This large droplet, low impingement type of spray results in a tighter and more consistent phosphate crystalline structure.

CONSTRUCTION:

Two piece construction. Available in 303 stainless steel and 316 stainless steel.

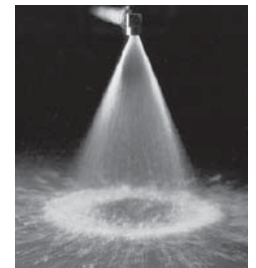
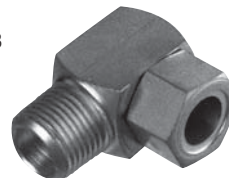

MODEL NUMBER	PIPE SIZE NPT	ORIFICE DIAMETER (inches)		CAPACITY (GPM) AT VARIOUS PRESSURES (psi)												SPRAY ANGLE @		
		BODY	CAP	5 psi	7 psi	10 psi	15 psi	20 psi	30 psi	40 psi	60 psi	80 psi	100 psi	10 psi	15 psi	30 psi		
3/8PH23	3/8	0.220	0.312	1.63	1.92	2.3	2.8	3.3	4.0	4.6	5.6	6.5	7.3	45°	53°	60°		
3/8PH28	3/8	0.231	0.312	2.0	2.3	2.8	3.4	4.0	4.8	5.6	6.9	7.9	8.9	40°	43°	48°		
3/8PH51	3/8	0.344	0.375	3.5	4.2	5.0	6.1	7.1	8.7	10.0	12.2	14.1	15.8	40°	50°	50°		
3/8PH53	3/8	0.375	0.375	3.5	4.2	5.0	6.1	7.1	8.7	10.0	12.2	14.1	15.8	70°	70°	70°		

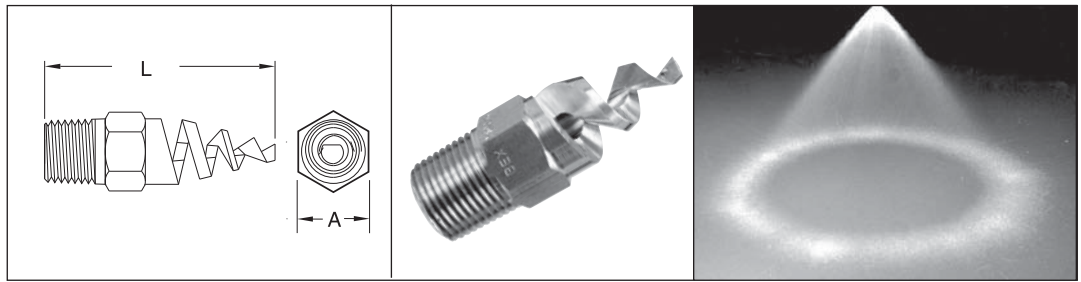

SPRAY CHARACTERISTICS:

A hollow cone spray pattern with large flow rates and small droplet sizes.

CONSTRUCTION:

YH Series nozzles have an anti-clog design that can be easily inspected, cleaned and serviced. Standard materials are brass, 303 stainless steel, 316 stainless steel, PVC and Teflon®. Other materials available upon request.

TYPICAL APPLICATIONS:

- Air & Gas Washing
- Dust Suppression
- Spray Ponds
- Cooling Tunnels
- Medical Treatment
- Humidification

Spray Angle	MODEL NUMBER	Pipe Size (NPT)	Orifice Dia. (inches)	Dimensions		CAPACITY (GPM) AT VARIOUS PRESSURES (psi)													
				"A" (inches)	"L" (inches)	5 psi	7 psi	10 psi	15 psi	20 psi	30 psi	40 psi	60 psi	100 psi	150 psi	200 psi	250 psi	300 psi	
50°	1/4YH5007	1/4	0.094	9/16 Hex	13/16	0.49	0.59	0.70	0.86	0.99	1.21	1.40	1.71	2.21	2.71	3.13	3.5	3.8	
	1/4YH5013	1/4	0.125	9/16 Hex	13/16	0.92	1.09	1.30	1.59	1.84	2.25	2.60	3.2	4.1	5.0	5.8	6.5	7.1	
	1/4YH5020	1/4	0.156	9/16 Hex	13/16	1.41	1.67	2.00	2.45	2.83	3.5	4.0	4.9	6.3	7.7	8.9	10	11	
	3/8YH5030	3/8	0.188	11/16 Hex	21/8	2.12	2.51	3.00	3.7	4.2	5.2	6.0	7.3	9.5	11.6	13.4	15	16	
	3/8YH5040	3/8	0.219	11/16 Hex	21/8	2.83	3.3	4.0	4.9	5.7	6.9	8.0	9.8	12.6	15	18	20	22	
	3/8YH5053	3/8	0.250	11/16 Hex	21/8	3.7	4.4	5.3	6.5	7.5	9.2	10.6	13.0	17	21	24	27	29	
	3/8YH5082	3/8	0.313	11/16 Hex	21/8	5.8	6.9	8.2	10.0	11.6	14.2	16.4	20.1	25.9	32	37	41	45	
	1/2YH50120	1/2	0.375	7/8 Hex	21/2	8.5	10.0	12.0	14.7	17.0	20.8	24.0	29.4	38	46	54	60	66	
	1/2YH50164	1/2	0.438	7/8 Hex	21/2	11.6	13.7	16.4	20.1	23.2	28.4	33	40	52	64	73	82	90	
	3/4YH50210	3/4	0.500	1 1/16 Hex	27/8	14.8	17.6	21.0	25.7	29.7	36	42	51	66	81	94	105	115	
	60°	1/4YH6007	1/4	0.094	9/16 Hex	13/16	0.49	0.59	0.70	0.86	0.99	1.21	1.40	1.71	2.21	2.71	3.13	3.5	3.8
		1/4YH6013	1/4	0.125	9/16 Hex	13/16	0.92	1.09	1.30	1.59	1.84	2.25	2.60	3.2	4.1	5.0	5.8	6.5	7.1
1/4YH6020		1/4	0.156	9/16 Hex	13/16	1.41	1.67	2.00	2.45	2.83	3.5	4.0	4.9	6.3	7.7	8.9	10	11	
3/8YH6030		3/8	0.188	11/16 Hex	21/8	2.12	2.51	3.00	3.7	4.2	5.2	6.0	7.3	9.5	11.6	13.4	15	16	
3/8YH6040		3/8	0.219	11/16 Hex	21/8	2.83	3.3	4.0	4.9	5.7	6.9	8.0	9.8	12.6	15	18	20	22	
3/8YH6053		3/8	0.250	11/16 Hex	21/8	3.7	4.4	5.3	6.5	7.5	9.2	10.6	13.0	17	21	24	27	29	
3/8YH6082		3/8	0.313	11/16 Hex	21/8	5.8	6.9	8.2	10.0	11.6	14.2	16.4	20.1	25.9	32	37	41	45	
1/2YH60120		1/2	0.375	7/8 Hex	21/2	8.5	10.0	12.0	14.7	17.0	20.8	24.0	29.4	38	46	54	60	66	
1/2YH60164		1/2	0.438	7/8 Hex	21/2	11.6	13.7	16.4	20.1	23.2	28.4	33	40	52	64	73	82	90	
3/4YH60210		3/4	0.500	1 1/16 Hex	27/8	14.8	17.6	21.0	25.7	29.7	36	42	51	66	81	94	105	115	
1YH60340		1	0.625	1 3/8 Hex	31/16	24.0	28.4	34	42	48	59	68	83	108	132	152	170	186	
1YH60470		1	0.750	1 3/8 Hex	31/16	33	39	47	58	66	81	94	115	149	182	210	235	257	
90°	1/4YH9007	1/4	0.094	9/16 Hex	13/16	0.49	0.59	0.70	0.86	0.99	1.21	1.40	1.71	2.21	2.71	3.13	3.5	3.8	
	1/4YH9013	1/4	0.125	9/16 Hex	13/16	0.92	1.09	1.30	1.59	1.84	2.25	2.60	3.2	4.1	5.0	5.8	6.5	7.1	
	1/4YH9020	1/4	0.156	9/16 Hex	13/16	1.41	1.67	2.00	2.45	2.83	3.5	4.0	4.9	6.3	7.7	8.9	10	11	
	3/8YH9030	3/8	0.188	11/16 Hex	21/8	2.12	2.51	3.00	3.7	4.2	5.2	6.0	7.3	9.5	11.6	13.4	15	16	
	3/8YH9040	3/8	0.219	11/16 Hex	21/8	2.83	3.3	4.0	4.9	5.7	6.9	8.0	9.8	12.6	15	18	20	22	
	3/8YH9053	3/8	0.250	11/16 Hex	21/8	3.7	4.4	5.3	6.5	7.5	9.2	10.6	13.0	17	21	24	27	29	
	3/8YH9082	3/8	0.313	11/16 Hex	21/8	5.8	6.9	8.2	10.0	11.6	14.2	16.4	20.1	25.9	32	37	41	45	
	1/2YH90120	1/2	0.375	7/8 Hex	21/2	8.5	10.0	12.0	14.7	17.0	20.8	24.0	29.4	38	46	54	60	66	
	1/2YH90164	1/2	0.438	7/8 Hex	21/2	11.6	13.7	16.4	20.1	23.2	28.4	33	40	52	64	73	82	90	
	3/4YH90210	3/4	0.500	1 1/16 Hex	27/8	14.8	17.6	21.0	25.7	29.7	36	42	51	66	81	94	105	115	
	1YH90340	1	0.625	1 3/8 Hex	31/16	24.0	28.4	34	42	48	59	68	83	108	132	152	170	186	
	1YH90470	1	0.750	1 3/8 Hex	31/16	33	39	47	58	66	81	94	115	149	182	210	235	257	
120°	1/4YH12007	1/4	0.094	9/16 Hex	13/16	0.49	0.59	0.70	0.86	0.99	1.21	1.40	1.71	2.21	2.71	3.13	3.5	3.8	
	1/4YH12013	1/4	0.125	9/16 Hex	13/16	0.92	1.09	1.30	1.59	1.84	2.25	2.60	3.2	4.1	5.0	5.8	6.5	7.1	
	1/4YH12020	1/4	0.156	9/16 Hex	13/16	1.41	1.67	2.00	2.45	2.83	3.5	4.0	4.9	6.3	7.7	8.9	10	11	
	3/8YH12030	3/8	0.188	11/16 Hex	21/8	2.12	2.51	3.00	3.7	4.2	5.2	6.0	7.3	9.5	11.6	13.4	15	16	
	3/8YH12040	3/8	0.219	11/16 Hex	21/8	2.83	3.3	4.0	4.9	5.7	6.9	8.0	9.8	12.6	15	18	20	22	
	3/8YH12053	3/8	0.250	11/16 Hex	21/8	3.7	4.4	5.3	6.5	7.5	9.2	10.6	13.0	17	21	24	27	29	
	3/8YH12082	3/8	0.313	11/16 Hex	21/8	5.8	6.9	8.2	10.0	11.6	14.2	16.4	20.1	25.9	32	37	41	45	
	1/2YH120120	1/2	0.375	7/8 Hex	21/2	8.5	10.0	12.0	14.7	17.0	20.8	24.0	29.4	38	46	54	60	66	
	1/2YH120164	1/2	0.438	7/8 Hex	21/2	11.6	13.7	16.4	20.1	23.2	28.4	33	40	52	64	73	82	90	
	3/4YH120210	3/4	0.500	1 1/16 Hex	27/8	14.8	17.6	21.0	25.7	29.7	36	42	51	66	81	94	105	115	
	1YH120340	1	0.625	1 3/8 Hex	31/16	24.0	28.4	34	42	48	59	68	83	108	132	152	170	186	
	1YH120470	1	0.750	1 3/8 Hex	31/16	33	39	47	58	66	81	94	115	149	182	210	235	257	

HOLLOW CONE

Spray Angle	MODEL NUMBER	Pipe Size (NPT)	Orifice Dia. (inches)	Dimensions		CAPACITY (GPM) AT VARIOUS PRESSURES (psi)													
				"A" (inches)	"L" (inches)	5 psi	7 psi	10 psi	15 psi	20 psi	30 psi	40 psi	60 psi	100 psi	150 psi	200 psi	250 psi	300 psi	
180°	1/4YH18013	1/4	0.125	9/16 Hex	1 ³ / ₁₆	0.92	1.09	1.30	1.59	1.84	2.25	2.60	3.2	4.1	5.0	5.8	6.5	7.1	
	1/4YH18020	1/4	0.156	9/16 Hex	1 ³ / ₁₆	1.41	1.67	2.00	2.45	2.83	3.5	4.0	4.9	6.3	7.7	8.9	10	11	
	3/8YH18030	3/8	0.188	11/16 Hex	2 ¹ / ₈	2.12	2.51	3.00	3.7	4.2	5.2	6.0	7.3	9.5	11.6	13.4	15	16	
	3/8YH18040	3/8	0.219	11/16 Hex	2 ¹ / ₈	2.83	3.3	4.0	4.9	5.7	6.9	8.0	9.8	12.6	15	18	20	22	
	3/8YH18053	3/8	0.250	11/16 Hex	2 ¹ / ₈	3.7	4.4	5.3	6.5	7.5	9.2	10.6	13.0	17	21	24	27	29	
	3/8YH18082	3/8	0.313	11/16 Hex	2 ¹ / ₈	5.8	6.9	8.2	10.0	11.6	14.2	16.4	20.1	25.9	32	37	41	45	
	1/2YH180120	1/2	0.375	7/8 Hex	2 ¹ / ₂	8.5	10.0	12.0	14.7	17.0	20.8	24.0	29.4	38	46	54	60	66	
	1/2YH180164	1/2	0.438	7/8 Hex	2 ¹ / ₂	11.6	13.7	16.4	20.1	23.2	28.4	33	40	52	64	73	82	90	
	3/4YH180210	3/4	0.500	1 ¹ / ₈ Hex	2 ⁷ / ₈	14.8	17.6	21.0	25.7	29.7	36	42	51	66	81	94	105	115	
	1YH180340	1	0.625	1 ³ / ₈ Hex	3 ¹¹ / ₁₆	24.0	28.4	34	42	48	59	68	83	108	132	152	170	186	
	1YH180470	1	0.750	1 ³ / ₈ Hex	3 ¹¹ / ₁₆	33	39	47	58	66	81	94	115	149	182	210	235	257	

ILH Series

In-line hollow cone spray nozzles

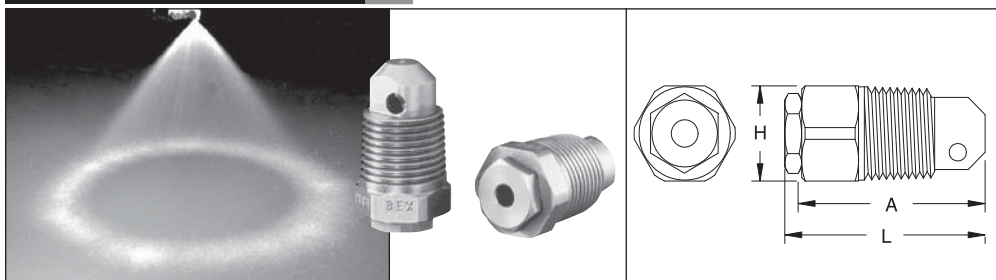

DIMENSIONS

MODEL NUMBER	Dim. A	Dim. L	Dim. H
3/8ILH	1.2	1.3	0.75
1/2ILH	1.3	1.5	1
3/4ILH	1.5	1.8	1.2
1 ¹ / ₂ ILH	2.4	2.6	2

SPRAY CHARACTERISTICS:

ILH series in-line hollow-cone spray nozzles produce a very evenly distributed hollow-cone spray which emerges through the center axis of the nozzle body. At lower pressures, they produce medium sized,

uniform droplets. Finer droplets are produced at higher pressures.

CONSTRUCTION:

ILH series nozzles have large maximum free passage diameters to reduce clogging.

Interchangeable nozzle caps are easily removed for cleaning or inspection. Standard materials of construction for ILH series nozzles are brass, 303 and 316 stainless steel. Other body and cap materials are available upon request.

MODEL NUMBER	PIPE SIZE NPT	MAXIMUM FREE PASSAGE (inches)	CAPACITY (GPM) AT VARIOUS PRESSURES (psi)									
			5 psi	7 psi	10 psi	15 psi	20 psi	30 psi	40 psi	60 psi	80 psi	100 psi
3/8ILH2	3/8	0.078	--	--	0.20	0.24	0.28	0.35	0.40	0.49	0.57	0.63
3/8ILH3	3/8	0.094	0.21	0.25	0.30	0.37	0.42	0.52	0.60	0.73	0.85	0.95
3/8ILH5	3/8	0.109	0.35	0.42	0.50	0.61	0.71	0.87	1.00	1.22	1.41	1.58
3/8ILH8	3/8	0.156	0.57	0.67	0.80	0.98	1.13	1.39	1.60	1.96	2.3	2.5
3/8ILH10	3/8	0.116	0.71	0.84	1.00	1.22	1.41	1.73	2.0	2.4	2.8	3.2
3/8ILH14	3/8	0.156	0.99	1.17	1.40	1.71	1.98	2.4	2.8	3.4	4.0	4.4
1/2ILH5	1/2	0.125	0.35	0.42	0.50	0.61	0.71	0.87	1.00	1.22	1.41	1.58
1/2ILH8	1/2	0.156	0.57	0.67	0.80	0.98	1.13	1.39	1.60	1.96	2.3	2.5
12ILH10	1/2	0.172	0.71	0.84	1.00	1.22	1.41	1.73	2.0	2.4	2.8	3.2
1/2ILH15	1/2	0.172	1.06	1.25	1.50	1.84	2.1	2.6	3.0	3.7	4.2	4.7
1/2ILH20	1/2	0.188	1.41	1.67	2.0	2.4	2.8	3.5	4.0	4.9	5.7	6.3
1/2ILH25	1/2	0.203	1.77	2.1	2.5	3.1	3.5	4.3	5.0	6.1	7.1	7.9
3/4ILH5	3/4	0.125	0.35	0.42	0.50	0.61	0.71	0.87	1.00	1.22	1.41	1.58
3/4ILH8	3/4	0.156	0.57	0.67	0.80	0.98	1.13	1.39	1.60	1.96	2.3	2.5
3/4ILH10	3/4	0.172	0.71	0.84	1.00	1.22	1.41	1.73	2.00	2.45	2.83	3.16
3/4ILH15	3/4	0.219	1.06	1.25	1.50	1.84	2.12	2.60	3.00	3.67	4.24	4.74
3/4ILH20	3/4	0.250	1.41	1.67	2.0	2.4	2.8	3.5	4.0	4.9	5.7	6.3
3/4ILH25	3/4	0.281	1.77	2.1	2.5	3.1	3.5	4.3	5.0	6.1	7.1	7.9
3/4ILH50	3/4	0.281	3.5	4.2	5.0	6.1	7.1	8.7	10.0	12.2	14.1	15.8
1 ¹ / ₂ ILH40	1 ¹ / ₂	0.313	2.8	3.3	4.0	4.9	5.7	6.9	8.0	9.8	11.3	12.6
1 ¹ / ₂ ILH50	1 ¹ / ₂	0.375	3.5	4.2	5.0	6.1	7.1	8.7	10.0	12.2	14.1	15.8
1 ¹ / ₂ ILH70	1 ¹ / ₂	0.375	4.9	5.9	7.0	8.6	9.9	12.1	14.0	17.1	19.8	22
1 ¹ / ₂ ILH90	1 ¹ / ₂	0.375	6.4	7.5	9.0	11.0	12.7	15.6	18.0	22	25	28
1 ¹ / ₂ ILH110	1 ¹ / ₂	0.375	7.8	9.2	11.0	13.5	15.6	19.1	22	27	31	35

TYPICAL

APPLICATIONS:

- Dust Suppression
- Spray Ponds
- Metal Treatment
- Roof Cooling
- Brine Spraying
- Humidification
- Aerating

Spray Angle is standard 75 degrees at 40 p.s.i.

Some Wide-Angle models also available. Contact BEX.

"- -" means not recommended at this pressure.

HOLLOW CONE

Hydraulic atomizing nozzles

C Series



SPRAY CHARACTERISTICS:

C series hydraulic atomizing nozzles are designed and precision machined to provide a very fine hollow-cone spray using only the liquid pressure for atomizing.

CONSTRUCTION:

Several different styles of nozzle are available in brass, 303 and 316 stainless steel. The cap, core, and strainer are supplied in 316 stainless steel standard.

TYPICAL APPLICATIONS:

- Humidification/Moisture Addition
- Evaporative Cooling
- Steam De-superheating

SPECIAL FEATURES:

- Very fine hollow-cone spray
- Easy disassembly/assembly and cleaning
- Wide range of style and sizes

DIMENSIONS

NOZZLE TYPE	"L"	BODY	CAP
1/4FCL	1 ¹⁵ / ₁₆	13 ¹³ / ₁₆ HEX	11 ¹¹ / ₁₆ HEX
1/4CL	2 ¹ / ₈	13 ¹³ / ₁₆ HEX	11 ¹¹ / ₁₆ HEX
1/4FCM.5L	1 ⁷ / ₈	13 ¹³ / ₁₆ HEX	5 ⁵ / ₈ HEX
1/4CM.5L	2 ¹ / ₃₂	13 ¹³ / ₁₆ HEX	5 ⁵ / ₈ HEX
1/4FC	1 ¹⁵ / ₁₆	11 ¹¹ / ₁₆ HEX	11 ¹¹ / ₁₆ HEX
1/4C	1 ¹³ / ₃₂	11 ¹¹ / ₁₆ HEX	11 ¹¹ / ₁₆ HEX
1/4CC	2 ⁷ / ₃₂	9 ⁹ / ₁₆ HEX	N/A

HOLLOW CONE



CL STYLE

Two-piece body with removable cap, core and strainer.



C STYLE

Two piece body with removable cap and core.



CM.5L STYLE

1/2" NPT male wall mount body with removable cap, core and strainer.



CC STYLE*

One-piece body with core. (Add "L" for optional external strainer.)

Standard spray angle is 80° @ 40 p.s.i. (80° @ 100 p.s.i. for Models C4.7 and smaller)

MODEL NUMBER							CAPACITY (GPH) AT VARIOUS PRESSURES (psi)									
'CL' Style		'CM.5L' Style		'C' Style		'CC' Style	30 psi	40 psi	80 psi	100 psi	200 psi	300 psi	500 psi	700 psi	1000 psi	
FEMALE	MALE	FEMALE	MALE	FEMALE	MALE	MALE										
1/4FC1.9L	1/4C1.9L	1/4FC1.9M.5L	1/4C1.9M.5L	1/4FC1.9	1/4C1.9	1/4CC1.9	0.51	0.59	0.83	0.93	1.32	1.61	2.1	2.5	2.9	
1/4FC2.4L	1/4C2.4L	1/4FC2.4M.5L	1/4C2.4M.5L	1/4FC2.4	1/4C2.4	1/4CC2.4	0.64	0.74	1.05	1.18	1.67	2.0	2.6	3.1	3.7	
1/4FC3.0L	1/4C3.0L	1/4FC3.0M.5L	1/4C3.0M.5L	1/4FC3.0	1/4C3.0	1/4CC3.0	0.81	0.93	1.32	1.47	2.1	2.5	3.3	3.9	4.7	
1/4FC3.8L	1/4C3.8L	1/4FC3.8M.5L	1/4C3.8M.5L	1/4FC3.8	1/4C3.8	1/4CC3.8	1.02	1.18	1.67	1.86	2.6	3.2	4.2	4.9	5.9	
1/4FC4.7L	1/4C4.7L	1/4FC4.7M.5L	1/4C4.7M.5L	1/4FC4.7	1/4C4.7	1/4CC4.7	1.26	1.46	2.1	2.3	3.3	4.0	5.2	6.1	7.3	
1/4FC5.9L	1/4C5.9L	1/4FC5.9M.5L	1/4C5.9M.5L	1/4FC5.9	1/4C5.9	1/4CC5.9	1.59	1.83	2.6	2.9	4.1	5.0	6.5	7.7	9.2	
1/4FC7.4L	1/4C7.4L	1/4FC7.4M.5L	1/4C7.4M.5L	1/4FC7.4	1/4C7.4	1/4CC7.4	1.99	2.3	3.2	3.6	5.1	6.3	8.1	9.6	11.5	
1/4FC9.2L	1/4C9.2L	1/4FC9.2M.5L	1/4C9.2M.5L	1/4FC9.2	1/4C9.2	1/4CC9.2	2.5	2.9	4.0	4.5	6.4	7.8	10.1	11.9	14.3	
1/4FC12L	1/4C12L	1/4FC12M.5L	1/4C12M.5L	1/4FC12	1/4C12	1/4CC12	3.2	3.7	5.3	5.9	8.3	10.2	13.2	15.6	18.6	
1/4FC14L	1/4C14L	1/4FC14M.5L	1/4C14M.5L	1/4FC14	1/4C14	1/4CC14	3.8	4.3	6.1	6.9	9.7	11.9	15.4	18.2	22	
1/4FC18L	1/4C18L	1/4FC18M.5L	1/4C18M.5L	1/4FC18	1/4C18	1/4CC18	4.8	5.6	7.9	8.8	12.5	15.3	19.7	23	28	
1/4FC23L	1/4C23L	1/4FC23M.5L	1/4C23M.5L	1/4FC23	1/4C23	1/4CC23	6.18	7.1	10.1	11.3	16.0	19.5	25	30	36	
1/4FC28L	1/4C28L	1/4FC28M.5L	1/4C28M.5L	1/4FC28	1/4C28	1/4CC28	7.5	8.7	12.3	13.7	19.4	24	31	36	43	
1/4FC35L	1/4C35L	1/4FC35M.5L	1/4C35M.5L	1/4FC35	1/4C35	1/4CC35	9.4	10.9	15.4	17.2	24	30	38	45	54	
1/4FC44L	1/4C44L	1/4FC44M.5L	1/4C44M.5L	1/4FC44	1/4C44	1/4CC44	11.8	13.7	19.3	22	31	37	48	57	68	
1/4FC55L	1/4C55L	1/4FC55M.5L	1/4C55M.5L	1/4FC55	1/4C55	1/4CC55	14.8	17.1	24	27	38	47	60	71	85	
1/4FC69L	1/4C69L	1/4FC69M.5L	1/4C69M.5L	1/4FC69	1/4C69	1/4CC69	18.5	21	30	34	48	59	76	90	107	
1/4FC86L	1/4C86L	1/4FC86M.5L	1/4C86M.5L	1/4FC86	1/4C86	1/4CC86	23	27	38	42	60	73	94	112	133	

*Some 1/8 NPT CC Styles are available

CW Series

Wide angle hydraulic atomizing nozzles



DIMENSIONS

NOZZLE TYPE	"L"	BODY	CAP
1/4FCWL	2	13/16 HEX	11/16 HEX
1/4CWL	2 3/16	13/16 HEX	11/16 HEX
1/4FCWM.5L	1 15/16	13/16 HEX	5/8 HEX
1/4CWM.5L	2 3/32	13/16 HEX	5/8 HEX
1/4FCW	2	11/16 HEX	11/16 HEX
1/4CW	1 15/32	11/16 HEX	11/16 HEX
1/4CCW	2 9/32	9/16 HEX	N/A

SPRAY CHARACTERISTICS:

CW series wide angle hydraulic atomizing nozzles are precision machined to provide a very fine wide angle hollow-cone spray using only the liquid pressure for atomizing.

TYPICAL APPLICATIONS:

- Humidification/Moisture Addition
- Evaporative Cooling
- Steam De-superheating

CONSTRUCTION:

Several different styles of nozzle are available in brass, 303 and 316 stainless steel. The cap, core and strainer are supplied in 316 stainless steel standard.

SPECIAL FEATURES:

- Very fine wide angle hollow-cone spray
- Easy disassembly/assembly and cleaning
- Wide range of styles and sizes



CWL STYLE

Two-piece body with removable cap, core and strainer.



CW STYLE

Two-piece body with removable cap and core.



CWM.5L STYLE

1/2" NPT male wallmount body with removable cap, core and strainer.



CCW STYLE*

One-piece body with core (Add "L" for optional external strainer.)

Standard spray angle is 150° @ 40 p.s.i.

MODEL NUMBER							CAPACITY (GPH) AT VARIOUS PRESSURES (psi)									
'CWL' Style		'CWM.5L' Style		'CW' Style		'CCW' Style	30 psi	40 psi	80 psi	100 psi	200 psi	300 psi	500 psi	700 psi	1000 psi	
FEMALE	MALE	FEMALE	MALE	FEMALE	MALE	MALE										
1/4FC5.9WL	1/4C5.9WL	1/4FC5.9WM.5L	1/4C5.9WM.5L	1/4FC5.9W	1/4C5.9W	1/4CC5.9W	1.59	1.83	2.6	2.9	4.1	5.0	6.5	7.7	9.2	
1/4FC7.4WL	1/4C7.4WL	1/4FC7.4WM.5L	1/4C7.4WM.5L	1/4FC7.4W	1/4C7.4W	1/4CC7.4W	1.99	2.3	3.2	3.6	5.1	6.3	8.1	9.6	11.5	
1/4FC9.2WL	1/4C9.2WL	1/4FC9.2WM.5L	1/4C9.2WM.5L	1/4FC9.2W	1/4C9.2W	1/4CC9.2W	2.5	2.9	4.0	4.5	6.4	7.8	10.1	11.9	14.3	
1/4FC12WL	1/4C12WL	1/4FC12WM.5L	1/4C12WM.5L	1/4FC12W	1/4C12W	1/4CC12W	3.2	3.7	5.3	5.9	8.3	10.2	13.2	15.6	18.6	
1/4FC14WL	1/4C14WL	1/4FC14WM.5L	1/4C14WM.5L	1/4FC14W	1/4C14W	1/4CC14W	3.8	4.3	6.1	6.9	9.7	11.9	15.4	18.2	22	
1/4FC18WL	1/4C18WL	1/4FC18WM.5L	1/4C18WM.5L	1/4FC18W	1/4C18W	1/4CC18W	4.8	5.6	7.9	8.8	12.5	15.3	19.7	23	28	
1/4FC23WL	1/4C23WL	1/4FC23WM.5L	1/4C23WM.5L	1/4FC23W	1/4C23W	1/4CC23W	6.18	7.1	10.1	11.3	16.0	19.5	25	30	36	
1/4FC28WL	1/4C28WL	1/4FC28WM.5L	1/4C28WM.5L	1/4FC28W	1/4C28W	1/4CC28W	7.5	8.7	12.3	13.7	19.4	24	31	36	43	

*Some 1/8 N.P.T. CCW Styles are available

HOLLOW CONE

High capacity hollow cone spray nozzles

R Series

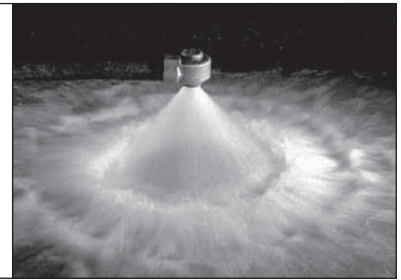
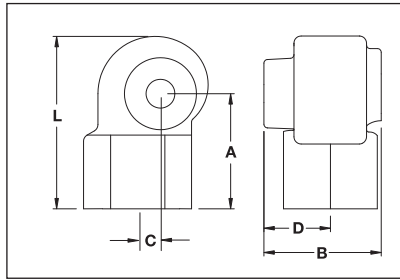

At 15 p.s.i.: Circular distribution with larger flow rates.

SPRAY CHARACTERISTICS:

A high capacity hollow cone spray pattern with uniform distribution. The large body and orifice diameters minimize clogging.

CONSTRUCTION:

One piece cast construction. Standard material is 316 stainless steel. All the R series nozzles have a female NPT pipe connection. Bronze and cast iron available on a limited, special order basis.

TYPICAL APPLICATIONS:

- Aeration & Pollution Control
- Cooling Ponds
- Scrubbing and Washing Gases and Fumes
- Cooling Coil
- Dust Proofing
- Chemical Processes

DIMENSIONS

MODEL NUMBER	Dim. A	Dim. B	Dim. C	Dim. D	Dim. L
1R	2	2 ¹ / ₈	1 ¹ / ₈	1 ¹ / ₈	2 ³ / ₄
1 ¹ / ₄ R	2 ¹ / ₈	2 ¹ / ₄	1 ¹ / ₂	1 ¹ / ₄	3 ¹ / ₈
1 ¹ / ₂ R	2 ³ / ₈	3	9 ⁹ / ₁₆	1 ³ / ₄	3 ³ / ₄
2R	2 ³ / ₄	3 ⁷ / ₈	1	2 ¹ / ₄	4 ³ / ₄
2 ¹ / ₂ R	3 ¹ / ₂	4 ³ / ₄	1 ¹ / ₈	2 ³ / ₄	4 ³ / ₄

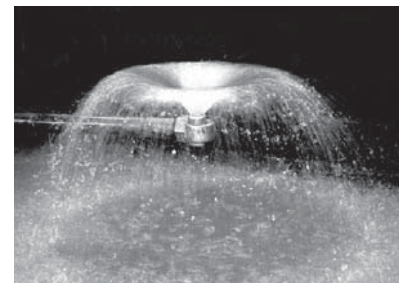

At 1 p.s.i.: Wide spray angle with large droplets and minimal misting.

HOLLOW CONE

MODEL NUMBER	PIPE SIZE NPT	MAXIMUM FREE PASSAGE (inches)	CAPACITY (GPM) AT VARIOUS PRESSURES (psi)												SPRAY ANGLE @		
			2 psi	3 psi	5 psi	7 psi	10 psi	15 psi	20 psi	30 psi	40 psi	60 psi	80 psi	100 psi	7 psi	20 psi	60 psi
1R10	1	1/2	4.5	5.5	7.1	8.4	10.0	12.2	14.1	17.3	20	24	28	32	65°	72°	73°
1R12	1	17/32	5.4	6.6	8.5	10.0	12.0	14.7	17.0	21	24	29	34	38	71°	74°	75°
1R14	1	9/16	6.3	7.7	9.9	11.7	14.0	17.1	19.8	24	28	34	40	44	74°	79°	80°
1R16	1	9/16	7.2	8.8	11.3	13.4	16.0	19.6	23	28	32	39	45	51	77°	83°	83°
1R18	1	9/16	8.0	9.9	12.7	15.1	18.0	22	25	31	36	44	51	57	80°	86°	76°
1 ¹ / ₄ R12	1 ¹ / ₄	17/32	5.4	6.6	8.5	10.0	12.0	14.7	17.0	21	24	29	34	38	64°	68°	69°
1 ¹ / ₄ R14	1 ¹ / ₄	9/16	6.3	7.7	9.9	11.7	14.0	17.1	19.8	24	28	34	40	44	66°	71°	71°
1 ¹ / ₄ R16	1 ¹ / ₄	5/8	7.2	8.8	11.3	13.4	16.0	19.6	23	28	32	39	45	51	71°	75°	75°
1 ¹ / ₄ R18	1 ¹ / ₄	5/8	8.0	9.9	12.7	15.1	18.0	22	25	31	36	44	51	57	76°	78°	79°
1 ¹ / ₄ R21	1 ¹ / ₄	5/8	9.4	11.5	14.8	17.6	21	26	30	36	42	51	59	66	79°	82°	82°
1 ¹ / ₄ R24	1 ¹ / ₄	5/8	10.7	13.1	17.0	20	24	29	34	42	48	59	68	76	81°	76°	86°
1 ¹ / ₂ R18	1 ¹ / ₂	5/8	8.0	9.9	12.7	15.1	18.0	22	25	31	36	44	51	57	66°	70°	71°
1 ¹ / ₂ R21	1 ¹ / ₂	11/16	9.4	11.5	14.8	17.6	21	26	30	36	42	51	59	66	70°	74°	74°
1 ¹ / ₂ R24	1 ¹ / ₂	3/4	10.7	13.1	17.0	20	24	29	34	42	48	59	68	76	73°	76°	76°
1 ¹ / ₂ R28	1 ¹ / ₂	3/4	12.5	15.3	19.8	23	28	34	40	48	56	69	79	89	76°	79°	80°
1 ¹ / ₂ R32	1 ¹ / ₂	3/4	14.3	17.5	23	27	32	39	45	55	64	78	91	101	79°	84°	84°
1 ¹ / ₂ R37	1 ¹ / ₂	3/4	16.5	20	26	31	37	45	52	64	74	91	105	117	84°	88°	88°
2R37	2	7/8	16.5	20	26	31	37	45	52	64	74	91	105	117	62°	64°	65°
2R43	2	15/16	19.2	24	30	36	43	53	61	74	86	105	122	136	66°	70°	72°
2R49	2	1	21.9	27	35	41	49	60	69	85	98	120	139	155	70°	72°	73°
2R57	2	1 ¹ / ₁₆	25.5	31	40	48	57	70	81	99	114	140	161	180	74°	77°	77°
2R65	2	1 ¹ / ₁₆	29.1	36	46	54	65	80	92	113	130	159	184	206	75°	79°	79°
2R75	2	1 ¹ / ₁₆	33.5	41	53	63	75	92	106	130	150	184	212	237	78°	81°	81°
2R86	2	1 ¹ / ₁₆	38.5	47	61	72	86	105	122	149	172	211	243	272	86°	88°	88°
2 ¹ / ₂ R75	2 ¹ / ₂	1 ⁹ / ₁₆	33.5	41	53	63	75	92	106	130	150	184	212	237	67°	72°	72°
2 ¹ / ₂ R86	2 ¹ / ₂	1 ⁵ / ₁₆	38.5	47	61	72	86	105	122	149	172	211	243	272	73°	76°	76°
2 ¹ / ₂ R100	2 ¹ / ₂	1 ⁵ / ₁₆	44.7	55	71	84	100	122	141	173	200	245	283	316	79°	83°	84°
2 ¹ / ₂ R115	2 ¹ / ₂	1 ⁵ / ₁₆	51.4	63	81	96	115	141	163	199	230	282	325	364	80°	84°	85°
2 ¹ / ₂ R132	2 ¹ / ₂	1 ⁵ / ₁₆	59.0	72	93	110	132	162	187	229	264	323	373	417	82°	87°	87°

Quick Disconnect Nozzles

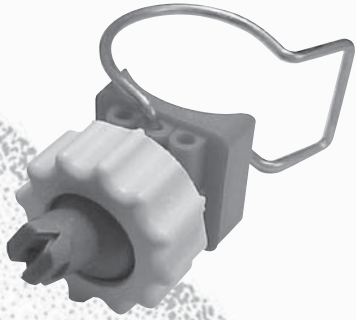

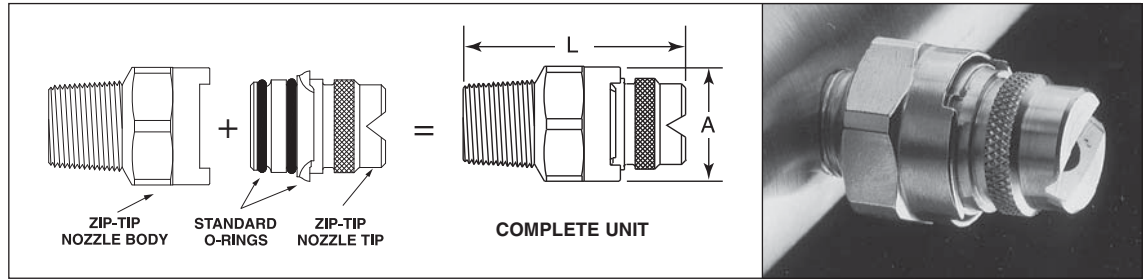

BEX ZIP-TIP® quick-disconnect spray nozzles are designed to allow fast and easy installation and removal of spray nozzle tips and adapter fittings, while providing positive alignment between nozzle body and nozzle tip. No tools are required to install or remove ZIP-TIP nozzle tips or adapters. Installation involves simply inserting a ZIP-TIP nozzle tip into a ZIP-TIP nozzle body, pressing lightly, and twisting in a clockwise direction until the nozzle tip or adapter snaps into aligned position. ZIP-TIP nozzles utilize standard “O-ring” seals,

where the “O-rings” are located on, and removed with, the nozzle tip. These seals are supplied with each new spray nozzle tip or adapter fitting. Any “Z” series (e.g. “ZF”), ZIP-TIP nozzle tip or adapter will fit any “Z” series ZIP-TIP nozzle body. Likewise, the “ZL” series (e.g. “ZLF”), ZIP-TIP nozzle tip or adapter for larger capacities will fit any “ZL” series ZIP-TIP nozzle body (note that a minimum pipe size is required for specific capacities). ZIP-TIP nozzles are available in 303 and 316 stainless steel as well as brass, and all are supplied with

VITON® seals standard. Other nozzle tip, nozzle body, and seal materials are available upon request. A wide range of styles and capacities of ZIP-TIP nozzle tips and nozzle bodies for flat, full-cone, and hollow-cone spray patterns are available. ZIP-TIP spray nozzles are rated to 300 psi. (NOTE: Metal and molded plastic ZIP-TIP components are not interchangeable).

U.S. Patent No. 5,421,522

ZIP-TIP NOZZLE INSTALLATION & REMOVAL

- NO TOOLS REQUIRED for ZIP-TIP nozzle tip installation or removal
- POSITIVE ALIGNMENT of spray pattern
- “Light-lock” feature allows for easy removal
- Seals located on and removed with nozzle tip for easy flushing
- New seals supplied with each new nozzle tip (VITON® standard)
- Uses standard “O-RING” seals, available in a variety of materials
- High flow capacities in a small assembly size



ZIP-TIP®

ZIP-TIP BODIES AND ADAPTERS



ZBD, ZLBD

1/8" - 3/4" NPT Male Only
Brass, 303 & 316 SS



ZHB Hose Bar Connector

Great for connecting to hoses to threaded pieces. Available in 1/4 and 3/8".



ZTA, ZLTA

1/8" - 1/2" NPT Female Only
Brass, 303 & 316 SS



ZPLUG, ZLPLUG

To shut off individual nozzles
Brass, 303 & 316 SS



ZAJ, ZLAJ

1/8" - 1/2" NPT Male Only
Brass, 303 & 316 SS

ZF Series

Flat "V" spray nozzles

DIMENSIONS

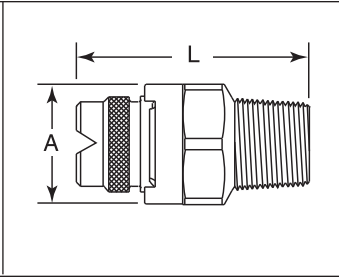
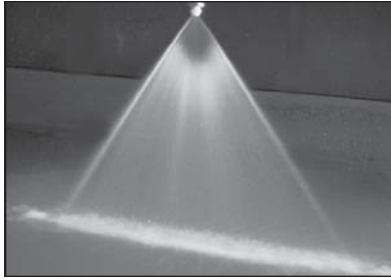

MODEL	DIM "L"	DIM "A"
1/8 ZF	1.60	0.97
1/4 ZF	1.70	0.97
3/8 ZF	1.73	0.97
1/2 ZF	1.80	0.97
3/8 ZLF	2.11	1.25
1/2 ZLF	2.19	1.25

SPRAY CHARACTERISTICS:

ZF-Series spray nozzles produce a flat, fan-shaped spray pattern with spray angles available from 15° to 110° measured at 40 psi. Spray angles generally increase with pressure, as shown in the capacity table.

Spray density tapers off toward the outside of these sprays, to permit overlapping of spray patterns while maintaining uniform spray density.

CONSTRUCTION:

The tip models listed are machined from bar stock and are one piece construction. Standard materials are brass, mild steel, 303 stainless steel and 316 stainless steel. All bodies are available in either NPT or BSPT threads. Please see page 66 for molded plastic models.

TYPICAL APPLICATIONS:

Suitable for a variety of washing and spraying applications.

- Parts Cleaning
- Metal Washing
- Foam Control
- Asphalt Spraying
- Gravel Washing
- Vehicle Washing
- Fertilizer Spraying
- Dishwashers

SPRAY ANGLE @ 40psi	ZF MODEL	ZLF MODEL	EQUIV. ORIFICE DIAMETER (inches)	CAPACITY (GPM) AT VARIOUS PRESSURES (psi)													SPRAY ANGLE @			
				5 psi	7 psi	10 psi	15 psi	20 psi	30 psi	40 psi	50 psi	60 psi	80 psi	100 psi	150 psi	300 psi	20 psi	40 psi	80 psi	
110°	ZF11003		.041	0.11	0.13	0.15	0.18	0.21	0.26	0.30	0.34	0.37	0.42	0.47	0.58	0.82	92°	110°	118°	
	ZF11004		.047	0.14	0.17	0.20	0.24	0.28	0.35	0.40	0.45	0.49	0.57	0.63	0.77	1.10	90°	110°	112°	
	ZF11005		.053	0.18	0.21	0.25	0.31	0.35	0.43	0.50	0.56	0.61	0.71	0.79	0.97	1.37	96°	110°	114°	
	ZF11006		.058	0.21	0.25	0.30	0.37	0.42	0.52	0.60	0.67	0.73	0.85	0.95	1.16	1.64	97°	110°	115°	
	ZF11008		.067	0.28	0.33	0.40	0.49	0.57	0.69	0.80	0.89	0.98	1.13	1.26	1.55	2.19	100°	110°	115°	
	ZF11010		.075	0.35	0.42	0.50	0.61	0.71	0.87	1.00	1.12	1.22	1.41	1.58	1.94	2.74	102°	110°	115°	
	ZF11015		.091	0.53	0.63	0.75	0.92	1.06	1.30	1.50	1.68	1.84	2.12	2.37	2.90	4.1	102°	110°	115°	
	ZF11020		.105	0.71	0.84	1.00	1.22	1.41	1.73	2.00	2.24	2.45	2.83	3.2	3.9	5.5	103°	110°	112°	
	ZF11030		.129	1.06	1.25	1.50	1.84	2.12	2.60	3.00	3.4	3.7	4.2	4.7	5.8	8.2	103°	110°	115°	
	ZF11040		.149	1.41	1.67	2.00	2.45	2.83	3.5	4.0	4.5	4.9	5.7	6.3	7.7	11.0	103°	110°	115°	
	ZF11050		.167	1.77	2.09	2.50	3.06	3.5	4.3	5.0	5.6	6.1	7.1	7.9	9.7	13.7	107°	110°	116°	
	ZF11060		.182	2.12	2.51	3.00	3.7	4.2	5.2	6.0	6.7	7.3	8.5	9.5	11.6	16.4	103°	110°	115°	
	ZF11070		.197	2.47	2.93	3.5	4.3	4.9	6.1	7.0	7.8	8.6	9.9	11.1	13.6	19.2	107°	110°	115°	
		ZLF11080		.211	2.83	3.35	4.0	4.9	5.7	6.9	8.0	8.9	9.8	11.3	12.6	15.5	21.9	107°	110°	115°
		ZLF110100		.236	3.54	4.18	5.0	6.1	7.1	8.7	10.0	11.2	12.2	14.1	15.8	19.4	27.4	106°	110°	115°
	ZLF110120		.258	4.24	5.02	6.0	7.3	8.5	10.4	12.0	13.4	14.7	17.0	19.0	23.2	32.9	108°	110°	117°	
	ZLF110150		.289	5.30	6.27	7.5	9.2	10.6	13.0	15.0	16.8	18.4	21.2	23.7	29.0	41	104°	110°	115°	
	ZLF110200		.333	7.07	8.37	10.0	12.2	14.1	17.3	20.0	22.4	24.5	28.3	32	39	55	106°	110°	116°	
	ZLF110400		.471	14.1	16.7	20.0	24.5	28.3	35	40	45	49	57	63	78	110	105°	110°	115°	
95°	ZF9503		.041	0.11	0.13	0.15	0.18	0.21	0.26	0.30	0.34	0.37	0.42	0.47	0.58	0.82	86°	95°	101°	
	ZF9504		.047	0.14	0.17	0.20	0.24	0.28	0.35	0.40	0.45	0.49	0.57	0.63	0.77	1.10	86°	95°	101°	
	ZF9505		.053	0.18	0.21	0.25	0.31	0.35	0.43	0.50	0.56	0.61	0.71	0.79	0.97	1.37	86°	95°	101°	
	ZF9506		.058	0.21	0.25	0.30	0.37	0.42	0.52	0.60	0.67	0.73	0.85	0.95	1.16	1.64	86°	95°	101°	
	ZF9508		.067	0.28	0.33	0.40	0.49	0.57	0.69	0.80	0.89	0.98	1.13	1.26	1.55	2.2	86°	95°	100°	
	ZF9510		.075	0.35	0.42	0.50	0.61	0.71	0.87	1.00	1.12	1.22	1.41	1.58	1.94	2.7	88°	95°	99°	
	ZF9515		.091	0.53	0.63	0.75	0.92	1.06	1.30	1.5	1.68	1.84	2.1	2.4	2.9	4.1	90°	95°	100°	
	ZF9520		.105	0.71	0.84	1.00	1.22	1.41	1.73	2.0	2.2	2.4	2.8	3.2	3.9	5.5	89°	95°	99°	
	ZF9530		.129	1.06	1.25	1.50	1.84	2.1	2.6	3.0	3.4	3.7	4.2	4.7	5.8	8.2	90°	95°	101°	
	ZF9540		.149	1.41	1.67	2.0	2.4	2.8	3.5	4.0	4.5	4.9	5.7	6.3	7.7	11.0	90°	95°	100°	
	ZF9550		.167	1.77	2.1	2.5	3.1	3.5	4.3	5.0	5.6	6.1	7.1	7.9	9.7	13.7	91°	95°	101°	
	ZF9560		.182	2.1	2.5	3.0	3.7	4.2	5.2	6.0	6.7	7.3	8.5	9.5	11.6	16.4	92°	95°	102°	
	ZF9570		.197	2.5	2.9	3.5	4.3	4.9	6.1	7.0	7.8	8.6	9.9	11.1	13.6	19.2	92°	95°	103°	
		ZLF9580		.211	2.8	3.3	4.0	4.9	5.7	6.9	8.0	8.9	9.8	11.3	12.6	15.5	21.9	92°	95°	103°
		ZLF95100		.236	3.5	4.2	5.0	6.1	7.1	8.7	10.0	11.2	12.2	14.1	15.8	19.4	27	92°	95°	103°
	ZLF95120		.258	4.2	5.0	6.0	7.3	8.5	10.4	12.0	13.4	14.7	17.0	19.0	23.2	32.9	92°	95°	103°	
	ZLF95150		.289	5.3	6.3	7.5	9.2	10.6	13.0	15.0	16.8	18.4	21	24	29	41	92°	95°	102°	

ZIP-TIP®

ZF Series

Flat "V" spray nozzles continued

DIMENSIONS

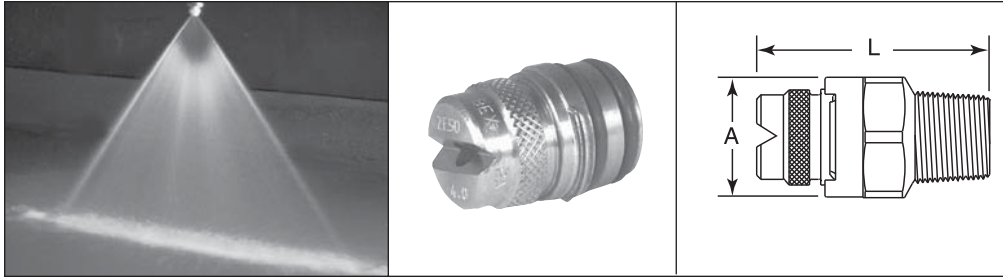

MODEL	DIM "L"	DIM "A"
1/8 ZF	1.60	0.97
1/4 ZF	1.70	0.97
3/8 ZF	1.73	0.97
1/2 ZF	1.80	0.97
3/8 ZLF	2.11	1.25
1/2 ZLF	2.19	1.25

SPRAY ANGLE @ 40psi	ZF MODEL	ZLF MODEL	EQUIV. ORIFICE DIAMETER (inches)	CAPACITY (GPM) AT VARIOUS PRESSURES (psi)													SPRAY ANGLE @		
				5 psi	7 psi	10 psi	15 psi	20 psi	30 psi	40 psi	50 psi	60 psi	80 psi	100 psi	150 psi	300 psi	20 psi	40 psi	80 psi
50°		ZLF5080	0.211	2.8	3.3	4.0	4.9	5.7	6.9	8.0	8.9	9.8	11.3	12.6	15.5	21.9	44°	50°	52°
		ZLF50100	0.236	3.5	4.2	5.0	6.1	7.1	8.7	10.0	11.2	12.2	14.1	15.8	19.4	27	44°	50°	52°
		ZLF50120	0.258	4.2	5.0	6.0	7.3	8.5	10.4	12.0	13.4	14.7	17.0	19.0	23	33	44°	50°	53°
		ZLF50150	0.289	5.3	6.3	7.5	9.2	10.6	13.0	15.0	16.8	18.4	21.2	23.7	29.0	41	46°	50°	52°
		ZLF50200	0.333	7.1	8.4	10.0	12.2	14.1	17.3	20.0	22.4	24.5	28	32	39	55	46°	50°	54°
		ZLF50300	0.408	10.6	12.5	15.0	18.4	21	26	30	34	37	42	47	58	82	47°	50°	54°
		ZLF50400	0.466	14.1	16.7	20.0	24.5	28.3	34.6	40	45	49	57	63	77	110	47°	50°	54°
40°	ZF4002		0.034	0.07	0.08	0.10	0.12	0.14	0.17	0.20	0.22	0.24	0.28	0.32	0.39	0.55	26°	40°	46°
	ZF4003		0.041	0.11	0.13	0.15	0.18	0.21	0.26	0.30	0.34	0.37	0.42	0.47	0.58	0.82	30°	40°	45°
	ZF4004		0.047	0.14	0.17	0.20	0.24	0.28	0.35	0.40	0.45	0.49	0.57	0.63	0.77	1.10	32°	40°	45°
	ZF4005		0.053	0.18	0.21	0.25	0.31	0.35	0.43	0.50	0.56	0.61	0.71	0.79	0.97	1.37	35°	40°	44°
	ZF4006		0.058	0.21	0.25	0.30	0.37	0.42	0.52	0.60	0.67	0.73	0.85	0.95	1.16	1.64	37°	40°	44°
	ZF4008		0.067	0.28	0.33	0.40	0.49	0.57	0.69	0.80	0.89	0.98	1.13	1.26	1.55	2.2	35°	40°	43°
	ZF4010		0.075	0.35	0.42	0.50	0.61	0.71	0.87	1.00	1.12	1.22	1.41	1.58	1.94	2.7	30°	40°	43°
	ZF4015		0.091	0.53	0.63	0.75	0.92	1.06	1.30	1.50	1.68	1.84	2.1	2.4	2.9	4.1	35°	40°	41°
	ZF4020		0.105	0.71	0.84	1.00	1.22	1.41	1.73	2.0	2.2	2.4	2.8	3.2	3.9	5.5	33°	40°	43°
	ZF4030		0.129	1.06	1.25	1.50	1.84	2.1	2.6	3.0	3.4	3.7	4.2	4.7	5.8	8.2	34°	40°	45°
	ZF4040		0.149	1.41	1.67	2.0	2.4	2.8	3.5	4.0	4.5	4.9	5.7	6.3	7.7	11.0	33°	40°	43°
	ZF4050		0.167	1.77	2.1	2.5	3.1	3.5	4.3	5.0	5.6	6.1	7.1	7.9	9.7	13.7	35°	40°	46°
	ZF4060		0.182	2.1	2.5	3.0	3.7	4.2	5.2	6.0	6.7	7.3	8.5	9.5	11.6	16.4	37°	40°	48°
	ZF4070		0.197	2.47	2.93	3.5	4.3	4.9	6.1	7.0	7.8	8.6	9.9	11.1	13.6	19.2	36°	40°	47°
		ZLF4080	0.211	2.8	3.3	4.0	4.9	5.7	6.9	8.0	8.9	9.8	11.3	12.6	15.5	21.9	35°	40°	46°
		ZLF40100	0.236	3.5	4.2	5.0	6.1	7.1	8.7	10.0	11.2	12.2	14.1	15.8	19.4	27	33°	40°	44°
		ZLF40120	0.258	4.2	5.0	6.0	7.3	8.5	10.4	12.0	13.4	14.7	17.0	19.0	23	33	36°	40°	43°
	ZLF40150	0.289	5.3	6.3	7.5	9.2	10.6	13.0	15.0	16.8	18.4	21.2	23.7	29.0	41	36°	40°	43°	
	ZLF40200	0.333	7.1	8.4	10.0	12.2	14.1	17.3	20.0	22.4	24.5	28	32	39	55	37°	40°	44°	
	ZLF40400	0.466	14.1	16.7	20.0	24.5	28.3	34.6	40	45	49	57	63	77	110	38°	40°	43°	
25°	ZF2503		0.041	0.11	0.13	0.15	0.18	0.21	0.26	0.30	0.34	0.37	0.42	0.47	0.58	0.82	20°	25°	31°
	ZF2504		0.047	0.14	0.17	0.20	0.24	0.28	0.35	0.40	0.45	0.49	0.57	0.63	0.77	1.10	19°	25°	31°
	ZF2505		0.053	0.18	0.21	0.25	0.31	0.35	0.43	0.50	0.56	0.61	0.71	0.79	0.97	1.37	18°	25°	31°
	ZF2506		0.058	0.21	0.25	0.30	0.37	0.42	0.52	0.60	0.67	0.73	0.85	0.95	1.16	1.64	17°	25°	31°
	ZF2508		0.067	0.28	0.33	0.40	0.49	0.57	0.69	0.80	0.89	0.98	1.13	1.26	1.55	2.2	16°	25°	32°
	ZF2510		0.075	0.35	0.42	0.50	0.61	0.71	0.87	1.00	1.12	1.22	1.41	1.58	1.94	2.7	17°	25°	31°
	ZF2515		0.091	0.53	0.63	0.75	0.92	1.06	1.30	1.50	1.68	1.84	2.1	2.4	2.9	4.1	18°	25°	30°
	ZF2520		0.105	0.71	0.84	1.00	1.22	1.41	1.73	2.0	2.2	2.4	2.8	3.2	3.9	5.5	18°	25°	28°
	ZF2530		0.129	1.06	1.25	1.50	1.84	2.1	2.6	3.0	3.4	3.7	4.2	4.7	5.8	8.2	19°	25°	29°
	ZF2540		0.149	1.41	1.67	2.0	2.4	2.8	3.5	4.0	4.5	4.9	5.7	6.3	7.7	11.0	22°	25°	32°
	ZF2550		0.167	1.77	2.1	2.5	3.1	3.5	4.3	5.0	5.6	6.1	7.1	7.9	9.7	13.7	20°	25°	32°
	ZF2560		0.182	2.1	2.5	3.0	3.7	4.2	5.2	6.0	6.7	7.3	8.5	9.5	11.6	16.4	18°	25°	28°
	ZF2570		0.197	2.5	2.9	3.5	4.3	4.9	6.1	7.0	7.8	8.6	9.9	11.1	13.6	19.2	19°	25°	27°
		ZLF2580	0.211	2.83	3.3	4.0	4.9	5.7	6.9	8.0	8.9	9.8	11.3	12.6	15.5	21.9	20°	25°	27°
		ZLF25100	0.236	3.5	4.2	5.0	6.1	7.1	8.7	10.0	11.2	12.2	14.1	15.8	19.4	27	21°	25°	28°
		ZLF25120	0.258	4.2	5.0	6.0	7.3	8.5	10.4	12.0	13.4	14.7	17.0	19.0	23.2	33	20°	25°	28°
		ZLF25150	0.289	5.3	6.3	7.5	9.2	10.6	13.0	15.0	16.8	18.4	21	24	29	41	18°	25°	28°
	ZLF25200	0.333	7.1	8.4	10.0	12.2	14.1	17.3	20.0	22.4	24.5	28.3	32	39	55	19°	25°	27°	
	ZLF25400	0.471	14.1	16.7	20.0	24.5	28.3	34.6	40	45	49	57	63	77	110	19°	25°	27°	

CONTINUED on next page...

ZIP-TIP®

SPRAY ANGLE @ 40psi	ZF MODEL	ZLF MODEL	EQUIV. ORIFICE DIAMETER (inches)	CAPACITY (GPM) AT VARIOUS PRESSURES (psi)														SPRAY ANGLE @		
				5 psi	7 psi	10 psi	15 psi	20 psi	30 psi	40 psi	50 psi	60 psi	80 psi	100 psi	150 psi	300 psi	20 psi	40 psi	80 psi	
15°	ZF1505		.053	0.18	0.21	0.25	0.31	0.35	0.43	0.50	0.56	0.61	0.71	0.79	0.97	1.37	10°	15°	20°	
	ZF1506		.058	0.21	0.25	0.30	0.37	0.42	0.52	0.60	0.67	0.73	0.85	0.95	1.16	1.64	11°	15°	24°	
	ZF1508		.067	0.28	0.33	0.40	0.49	0.57	0.69	0.80	0.89	0.98	1.13	1.26	1.55	2.2	11°	15°	21°	
	ZF1510		.075	0.35	0.42	0.50	0.61	0.71	0.87	1.00	1.12	1.22	1.41	1.58	1.94	2.7	13°	15°	16°	
	ZF1515		.091	0.53	0.63	0.75	0.92	1.06	1.30	1.50	1.68	1.84	2.1	2.4	2.9	4.1	11°	15°	20°	
	ZF1520		.105	0.71	0.84	1.00	1.22	1.41	1.73	2.0	2.2	2.4	2.8	3.2	3.9	5.5	11°	15°	20°	
	ZF1530		.129	1.06	1.25	1.50	1.84	2.1	2.6	3.0	3.4	3.7	4.2	4.7	5.8	8.2	11°	15°	18°	
	ZF1540		.149	1.41	1.67	2.0	2.4	2.8	3.5	4.0	4.5	4.9	5.7	6.3	7.7	11.0	12°	15°	18°	
	ZF1550		.167	1.77	2.1	2.5	3.1	3.5	4.3	5.0	5.6	6.1	7.1	7.9	9.7	13.7	12°	15°	19°	
	ZF1560		.182	2.1	2.5	3.0	3.7	4.2	5.2	6.0	6.7	7.3	8.5	9.5	11.6	16.4	12°	15°	17°	
	ZF1570		.197	2.5	2.9	3.5	4.3	4.9	6.1	7.0	7.8	8.6	9.9	11.1	13.6	19.2	12°	15°	19°	
		ZLF1580		.211	2.83	3.3	4.0	4.9	5.7	6.9	8.0	8.9	9.8	11.3	12.6	15.5	21.9	12°	15°	19°
	ZLF15100		.236	3.5	4.2	5.0	6.1	7.1	8.7	10.0	11.2	12.2	14.1	15.8	19.4	27	12°	15°	19°	
	ZLF15120		.258	4.2	5.0	6.0	7.3	8.5	10.4	12.0	13.4	14.7	17.0	19.0	23	33	12°	15°	19°	
	ZLF15150		.289	5.3	6.3	7.5	9.2	10.6	13.0	15.0	16.8	18.4	21	24	29	41	12°	15°	18°	
	ZLF15200		.333	7.1	8.4	10.0	12.2	14.1	17.3	20	22	24	28	32	39	55	13°	15°	17°	
5°	ZF0505		.053	0.18	0.21	0.25	0.31	0.35	0.43	0.50	0.56	0.61	0.71	0.79	0.97	1.37	10°	15°	20°	
	ZF0506		.058	0.21	0.25	0.30	0.37	0.42	0.52	0.60	0.67	0.73	0.85	0.95	1.16	1.64	11°	15°	24°	
	ZF0508		.067	0.28	0.33	0.40	0.49	0.57	0.69	0.80	0.89	0.98	1.13	1.26	1.55	2.2	11°	15°	21°	
	ZF0510		.075	0.35	0.42	0.50	0.61	0.71	0.87	1.00	1.12	1.22	1.41	1.58	1.94	2.7	13°	15°	16°	
	ZF0515		.091	0.53	0.63	0.75	0.92	1.06	1.30	1.50	1.68	1.84	2.1	2.4	2.9	4.1	11°	15°	20°	
	ZF0520		.105	0.71	0.84	1.00	1.22	1.41	1.73	2.0	2.2	2.4	2.8	3.2	3.9	5.5	11°	15°	20°	
	ZF0530		.129	1.06	1.25	1.50	1.84	2.1	2.6	3.0	3.4	3.7	4.2	4.7	5.8	8.2	11°	15°	18°	
	ZF0540		.149	1.41	1.67	2.0	2.4	2.8	3.5	4.0	4.5	4.9	5.7	6.3	7.7	11.0	12°	15°	18°	

Solid stream spray nozzles



SPRAY ANGLE @ 40psi	ZF STYLE	ZLF STYLE	EQUIV. ORIFICE DIAMETER (inches)	CAPACITY (GPM) AT VARIOUS PRESSURES (psi)												SPRAY ANGLE @		
				5 psi	7 psi	10 psi	20 psi	30 psi	40 psi	60 psi	80 psi	100 psi	200 psi	300 psi	20 psi	40 psi	80 psi	
0°	ZF0002		.034	0.07	0.08	0.10	0.14	0.17	0.20	0.24	0.28	0.32	0.45	0.55	0° Solid Stream			
	ZF0003		.041	0.11	0.13	0.15	0.21	0.26	0.30	0.37	0.42	0.47	0.67	0.82				
	ZF0004		.047	0.14	0.17	0.20	0.28	0.35	0.40	0.49	0.57	0.63	0.89	1.10				
	ZF0005		.053	0.18	0.21	0.25	0.35	0.43	0.50	0.61	0.71	0.79	1.12	1.37				
	ZF0006		.058	0.21	0.25	0.30	0.42	0.52	0.60	0.73	0.85	0.95	1.34	1.64				
	ZF0008		.067	0.28	0.33	0.40	0.57	0.69	0.80	0.98	1.13	1.26	1.79	2.2				
	ZF0010		.075	0.35	0.42	0.50	0.71	0.87	1.00	1.22	1.41	1.58	2.2	2.7				
	ZF0015		.091	0.53	0.63	0.75	1.06	1.30	1.50	1.84	2.1	2.4	3.4	4.1				
	ZF0020		.105	0.71	0.84	1.00	1.41	1.73	2.0	2.4	2.8	3.2	4.5	5.5				
	ZF0030		.129	1.06	1.25	1.50	2.1	2.6	3.0	3.7	4.2	4.7	6.7	8.2				
	ZF0040		.149	1.41	1.67	2.0	2.8	3.5	4.0	4.9	5.7	6.3	8.9	11.0				
	ZF0050		.167	1.77	2.1	2.5	3.5	4.3	5.0	6.1	7.1	7.9	11.2	13.7				
	ZF0060		.182	2.1	2.5	3.0	4.2	5.2	6.0	7.3	8.5	9.5	13.4	16.4				
	ZF0070		.197	2.5	2.9	3.5	4.9	6.1	7.0	8.6	9.9	11.1	15.7	19.2				
		ZLF0080		.211	2.8	3.3	4.0	5.7	6.9	8.0	9.8	11.3	12.6	17.9		22		
		ZLF00100		.236	3.5	4.2	5.0	7.1	8.7	10.0	12.2	14.1	15.8	22		27		
	ZLF00120		.258	4.2	5.0	6.0	8.5	10.4	12.0	14.7	17.0	19.0	27	33				
	ZLF00150		.289	5.3	6.3	7.5	10.6	13.0	15.0	18.4	21	24	34	41				
	ZLF00200		.333	7.1	8.4	10.0	14.1	17.3	20.0	24.5	28.3	32	45	55				
	ZLF00400		.471	14.1	16.7	20.0	28.3	35	40	49	57	63	89	110				

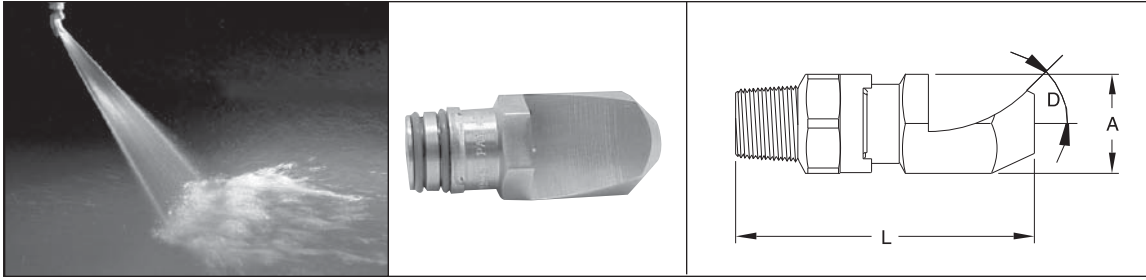

SPRAY CHARACTERISTICS:

A flat and thin fan-shaped spray with sharp definition on all edges. This spray delivers very high impact over the area covered. The spray is deflected by angle D away from the centerline of the spray nozzle.

CONSTRUCTION:

The models listed are machined from bar stock, and are one piece construction. Standard materials are brass, 303 stainless steel and 316 stainless steel.

TYPICAL APPLICATIONS:

- High Impact Applications
- Metal Wash
- Gravel Washing
- Vehicle Washing

SPRAY ANGLE @ 40psi	ZFP MODEL	ZLFP MODEL	ORIFICE DIA. (inches)	ANGLE 'D' @ 40psi	Dimensions (inches)		CAPACITY (GPM) AT VARIOUS PRESSURES (psi)										SPRAY ANGLE @		
					'A'	'L'	15 psi	20 psi	30 psi	40 psi	60 psi	80 psi	100 psi	150 psi	15 psi	40 psi	100 psi		
50°	ZFP5001		.024	40°	1.13	1.70	0.06	0.07	0.09	0.10	0.12	0.14	0.16	0.19	30°	50°	58°		
	ZFP50025		.038	41°	1.13	1.99	0.15	0.18	0.22	0.25	0.31	0.35	0.40	0.48	29°	50°	57°		
	ZFP5005		.053	41°	1.13	2.06	0.31	0.35	0.43	0.50	0.61	0.71	0.79	0.97	30°	50°	59°		
	ZFP5010		.075	52°	1.13	2.19	0.61	0.71	0.87	1.00	1.22	1.41	1.58	1.94	32°	50°	59°		
	ZFP5025		.118	40°	1.13	2.27	1.53	1.77	2.2	2.5	3.1	3.5	4.0	4.8	41°	50°	58°		
	ZFP5040		.149	45°	1.13	2.71	2.4	2.8	3.5	4.0	4.9	5.7	6.3	7.7	42°	50°	59°		
	ZFP5060		.183	40°	1.13	3.00	3.7	4.2	5.2	6.0	7.3	8.5	9.5	11.6	41°	50°	52°		
		ZLFP50100		.236	38°	1.44	3.96	6.1	7.1	8.7	10.0	12.2	14.1	15.8	19.4	44°	50°	54°	
		ZLFP50125		.266	34°	1.44	3.96	7.7	8.8	10.8	12.5	15.3	17.7	19.8	24	39°	50°	57°	
		ZLFP50160		.298	37°	1.44	3.96	9.8	11.3	13.9	16.0	19.6	23	25	31	46°	50°	55°	
	ZLFP50200		.328	33°	1.44	4.09	12.2	14.1	17.3	20	24	28	32	39	47°	50°	55°		
40°	ZFP4040		.149	34°	1.13	1.99	2.4	2.8	3.5	4.0	4.9	5.7	6.3	7.7	29°	40°	48°		
	ZFP4050		.167	32°	1.13	2.06	3.1	3.5	4.3	5.0	6.1	7.1	7.9	9.7	30°	40°	47°		
	ZFP4060		.183	31°	1.13	2.06	3.7	4.2	5.2	6.0	7.3	8.5	9.5	11.6	31°	40°	50°		
	ZFP4070		.197	28°	1.13	2.19	4.3	4.9	6.1	7.0	8.6	9.9	11.1	13.6	33°	40°	50°		
		ZLFP4080		.211	28°	1.44	2.51	4.9	5.7	6.9	8.0	9.8	11.3	12.6	15.5	33°	40°	48°	
		ZLFP4090		.228	28°	1.44	2.95	5.5	6.4	7.8	9.0	11.0	12.7	14.2	17.4	34°	40°	46°	
	ZLFP40100		.236	31°	1.44	3.24	6.1	7.1	8.7	10.0	12.2	14.1	15.8	19.4	34°	40°	46°		
35°	ZFP3504		.047	36°	1.13	2.21	0.24	0.28	0.35	0.40	0.49	0.57	0.63	0.77	20°	35°	41°		
	ZFP3510		.075	37°	1.13	2.35	0.61	0.71	0.87	1.00	1.22	1.41	1.58	1.94	18°	35°	38°		
	ZFP3520		.105	30°	1.13	2.48	1.22	1.41	1.73	2.0	2.4	2.8	3.2	3.9	25°	35°	42°		
	ZFP3525		.117	29°	1.13	2.57	1.53	1.77	2.2	2.5	3.1	3.5	4.0	4.8	24°	35°	41°		
	ZFP3530		.128	28°	1.13	2.68	1.84	2.1	2.6	3.0	3.7	4.2	4.7	5.8	25°	35°	42°		
	ZFP3540		.149	31°	1.13	2.90	2.4	2.8	3.5	4.0	4.9	5.7	6.3	7.7	29°	35°	42°		
	ZFP3550		.167	26°	1.13	3.18	3.1	3.5	4.3	5.0	6.1	7.1	7.9	9.7	30°	35°	40°		
	ZFP3560		.183	29°	1.13	3.32	3.7	4.2	5.2	6.0	7.3	8.5	9.5	11.6	27°	35°	40°		
		ZLFP3580		.211	22°	1.44	4.35	4.9	5.7	6.9	8.0	9.8	11.3	12.6	15.5	25°	35°	38°	
		ZLFP35100		.221	24°	1.44	4.67	6.1	7.1	8.7	10.0	12.2	14.1	15.8	19.4	25°	35°	40°	
	ZLFP35160		.295	22°	1.44	5.78	9.8	11.3	13.9	16.0	19.6	23	25	31	26°	35°	39°		
	ZLFP35200		.333	24°	1.44	5.97	12.2	14.1	17.3	20	24	28	32	39	31°	35°	42°		
25°	ZFP2540		.149	24°	1.13	3.38	2.4	2.8	3.5	4.0	4.9	5.7	6.3	7.7	22°	25°	27°		
15°	ZFP1510		.075	22°	1.13	2.93	0.61	0.71	0.87	1.00	1.22	1.41	1.58	1.94	--	15°	21°		
	ZFP1520		.105	16°	1.13	3.28	1.22	1.41	1.73	2.0	2.4	2.8	3.2	3.9	--	15°	18°		
	ZFP1530		.129	20°	1.13	3.85	1.84	2.1	2.6	3.0	3.7	4.2	4.7	5.8	8°	15°	24°		
	ZFP1540		.149	13°	1.13	4.21	2.4	2.8	3.5	4.0	4.9	5.7	6.3	7.7	8°	15°	20°		
	ZFP1550		.167	14°	1.13	4.58	3.1	3.5	4.3	5.0	6.1	7.1	7.9	9.7	8°	15°	22°		
	ZFP1560		.183	14°	1.13	5.87	3.7	4.2	5.2	6.0	7.3	8.5	9.5	11.6	11°	15°	18°		
		ZLFP1580		.218	14°	1.44	6.43	4.9	5.7	6.9	8.0	9.8	11.3	12.6	15.5	11°	15°	18°	
		ZLFP15100		.236	15°	1.44	6.74	6.1	7.1	8.7	10.0	12.2	14.1	15.8	19.4	11°	15°	17°	
	ZLFP15200		.333	15°	1.44	8.87	12.2	14.1	17.3	20	24	28	32	39	11°	15°	17°		
	ZLFP15300		0.408	15°	1.44	8.80	18.4	21	26	30	37	42	47	58	12°	15°	18°		

ZIP-TIP®

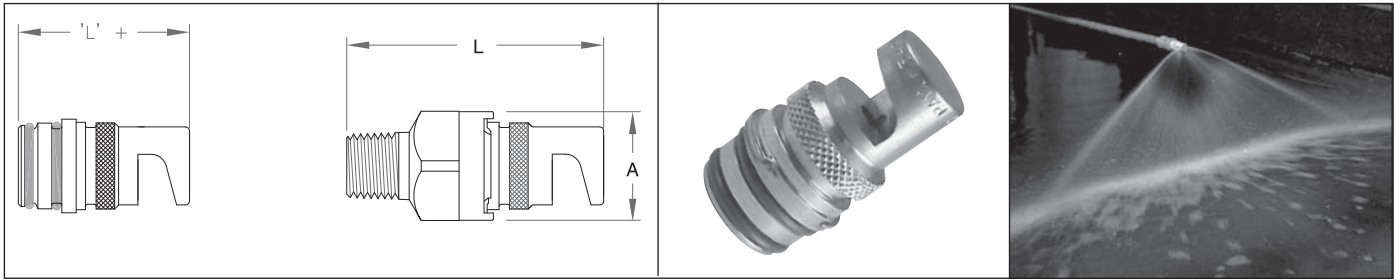

SPRAY CHARACTERISTICS:

A wide, flat fan-shaped spray with low impact. The spray is deflected 75° away from the centerline of the pipe connection, as shown.

CONSTRUCTION:

The tip models listed are machined from bar stock, and are one piece construction. Standard materials are brass, 303 stainless steel and 316 stainless steel. Some models may also be available in other materials.

TYPICAL APPLICATIONS:

Wherever a low impact, wide angle spray is required.

- Rinsing and Cooling
- Dishwashing
- Fertilizer Spraying
- Metal Wash

ZFL MODEL	ZFLT MODEL	ORIFICE DIA. (inches)	DIMENSIONS		CAPACITY (GPM) AT VARIOUS PRESSURES (psi)										SPRAY ANGLE @					
			"A"	"L"	3 psi	5 psi	7 psi	10 psi	15 psi	20 psi	30 psi	40 psi	60 psi	3 psi	5 psi	7 psi	10 psi	20 psi	60 psi	
	ZFLT.25	.017	.970	2.08	--	--	--	0.03	0.03	0.04	0.04	0.05	0.06	--	--	--	90°	106°	120°	
	ZFLT.50	.024	.970	2.08	--	--	0.04	0.05	0.06	0.07	0.09	0.10	0.12	--	--	65°	78°	99°	120°	
	ZFLT.75	.029	.970	2.08	--	--	0.06	0.08	0.09	0.11	0.13	0.15	0.18	--	--	72°	85°	112°	140°	
	ZFLT1	.033	.970	2.08	--	--	0.08	0.10	0.12	0.14	0.17	0.20	0.24	--	--	90°	97°	135°	148°	
	ZFLT1.3	.038	.970	2.08	--	0.09	0.11	0.13	0.16	0.18	0.23	0.26	0.32	--	73°	80°	92°	115°	134°	
	ZFL1.5	.042	.970	2.08	0.08	0.11	0.13	0.15	0.18	0.21	0.26	0.30	0.37	57°	69°	75°	87°	104°	125°	
	ZFLT2	.047	.970	2.08	0.11	0.14	0.17	0.20	0.24	0.28	0.35	0.40	0.49	60°	73°	82°	86°	104°	125°	
	ZFLT2.5	.055	.970	2.08	0.14	0.18	0.21	0.25	0.31	0.36	0.44	0.51	0.62	79°	87°	92°	101°	112°	130°	
	ZFLT3	.059	.970	2.08	0.16	0.21	0.25	0.30	0.37	0.42	0.52	0.60	0.73	84°	97°	106°	115°	130°	140°	
ZFL4		.070	.970	2.08	0.22	0.28	0.33	0.40	0.49	0.57	0.69	0.80	0.98	74°	87°	89°	101°	116°	127°	
ZFL5		.076	.970	2.18	0.27	0.35	0.42	0.50	0.61	0.71	0.87	1.00	1.22	78°	89°	97°	103°	113°	132°	
ZFL7.5		.094	.970	2.18	0.41	0.53	0.63	0.75	0.92	1.06	1.30	1.50	1.84	98°	105°	112°	120°	132°	144°	
ZFL10		.110	.970	2.18	0.55	0.71	0.84	1.00	1.22	1.41	1.73	2.0	2.4	116°	125°	135°	137°	144°	150°	
ZFL12		.120	.970	2.18	0.66	0.85	1.00	1.20	1.47	1.70	2.1	2.4	2.9	98°	105°	109°	118°	134°	139°	
ZFL15		.129	.970	2.18	0.82	1.06	1.25	1.50	1.84	2.1	2.6	3.0	3.7	100°	110°	115°	124°	131°	139°	
ZFL18		.147	.970	2.18	0.99	1.27	1.51	1.80	2.2	2.5	3.1	3.6	4.4	100°	112°	116°	124°	135°	137°	
ZFL20		.154	.970	2.18	1.10	1.41	1.67	2.0	2.4	2.8	3.5	4.0	4.9	115°	125°	128°	134°	142°	147°	
ZFL22		.161	.970	2.18	1.20	1.56	1.84	2.2	2.7	3.1	3.8	4.4	5.4	97°	108°	114°	120°	128°	132°	
ZFL24		.169	.970	2.18	1.31	1.70	2.0	2.4	2.9	3.4	4.2	4.8	5.9	106°	118°	121°	127°	136°	154°	
ZFL27		.177	.970	2.18	1.48	1.91	2.3	2.7	3.3	3.8	4.7	5.4	6.6	110°	120°	124°	129°	139°	146°	
ZFL30		.188	.970	2.18	1.64	2.1	2.5	3.0	3.7	4.2	5.2	6.0	7.3	104°	116°	121°	127°	135°	138°	
ZFL35		.196	.970	2.18	1.92	2.5	2.9	3.5	4.3	4.9	6.1	7.0	8.6	104°	114°	118°	126°	130°	137°	
ZFL40		.209	.970	2.18	2.19	2.8	3.3	4.0	4.9	5.7	6.9	8.0	9.8	104°	116°	121°	127°	135°	138°	
ZFL45		.228	.970	2.18	2.46	3.2	3.8	4.5	5.5	6.4	7.8	9.0	11.0	104°	114°	118°	126°	130°	137°	
ZFL60		.266	.970	2.18	3.29	4.2	5.0	6.0	7.3	8.5	10.4	12.0	14.7	110°	120°	124°	126°	130°	135°	

-- means not recommended at this pressure

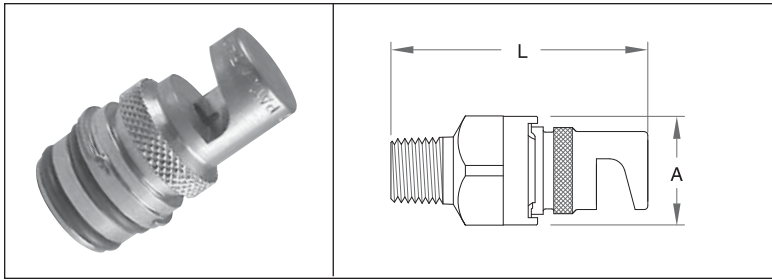

SPRAY CHARACTERISTICS:

The FL series spray nozzles may also be used with air or steam, resulting in a deflected curtain of gas extending no more than a few inches away from the nozzle. For most applications, the maximum practical target distance from the nozzle is 10 inches.

CONSTRUCTION:

The models listed are machined from bar stock, and are one piece construction. Standard materials are brass, 303 stainless steel and 316 stainless steel. Some models may also be available in other materials.

TYPICAL APPLICATIONS:

For dispensing air or steam. Stainless steel construction recommended for steam applications.

- Cleaning
- Cooling
- Blow-off of Surfaces

ZFL	ZFLT MODEL	ORIFICE DIA. (inches)	DIMENSIONS		AIR CAPACITY (SCFM)					COVERAGE AT 6" DISTANCE FROM THE NOZZLE (inches)	
			"A"	"L"	10 psi	20 psi	40 psi	50 psi	80 psi	10 psi	15 psi
	ZFLT.25	.017	.970	2.08	0.06	0.14	0.22	0.26	0.38	2	4 1/2
	ZFLT.50	.024	.970	2.08	0.11	0.27	0.43	0.50	0.74	2	5
	ZFLT.75	.029	.970	2.08	0.17	0.39	0.61	0.73	1.06	2 1/2	6
	ZFLT1	.033	.970	2.08	0.22	0.51	0.80	0.95	1.39	3	6
	ZFLT1.3	.038	.970	2.08	0.29	0.68	1.07	1.27	1.86	3	6 1/2
	ZFLT1.5	.042	.970	2.08	0.35	0.83	1.31	1.55	2.3	3 1/2	6 1/2
	ZFLT2	.047	.970	2.08	0.44	1.03	1.62	1.92	2.8	3 1/2	7 1/2
	ZFLT2.5	.055	.970	2.08	0.60	1.42	2.2	2.6	3.9	4	7 1/2
	ZFLT3	.059	.970	2.08	0.69	1.63	2.6	3.0	4.4	5	8
ZFL4		.070	.970	2.08	0.98	2.3	3.6	4.3	6.3	5	9
ZFL5		.076	.970	2.18	1.15	2.7	4.3	5.0	7.4	6	10
ZFL7.5		.094	.970	2.18	1.76	4.2	6.6	7.8	11.5	6 1/2	10
ZFL10		.110	.970	2.18	2.40	5.7	9.0	10.6	15.6	7	11
ZFL12		.120	.970	2.18	2.90	6.8	10.7	12.7	18.6	7	11 1/2
ZFL15		.129	.970	2.18	3.50	8.4	13.2	15.7	23	7	12
ZFL18		.147	.970	2.18	4.30	10.3	16.2	19.2	28	8	13
ZFL20		.154	.970	2.18	4.70	11.3	17.8	21	31	8 1/2	14 1/2
ZFL22		.161	.970	2.18	5.2	12.3	19.4	23	34	8 1/2	14 1/2
ZFL24		.169	.970	2.18	5.7	13.6	21	25	37	8 1/2	15
ZFL27		.177	.970	2.18	6.3	14.9	23	28	41	8 1/2	15
ZFL30		.188	.970	2.18	7.1	16.8	26	31	46	8 1/2	15 1/2

Full cone spray nozzles

ZS Series

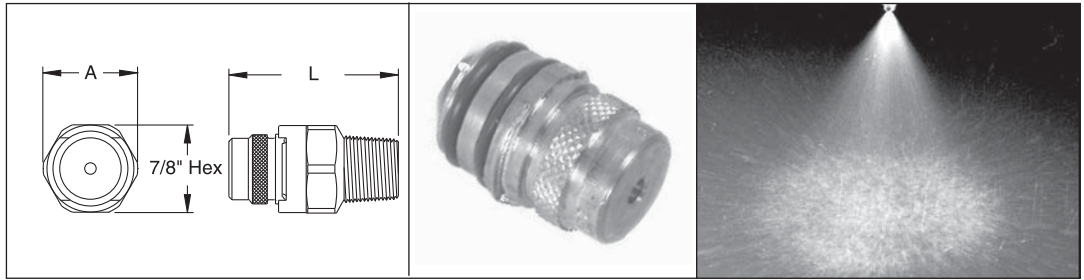

SPRAY CHARACTERISTICS:

Full cone spray pattern, with uniform distribution throughout the cone.

CONSTRUCTION:

The nozzle contains a patented insert with larger flow passages than older styles, and is less susceptible to clogging. Standard materials are brass, 303 stainless steel and 316 stainless steel.

TYPICAL APPLICATIONS:

- Chemical Processing
- Cooling Sprays
- Foam Breaking
- Continuous Casting

U.S. Patent No. 4,142,682

Canadian Patent No. 1,050,589

ZS SERIES

One piece body + removable insert



DIMENSIONS

MODEL	DIM "L"	DIM "A"
1/8ZS	1.60	0.97
1/4ZS	1.70	0.97
3/8ZS	1.73	0.97
1/2ZS	1.80	0.97
3/8ZLS	2.11	1.25
1/2ZLS	2.19	1.25

ZGS SERIES

Two piece body + removable insert



DIMENSIONS

MODEL	DIM "L"	DIM "A"
1/8ZGS	1.98	0.97
1/4ZGS	2.12	0.97
3/8ZGS	2.56	0.97
1/2ZGS	2.63	0.97
3/8ZLGS	2.79	1.25
1/2ZLGS	2.87	1.25

ZHGS SERIES

Two piece body + removable insert

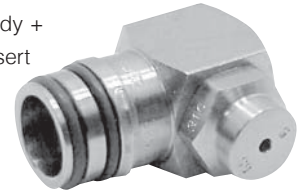

DIMENSIONS

MODEL	DIM "L"	DIM "A"
1/8ZHGS	2.11	1.48
1/4ZHGS	2.21	1.60
3/8ZHGS	2.24	1.65
1/2ZHGS	2.31	1.80
3/8ZLHGS	2.96	1.71
1/2ZLHGS	3.04	1.86

ZIP-TIP®

'ZS' one piece tip	'ZGS' two piece tip		'ZHGS' Right Angle two piece tip		MAXIMUM FREE PASSAGE (inches)	CAPACITY (GPM) AT VARIOUS PRESSURES (psi)												Spray Angle @			
	ZGS	ZLGS	ZHGS	ZLHGS		3 psi	5 psi	7 psi	10 psi	15 psi	20 psi	30 psi	40 psi	60 psi	80 psi	100 psi	150 psi	7 psi	20 psi	80 psi	
ZS1	ZGS1		ZHGS1		.033	--	--	--	--	0.12	0.14	0.17	0.20	0.24	0.28	0.32	0.39	--	55°	52°	
ZS1.5	ZGS1.5		ZHGS1.5		.046	--	--	--	0.15	0.18	0.21	0.26	0.30	0.37	0.42	0.47	0.58	--	65°	57°	
ZS2	ZGS2		ZHGS2		.051	--	--	0.17	0.20	0.24	0.28	0.35	0.40	0.49	0.57	0.63	0.77	54°	59°	60°	
ZS3	ZGS3		ZHGS3		.051	--	0.21	0.25	0.30	0.37	0.42	0.52	0.60	0.73	0.85	0.95	1.16	50°	53°	60°	
ZS3.5	ZGS3.5		ZHGS3.5		.051	0.19	0.25	0.29	0.35	0.43	0.49	0.61	0.70	0.86	0.99	1.11	1.36	48°	58°	61°	
ZS5	ZGS5		ZHGS5		.064	0.27	0.35	0.42	0.50	0.61	0.71	0.87	1.00	1.22	1.41	1.58	1.94	60°	75°	70°	
ZS6	ZGS6		ZHGS6		.064	0.33	0.42	0.50	0.60	0.73	0.85	1.04	1.20	1.47	1.70	1.90	2.3	67°	72°	70°	
ZS6.5	ZGS6.5		ZHGS6.5		.091	0.36	0.46	0.54	0.65	0.80	0.92	1.13	1.30	1.59	1.84	2.1	2.5	48°	56°	50°	
ZS7.5	ZGS7.5		ZHGS7.5		.091	0.41	0.53	0.63	0.75	0.92	1.06	1.30	1.50	1.84	2.1	2.4	2.9	55°	65°	48°	
ZS8.5	ZGS8.5		ZHGS8.5		.091	0.47	0.60	0.71	0.85	1.04	1.20	1.47	1.70	2.1	2.4	2.7	3.3	58°	65°	63°	
ZS10	ZGS10		ZHGS10		.091	0.55	0.71	0.84	1.00	1.22	1.41	1.73	2.0	2.4	2.8	3.2	3.9	60°	65°	62°	
ZS14	ZGS14		ZHGS14		.091	0.77	0.99	1.17	1.40	1.71	1.98	2.4	2.8	3.4	4.0	4.4	5.4	78°	85°	75°	
ZS15	ZGS15		ZHGS15		.102	0.82	1.06	1.25	1.50	1.84	2.1	2.6	3.0	3.7	4.2	4.7	5.8	63°	65°	60°	
ZS18	ZGS18		ZHGS18		.102	0.99	1.27	1.51	1.80	2.2	2.5	3.1	3.6	4.4	5.1	5.7	7.0	85°	88°	76°	
ZS20	ZGS20		ZHGS20		.102	1.10	1.41	1.67	2.0	2.4	2.8	3.5	4.0	4.9	5.7	6.3	7.7	76°	82°	75°	
ZS22	ZGS22		ZHGS22		.114	1.20	1.56	1.84	2.2	2.7	3.1	3.8	4.4	5.4	6.2	7.0	8.5	76°	78°	76°	
	ZLS16		ZLGS16		ZLHGS16	.144	0.88	1.13	1.34	1.60	1.96	2.3	2.8	3.2	3.9	4.5	5.1	6.2	55°	60°	55°
	ZLS25		ZLGS25		ZLHGS25	.144	1.37	1.77	2.1	2.5	3.1	3.5	4.3	5.0	6.1	7.1	7.9	9.7	68°	73°	65°
	ZLS32		ZLGS32		ZLHGS32	.144	1.75	2.3	2.7	3.2	3.9	4.5	5.5	6.4	7.8	9.1	10.1	12.4	80°	90°	75°
	ZLS40		ZLGS40		ZLHGS40	.162	2.2	2.8	3.3	4.0	4.9	5.7	6.9	8.0	9.8	11.3	12.6	15.5	86°	90°	81°

ZSW Series

Wide angle full cone spray nozzles

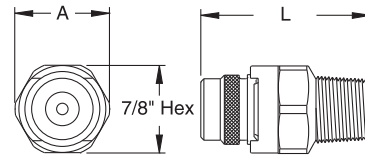
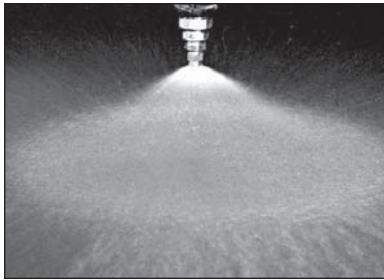

TYPICAL APPLICATIONS:

Anywhere a wide angle full cone spray is required:

- Chemical Processing
- Cooling Sprays
- Continuous Casting

SPRAY CHARACTERISTICS:

A wide angle full cone spray pattern, with uniform distribution throughout the cone.

CONSTRUCTION:

This nozzle tip contains a patented insert with larger flow passages than older styles, and is less susceptible to clogging. Standard materials are brass, 303 stainless steel and 316 stainless steel.

U.S. Patent No. 4,142,682

Canadian Patent No. 1,050,589

ZSW SERIES

One piece body + removable insert



DIMENSIONS

MODEL	DIM "L"	DIM "A"
1/8ZSW	1.60	0.97
1/4ZSW	1.70	0.97
3/8ZSW	1.73	0.97
1/2ZSW	1.80	0.97
3/8ZLSW	2.11	1.25
1/2ZLSW	2.19	1.25

ZGSW SERIES

Two piece body + removable insert



DIMENSIONS

MODEL	DIM "L"	DIM "A"
1/8ZGSW	1.98	0.97
1/4ZGSW	2.12	0.97
3/8ZGSW	2.56	0.97
1/2ZGSW	2.63	0.97
3/8ZLGSW	2.79	1.25
1/2ZLGSW	2.87	1.25

ZHGSW SERIES

Two piece body + removable insert

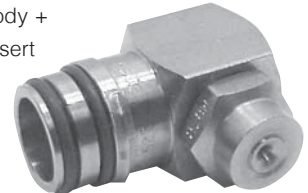

DIMENSIONS

MODEL	DIM "L"	DIM "A"
1/8ZHGSW	2.11	1.48
1/4ZHGSW	2.21	1.60
3/8ZHGSW	2.24	1.65
1/2ZHGSW	2.31	1.80
3/8ZLHGSW	2.96	1.71
1/2ZLHGSW	3.04	1.86

ZIP-TIP®

'ZSW' one piece tip	'ZGSW' two piece tip		'ZHGSW' Right Angle two piece tip		MAXIMUM FREE PASSAGE (inches)	CAPACITY (GPM) AT VARIOUS PRESSURES (psi)												Spray Angle @		
	ZGSW	ZLGSW	ZHGSW	ZLHGSW		5 psi	7 psi	10 psi	15 psi	20 psi	30 psi	40 psi	60 psi	80 psi	100 psi	150 psi	7 psi	20 psi	80 psi	
ZS2.8W	ZGS2.8W		ZHGS2.8W		.051	--	0.23	0.28	0.34	0.40	0.48	0.56	0.69	0.79	0.89	1.08	110°	105°	96°	
ZS4.3W	ZGS4.3W		ZHGS4.3W		.051	--	0.36	0.43	0.53	0.61	0.74	0.86	1.05	1.22	1.36	1.67	117°	108°	100°	
ZS5.6W	ZGS5.6W		ZHGS5.6W		.064	--	0.47	0.56	0.69	0.79	0.97	1.12	1.37	1.58	1.77	2.2	117°	110°	100°	
ZS8W	ZGS8W		ZHGS8W		.081	0.57	0.67	0.80	0.98	1.13	1.39	1.60	1.96	2.3	2.5	3.1	118°	110°	103°	
ZS10W	ZGS10W		ZHGS10W		.091	0.71	0.84	1.00	1.22	1.41	1.73	2.0	2.4	2.8	3.2	3.9	118°	108°	102°	
ZS12W	ZGS12W		ZHGS12W		.091	0.85	1.00	1.20	1.47	1.70	2.1	2.4	2.9	3.4	3.8	4.6	120°	112°	102°	
ZS14W	ZGS14W		ZHGS14W		.091	0.99	1.17	1.40	1.71	1.98	2.4	2.8	3.4	4.0	4.4	5.4	118°	114°	104°	
ZS17W	ZGS17W		ZHGS17W		.102	1.20	1.42	1.70	2.1	2.4	2.9	3.4	4.2	4.8	5.4	6.6	118°	117°	102°	
ZS20W	ZGS20W		ZHGS20W		.102	1.41	1.67	2.0	2.4	2.8	3.5	4.0	4.9	5.7	6.3	7.7	120°	120°	106°	
ZS24W	ZGS24W		ZHGS24W		.102	1.70	2.0	2.4	2.9	3.4	4.2	4.8	5.9	6.8	7.6	9.3	122°	118°	106°	
ZS27W	ZGS27W		ZHGS27W		.102	1.91	2.3	2.7	3.3	3.8	4.7	5.4	6.6	7.6	8.5	10.5	122°	120°	107°	
	ZLS30W	ZLGS30W		ZLHGS30W	.144	2.1	2.5	3.0	3.7	4.2	5.2	6.0	7.3	8.5	9.5	11.6	120°	118°	110°	
	ZLS35W	ZLGS35W		ZLHGS35W	.144	2.5	2.9	3.5	4.3	4.9	6.1	7.0	8.6	9.9	11.1	13.6	122°	118°	108°	
	ZLS40W	ZLGS40W		ZLHGS40W	.162	2.8	3.3	4.0	4.9	5.7	6.9	8.0	9.8	11.3	12.6	15.5	122°	119°	104°	
	ZLS45W	ZLGS45W		ZLHGS45W	.162	3.2	3.8	4.5	5.5	6.4	7.8	9.0	11.0	12.7	14.2	17.4	141°	118°	108°	

Full square spray nozzles

ZSQ Series



SPRAY CHARACTERISTICS:

Full cone spray pattern, with uniform distribution throughout the approximately square cone.

CONSTRUCTION:

Standard materials are brass, 303 and 316 stainless.

TYPICAL APPLICATIONS:

- Chemical Processing
- Cooling Sprays
- Continuous Casting

U.S. Patent No. 4,142,682

Canadian Patent No. 1,050,589

ZSQ SERIES

One piece body + removable insert



DIMENSIONS

MODEL	DIM "L"	DIM "A"
1/8ZSQ	1.60	0.97
1/4ZSQ	1.70	0.97
3/8ZSQ	1.73	0.97
1/2ZSQ	1.80	0.97
3/8ZLSQ	2.11	1.25
1/2ZLSQ	2.19	1.25

ZGSQ SERIES

Two piece body + removable insert



DIMENSIONS

MODEL	DIM "L"	DIM "A"
1/8ZGSQ	1.98	0.97
1/4ZGSQ	2.12	0.97
3/8ZGSQ	2.56	0.97
1/2ZGSQ	2.63	0.97
3/8ZLGSQ	2.79	1.25
1/2ZLGSQ	2.87	1.25

FSQ: Female Connection SQ: Male Connection

FSQ: Female Connection SQ: Male Connection

ZIP-TIP®

'ZSQ' one piece tip	'ZGSQ' two piece tip		'ZHGSQ' Right Angle two piece tip		MAXIMUM FREE PASSAGE (inches)	CAPACITY (GPM) AT VARIOUS PRESSURES (psi)											Spray Angle @		
	ZGSQ	ZLGSQ	ZHGSQ	ZLHGSQ		5 psi	7 psi	10 psi	15 psi	20 psi	30 psi	40 psi	60 psi	80 psi	100 psi	150 psi	7 psi	20 psi	80 psi
ZS3.6SQ	ZGS3.6SQ		ZHGS3.6SQ		.057	--	0.30	0.36	0.44	0.51	0.62	0.72	0.88	1.02	1.14	1.39	42°	55°	50°
ZS4.8SQ	ZGS4.8SQ		ZHGS4.8SQ		.064	--	0.40	0.48	0.59	0.68	0.83	0.96	1.18	1.36	1.52	1.86	50°	65°	60°
ZS6SQ	ZGS6SQ		ZHGS6SQ		.081	--	0.50	0.60	0.73	0.85	1.04	1.20	1.47	1.70	1.90	2.3	30°	65°	60°
ZS10SQ	ZGS10SQ		ZHGS10SQ		.091	0.71	0.84	1.00	1.22	1.41	1.73	2.0	2.4	2.8	3.2	3.9	61°	67°	60°
ZS12SQ	ZGS12SQ		ZHGS12SQ		.091	0.85	1.00	1.20	1.47	1.70	2.1	2.4	2.9	3.4	3.8	4.6	71°	76°	69°
ZS14SQ	ZGS14SQ		ZHGS14SQ		.091	0.99	1.17	1.40	1.71	1.98	2.4	2.8	3.4	4.0	4.4	5.4	78°	85°	75°
ZS18SQ	ZGS18SQ		ZHGS18SQ		.102	1.27	1.51	1.80	2.2	2.5	3.1	3.6	4.4	5.1	5.7	7.0	70°	75°	68°
	ZLS29SQ	ZLGS29SQ	ZLHGS29SQ		.144	2.1	2.4	2.9	3.6	4.1	5.0	5.8	7.1	8.2	9.2	11.2	70°	75°	68°
	ZLS36SQ	ZLGS36SQ	ZLHGS36SQ		.144	2.5	3.0	3.6	4.4	5.1	6.2	7.2	8.8	10.2	11.4	13.9	80°	85°	77°

ZSWSQ Series

Wide angle full square spray nozzles

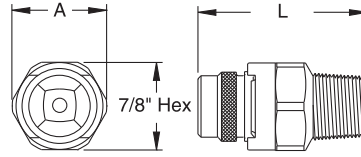

DIMENSIONS

MODEL	DIM "L"	DIM "A"
1/8ZSWSQ	1.60	0.97
1/4ZSWSQ	1.70	0.97
3/8ZSWSQ	1.73	0.97
1/2ZSWSQ	1.80	0.97
3/8ZLSWSQ	2.11	1.25
1/2ZLSWSQ	2.19	1.25

'ZSWSQ' one piece tip	MAXIMUM FREE PASSAGE (inches)	CAPACITY (GPM) AT VARIOUS PRESSURES (psi)												Spray Angle @		
		5 psi	7 psi	10 psi	15 psi	20 psi	30 psi	40 psi	60 psi	80 psi	100 psi	150 psi	7 psi	20 psi	80 psi	
ZSWSQ	ZLSWSQ	.091	0.99	1.17	1.40	1.71	1.98	2.4	2.8	3.4	4.0	4.4	5.4	102°	98°	84°
ZS14WSQ		.102	1.20	1.42	1.70	2.1	2.4	2.9	3.4	4.2	4.8	5.4	6.6	50°	94°	82°
ZS17WSQ		.102	1.41	1.67	2.0	2.4	2.8	3.5	4.0	4.9	5.7	6.3	7.7	60°	102°	86°
ZS20WSQ		.102	1.70	2.0	2.4	2.9	3.4	4.2	4.8	5.9	6.8	7.6	9.3	104°	102°	86°
ZS24WSQ		.102	1.91	2.3	2.7	3.3	3.8	4.7	5.4	6.6	7.6	8.5	10.5	104°	102°	87°
ZS27WSQ		.144	2.1	2.5	3.0	3.7	4.2	5.2	6.0	7.3	8.5	9.5	11.6	100°	96°	85°
ZLS30WSQ		.144	2.5	2.9	3.5	4.3	4.9	6.1	7.0	8.6	9.9	11.1	13.6	104°	99°	88°
ZLS35WSQ		.162	2.8	3.3	4.0	4.9	5.7	6.9	8.0	9.8	11.3	12.6	15.5	106°	104°	90°
ZLS40WSQ		.162	3.2	3.8	4.5	5.5	6.4	7.8	9.0	11.0	12.7	14.2	17.4	106°	104°	94°
ZLS45WSQ		.195	3.5	4.2	5.0	6.1	7.1	8.7	10.0	12.2	14.1	15.8	19.4	108°	102°	97°

ZHNS Series

Vaneless full cone spray nozzles

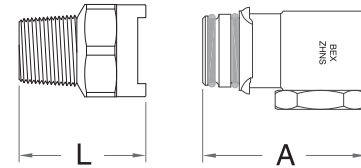
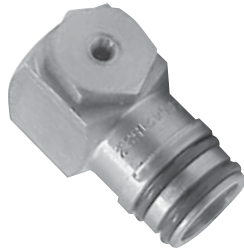
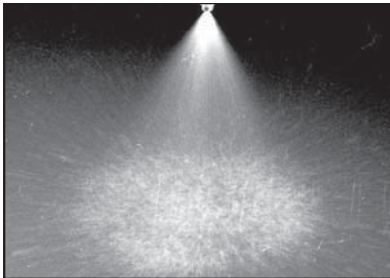

DIMENSIONS

MODEL	DIM "L"	DIM "A"
1/8ZHNS	2.11	1.32
1/4ZHNS	2.21	1.32
3/8ZHNS	2.24	1.32
1/2ZHNS	2.31	1.32

MODEL NUMBER		MAXIMUM FREE PASSAGE (inches)	CAPACITY (GPM) AT VARIOUS PRESSURES (psi)												Spray Angle (deg.)		
ZHNS	ZLHNS		5 psi	7 psi	10 psi	15 psi	20 psi	30 psi	40 psi	60 psi	80 psi	100 psi	125 psi	10 psi	20 psi	40 psi	
ZHNS5		.078	0.35	0.42	0.50	0.61	0.71	0.87	1.00	1.22	1.41	1.58	1.77	60	75	85	
ZHNS7		.094	0.49	0.59	0.70	0.86	0.99	1.21	1.40	1.71	1.98	2.2	2.5	60	76	90	
ZHNS8		.109	0.57	0.67	0.80	0.98	1.13	1.39	1.60	1.96	2.3	2.5	2.8	63	76	85	
ZHNS10		.125	0.71	0.84	1.00	1.22	1.41	1.73	2.0	2.4	2.8	3.2	3.5	63	79	84	
ZHNS11		.141	0.78	0.92	1.1	1.35	1.56	1.91	2.2	2.7	3.1	3.5	3.9	70	83	86	
ZHNS11		.125	0.78	0.92	1.1	1.35	1.56	1.91	2.2	2.7	3.1	3.5	3.9	80	91	95	
ZHNS13		.141	0.92	1.09	1.3	1.59	1.84	2.3	2.6	3.2	3.7	4.1	4.6	75	81	93	
ZHNS16		.156	1.13	1.34	1.6	1.96	2.3	2.8	3.2	3.9	4.5	5.1	5.7	79	82	86	
ZHNS20		.172	1.41	1.67	2.0	2.4	2.8	3.5	4.0	4.9	5.7	6.3	7.1	77	80	87	
ZHNS23		.188	1.63	1.92	2.3	2.8	3.3	4.0	4.6	5.6	6.5	7.3	8.1	79	70	91	
ZHNS26		.203	1.84	2.2	2.6	3.2	3.7	4.5	5.2	6.4	7.4	8.2	9.2	82	86	93	
ZHNS29		.219	2.1	2.4	2.9	3.6	4.1	5.0	5.8	7.1	8.2	9.2	10.3	86	90	96	
ZHNS33		.234	2.3	2.8	3.3	4.0	4.7	5.7	6.6	8.1	9.3	10.4	11.7	87	90	95	
	ZLHNS32	.203	2.3	2.7	3.2	3.9	4.5	5.5	6.4	7.8	9.1	10.1	11.3	70	87	94	
	ZLHNS40	.234	2.8	3.3	4.0	4.9	5.7	6.9	8.0	9.8	11.3	12.6	14.1	84	90	96	
	ZLHNS48	.281	3.4	4.0	4.8	5.9	6.8	8.3	9.6	11.8	13.6	15.2	17.0	87	93	96	
	ZLHNS56	.297	4.0	4.7	5.6	6.9	7.9	9.7	11.2	13.7	15.8	17.7	19.8	91	94	96	
	ZLHNS64	.328	4.5	5.4	6.4	7.8	9.1	11.1	12.8	15.7	18.1	20	23	86	90	94	
	ZLHNS72	.359	5.1	6.0	7.2	8.8	10.2	12.5	14.4	17.6	20	23	25	89	93	96	

Hollow cone spray nozzles

ZH Series

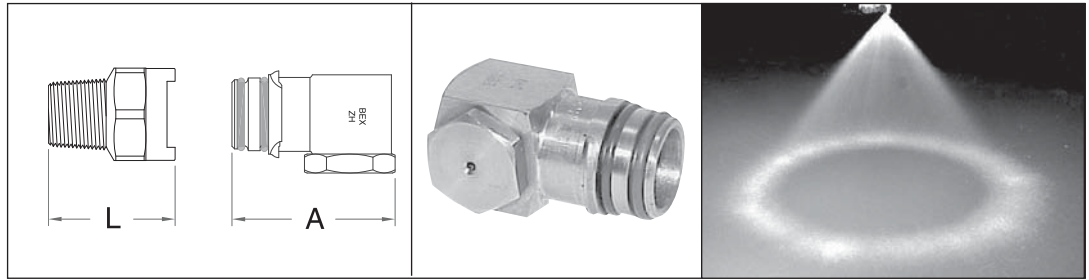

DIMENSIONS

MODEL	DIM "L"	DIM "A"
1/8ZH	2.11	1.32
1/4ZH	2.21	1.32
3/8ZH	2.24	1.32
1/2ZH	2.31	1.32

SPRAY CHARACTERISTICS:

A hollow cone spray pattern, emerging at right angles to the centerline of the pipe connection. The standard included angle of the spray cone is 70° at 10 p.s.i. At low pressures hollow cone nozzles produce medium size, uniform droplets. At higher pressures finer droplets are produced.

CONSTRUCTION:

The models listed are machined from bar stock, and are two piece construction. Standard materials are brass, 303 stainless steel and 316 stainless steel. Some models available in other materials.

TYPICAL APPLICATIONS:

- Air and Gas Washing
- Aerating, Rinsing and Humidifying
- Industrial Washers and Spray Ponds
- Cooling Tunnels
- Roof Cooling
- Degreasing
- Dust Suppression
- Metal Treatment

MODEL NUMBER		MAXIMUM FREE PASSAGE (inches)	CAPACITY (GPM) AT VARIOUS PRESSURES (psi)											SPRAY ANGLE @			
ZH	ZLH		3 psi	5 psi	7 psi	10 psi	15 psi	20 psi	30 psi	40 psi	60 psi	80 psi	100 psi	10 psi	20 psi	40 psi	80 psi
ZH0.5		.028	--	--	--	--	--	--	0.09	0.10	0.12	0.14	0.16	--	--	40°	45°
ZH1		.060	--	--	--	0.10	0.12	0.14	0.17	0.20	0.24	0.28	0.32	--	61°	74°	69°
ZH2		.085	--	--	--	0.20	0.24	0.28	0.35	0.40	0.49	0.57	0.63	70°	75°	83°	85°
ZH3		.111	--	--	0.25	0.30	0.37	0.42	0.52	0.60	0.73	0.85	0.95	70°	70°	72°	74°
ZH5		.136	--	0.35	0.42	0.50	0.61	0.71	0.87	1.00	1.22	1.41	1.58	70°	77°	80°	83°
ZH7.5		.166	0.41	0.53	0.63	0.75	0.92	1.06	1.30	1.50	1.84	2.1	2.4	70°	70°	74°	75°
ZH10		.170	0.55	0.71	0.84	1.00	1.22	1.41	1.73	2.0	2.4	2.8	3.2	70°	74°	76°	80°
ZH12.5		.177	0.68	0.88	1.05	1.25	1.53	1.77	2.17	2.5	3.1	3.5	4.0	70°	82°	83°	83°
ZH15		.213	0.82	1.06	1.25	1.50	1.84	2.1	2.60	3.0	3.7	4.2	4.7	70°	73°	75°	75°
ZH20		.250	1.10	1.41	1.67	2.0	2.45	2.8	3.46	4.0	4.9	5.7	6.3	70°	73°	75°	75°
ZH25		.279	1.37	1.77	2.1	2.5	3.06	3.5	4.33	5.0	6.1	7.1	7.9	70°	72°	73°	73°
ZH30		.292	1.64	2.1	2.5	3.0	3.67	4.2	5.20	6.0	7.3	8.5	9.5	70°	70°	73°	72°
	ZLH40	.369	2.2	2.8	3.3	4.0	4.90	5.7	6.93	8.0	9.8	11.3	12.6	70°	75°	75°	75°
	ZLH50	.393	2.7	3.5	4.2	5.0	6.12	7.1	8.66	10.0	12.2	14.1	15.8	70°	70°	71°	73°
	ZLH60	.421	3.3	4.2	5.0	6.0	7.35	8.5	10.39	12.0	14.7	17.0	19.0	70°	70°	71°	71°
	ZLH70	.469	3.8	4.9	5.9	7.0	8.57	9.9	12.12	14.0	17.1	19.8	22.1	70°	74°	76°	76°
	ZLH80	.484	4.4	5.7	6.7	8.0	9.80	11.3	13.86	16.0	19.6	23	25	70°	73°	75°	76°
	ZLH90	.500	4.9	6.4	7.5	9.0	11.02	12.7	15.59	18.0	22	25	28	70°	70°	71°	73°
	ZLH100	.507	5.5	7.1	8.4	10.0	12.25	14.1	17.32	20	24	28	32	70°	73°	76°	78°
	ZLH110	.575	6.0	7.8	9.2	11.0	13.47	15.6	19.05	22	27	31	35	70°	72°	75°	72°
	ZLH120	.568	6.6	8.5	10.0	12.0	14.70	17.0	20.78	24	29	34	38	70°	70°	71°	71°

"--" means not recommended at this pressure.

ZIP-TIP®

ZHW Series

Wide angle hollow cone spray nozzles

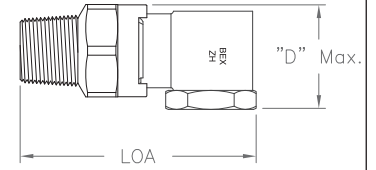
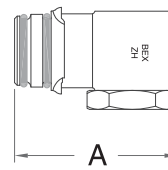
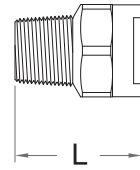
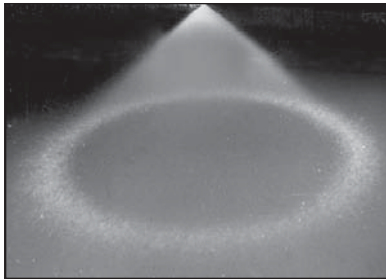

DIMENSIONS

MODEL	DIM "L"	DIM "A"
1/8ZHW	2.11	1.32
1/4ZHW	2.21	1.32
3/8ZHW	2.24	1.32
1/2ZHW	2.31	1.32

TYPICAL APPLICATIONS:

- Water Cooling
- Roof Cooling
- Air Cooling
- Air Washing

SPRAY CHARACTERISTICS:

A hollow cone spray pattern, similar to the BEX H series, but with wider spray angles. The included angle of the spray cone is 120° at 10 p.s.i.

CONSTRUCTION:

The models listed are machined from bar stock, and are two piece construction. Standard materials are brass, 303 stainless steel and 316 stainless steel. Some models are also available in other materials.

MODEL NUMBER		MAXIMUM FREE PASSAGE (inches)	CAPACITY (GPM) AT VARIOUS PRESSURE (psi)												SPRAY ANGLE @			
ZHW	ZLHW		5 psi	7 psi	10 psi	15 psi	20 psi	30 psi	40 psi	60 psi	80 psi	100 psi	125 psi	10 psi	20 psi	40 psi	80 psi	
ZH1W		.055	--	0.08	0.10	0.12	0.14	0.17	0.20	0.24	0.28	0.32	0.35	120°	110°	102°	90°	
ZH2W		.077	--	0.17	0.20	0.24	0.28	0.35	0.40	0.49	0.57	0.63	0.71	120°	110°	105°	92°	
ZH3W		.093	--	0.25	0.30	0.37	0.42	0.52	0.60	0.73	0.85	0.95	1.06	120°	114°	104°	90°	
ZH5W		.109	--	0.42	0.50	0.61	0.71	0.87	1.00	1.22	1.41	1.58	1.77	120°	113°	107°	98°	
ZH7.5W		.158	0.53	0.63	0.75	0.92	1.06	1.30	1.50	1.8	2.1	2.4	2.7	120°	115°	110°	92°	
ZH10W		.170	0.71	0.84	1.00	1.22	1.41	1.73	2.0	2.4	2.8	3.2	3.5	120°	115°	110°	93°	
ZH12.5W		.188	0.88	1.05	1.25	1.53	1.77	2.2	2.5	3.1	3.5	4.0	4.4	120°	118°	110°	94°	
ZH15W		.201	1.06	1.25	1.50	1.84	2.1	2.6	3.0	3.7	4.2	4.7	5.3	120°	115°	108°	92°	
ZH20W		.234	1.41	1.67	2.0	2.4	2.8	3.5	4.0	4.9	5.7	6.3	7.1	120°	118°	116°	110°	
ZH25W		.265	1.77	2.1	2.5	3.1	3.5	4.3	5.0	6.1	7.1	7.9	8.8	120°	117°	115°	110°	
ZH30W		.280	2.1	2.5	3.0	3.7	4.2	5.2	6.0	7.3	8.5	9.5	10.6	120°	115°	110°	102°	
	ZLH50W	.358	3.5	4.2	5.0	6.1	7.1	8.7	10.0	12.2	14.1	15.8	17.7	120°	115°	108°	103°	
	ZLH80W	.468	5.7	6.7	8.0	9.8	11.3	13.9	16.0	20	23	25	28	120°	117°	110°	103°	

ZPH SERIES

Hollow cone phosphating nozzles

SPRAY CHARACTERISTICS:

A hollow cone spray pattern for phosphating applications. This large droplet, low impingement type of spray results in a tighter and more consistent phosphate crystalline structure.

CONSTRUCTION:

Two piece construction. Available in 303 stainless steel and 316 stainless steel.



MODEL NUMBER	ORIFICE DIAMETER (inches)		CAPACITY (GPM) AT VARIOUS PRESSURES (psi)											SPRAY ANGLE @		
	BODY	CAP	5 psi	7 psi	10 psi	15 psi	20 psi	30 psi	40 psi	60 psi	80 psi	100 psi	10 psi	15 psi	30 psi	
ZPH23	.220	.312	1.63	1.92	2.3	2.8	3.3	4.0	4.6	5.6	6.5	7.3	45°	53°	60°	
ZPH28	.231	.312	2.0	2.3	2.8	3.4	4.0	4.8	5.6	6.9	7.9	8.9	40°	43°	48°	
ZPH51	.344	.375	3.5	4.2	5.0	6.1	7.1	8.7	10.0	12.2	14.1	15.8	40°	50°	50°	
ZPH53	.375	.375	3.5	4.2	5.0	6.1	7.1	8.7	10.0	12.2	14.1	15.8	70°	70°	70°	

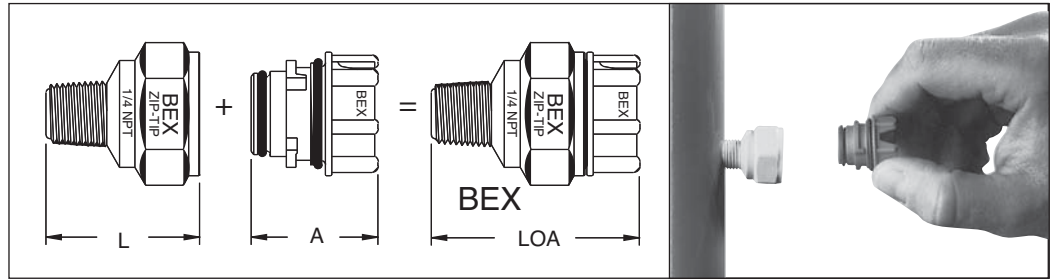

CHARACTERISTICS:

BEX Molded Plastic Zip-Tip® Spray Nozzles are designed to allow fast and easy installation and removal of spray nozzle tips and adapters, while providing positive alignment of spray pattern. Double VITON® O-Ring seals are supplied standard with each nozzle tip. Seals are located on, and removed with, the nozzle tip for easy flushing. A variety of models and spray patterns are available.

CONSTRUCTION:

Molded plastic spray nozzles are available in glass reinforced polypropylene or PVDF (Kynar®). Other materials are available upon request. All models are available in either NPT or BSPT threads. (NOTE: Metal and molded plastic ZIP-TIP® components are not interchangeable.)

DIMENSIONS

MODEL	DIM "L"	DIM "A"	DIM "LOA"
ZF	1.24	1.00	1.68
ZS	1.24	1.00	1.68
ZSW	1.24	1.00	1.68
ZTA	1.24	1.00	1.68
ZPLUG	1.24	1.00	1.68

TYPICAL APPLICATIONS:

- Spray Washing & Rinsing
- Parts Cleaning
- Pretreatment

ZIP-TIP® BODIES AND ADAPTERS



ZBD
1/8" - 1/2" NPT Male Only
Glass reinforced polypropylene or PVDF



KZBD
To be used with K-Ball® Clip-On Nozzle Assemblies.
Glass reinforced polypropylene or PVDF (See page 72)



ZTA
1/8" - 3/8" NPT Female Only
Glass reinforced polypropylene or PVDF



ZPLUG
To shut off individual nozzles
Glass reinforced polypropylene or PVDF

HOW TO ORDER BEX ZIP-TIPS

COMPLETE ASSEMBLIES:

Indicate ZBD connection size (1/8", 1/4", 3/8" or 1/2") followed by model number (ZF, ZS, ZSW or ZSQ) found on pages 65-68. Then indicate material of construction (Glass reinforced polypropylene, Red PVDF or Natural PVDF).

REPLACEMENT TIPS ONLY

Indicate the tip model number (ZF, ZS, ZSW or ZSQ) found on pages 65-68. Then indicate material of construction (Glass reinforced polypropylene, Red PVDF or Natural PVDF).



Zip-Tip® with Tabz™

Finger Tabz for easier insertion and removal.
Available on all models.

SPRAY CHARACTERISTICS:

ZF-Series spray nozzles produce a flat, fan-shaped spray pattern with spray angles available from 15° to 110° measured at 40 psi. Spray angles generally increase with pressure, as shown in the capacity table.

Spray density tapers off toward the outside of these sprays, to permit overlapping of spray patterns while maintaining uniform spray density.

CONSTRUCTION:

Molded plastic spray nozzles are available in glass reinforced polypropylene or PVDF (Kynar®).

COLOR CODING:

Zip-Tip flat "V" spray tips are color-coded for easy identification.

- Parts Cleaning
- Metal Washing
- Foam Control
- Asphalt Spraying
- Gravel Washing
- Vehicle Washing
- Fertilizer Spraying
- Dishwashers



Additional sizes may be available upon request. Please contact your BEX distributor.

See chart on page 65 for dimensions.

	ZF MODEL	TIP COLOR		CAPACITY (GPM) AT VARIOUS PRESSURES (psi)													SPRAY ANGLE @			
				5 psi	7 psi	10 psi	15 psi	20 psi	30 psi	40 psi	50 psi	60 psi	80 psi	100 psi	150 psi	300 psi	20 psi	40 psi	80 psi	
110°	ZF11003	Lime Green	.041	0.11	0.13	0.15	0.18	0.21	0.26	0.30	0.34	0.37	0.42	0.47	0.58	0.82	92°	110°	118°	
	ZF11004	Lime Green	.047	0.14	0.17	0.20	0.24	0.28	0.35	0.40	0.45	0.49	0.57	0.63	0.77	1.10	90°	110°	112°	
	ZF11005	Lime Green	.053	0.18	0.21	0.25	0.31	0.35	0.43	0.50	0.56	0.61	0.71	0.79	0.97	1.37	96°	110°	114°	
	ZF11006	Lime Green	.058	0.21	0.25	0.30	0.37	0.42	0.52	0.60	0.67	0.73	0.85	0.95	1.16	1.64	97°	110°	115°	
	ZF11008	Lime Green	.067	0.28	0.33	0.40	0.49	0.57	0.69	0.80	0.89	0.98	1.13	1.26	1.55	2.19	100°	110°	115°	
	ZF11010	White	.075	0.35	0.42	0.50	0.61	0.71	0.87	1.00	1.12	1.22	1.41	1.58	1.94	2.74	102°	110°	115°	
	ZF11015	Grey	.091	0.53	0.63	0.75	0.92	1.06	1.30	1.50	1.68	1.84	2.12	2.37	2.90	4.1	102°	110°	115°	
	ZF11020	Lt. Blue	.105	0.71	0.84	1.00	1.22	1.41	1.73	2.00	2.24	2.45	2.83	3.2	3.9	5.5	103°	110°	112°	
	ZF11030	Purple	.129	1.06	1.25	1.50	1.84	2.12	2.60	3.00	3.4	3.7	4.2	4.7	5.8	8.2	103°	110°	112°	
	ZF11040	Green	.149	1.41	1.67	2.00	2.45	2.83	3.5	4.0	4.5	4.9	5.7	6.3	7.7	11.0	103°	110°	112°	
	ZF11050	Yellow	.167	1.77	2.09	2.50	3.06	3.5	4.3	5.0	5.6	6.1	7.1	7.9	9.7	13.7	107°	110°	116°	
	ZF11060	Blue	.182	2.12	2.51	3.00	3.7	4.2	5.2	6.0	6.7	7.3	8.5	9.5	11.6	16.4	104°	110°	112°	
	ZF11070	Red	.197	2.47	2.93	3.5	4.3	4.9	6.1	7.0	7.8	8.6	9.9	11.1	13.6	19.2	107°	110°	112°	
	95°	ZF9503	Lime Green	.041	0.11	0.13	0.15	0.18	0.21	0.26	0.30	0.34	0.37	0.42	0.47	0.58	0.82	86°	95°	101°
		ZF9504	Lime Green	.047	0.14	0.17	0.20	0.24	0.28	0.35	0.40	0.45	0.49	0.57	0.63	0.77	1.10	86°	95°	101°
		ZF9505	Lime Green	.053	0.18	0.21	0.25	0.31	0.35	0.43	0.50	0.56	0.61	0.71	0.79	0.97	1.37	86°	95°	101°
ZF9506		Lime Green	.058	0.21	0.25	0.30	0.37	0.42	0.52	0.60	0.67	0.73	0.85	0.95	1.16	1.64	86°	95°	101°	
ZF9508		Lime Green	.067	0.28	0.33	0.40	0.49	0.57	0.69	0.80	0.89	0.98	1.13	1.26	1.55	2.2	86°	95°	100°	
ZF9510		White	.075	0.35	0.42	0.50	0.61	0.71	0.87	1.00	1.12	1.22	1.41	1.58	1.94	2.7	88°	95°	99°	
ZF9515		Grey	.091	0.53	0.63	0.75	0.92	1.06	1.30	1.5	1.68	1.84	2.1	2.4	2.9	4.1	90°	95°	100°	
ZF9520		Lt. Blue	.105	0.71	0.84	1.00	1.22	1.41	1.73	2.0	2.2	2.4	2.8	3.2	3.9	5.5	89°	95°	99°	
ZF9530		Purple	.129	1.06	1.25	1.50	1.84	2.1	2.6	3.0	3.4	3.7	4.2	4.7	5.8	8.2	90°	95°	101°	
ZF9540		Green	.149	1.41	1.67	2.0	2.4	2.8	3.5	4.0	4.5	4.9	5.7	6.3	7.7	11.0	90°	95°	100°	
ZF9550		Yellow	.167	1.77	2.1	2.5	3.1	3.5	4.3	5.0	5.6	6.1	7.1	7.9	9.7	13.7	91°	95°	101°	
ZF9560		Blue	.182	2.1	2.5	3.0	3.7	4.2	5.2	6.0	6.7	7.3	8.5	9.5	11.6	16.4	92°	95°	102°	
ZF9570		Red	.197	2.5	2.9	3.5	4.3	4.9	6.1	7.0	7.8	8.6	9.9	11.1	13.6	19.2	92°	95°	103°	
80°		ZF8002	Lime Green	.034	0.07	0.08	0.10	0.12	0.14	0.17	0.20	0.22	0.24	0.28	0.32	0.39	0.55	74°	80°	83°
		ZF8003	Lime Green	.041	0.11	0.13	0.15	0.18	0.21	0.26	0.30	0.34	0.37	0.42	0.47	0.58	0.82	74°	80°	83°
		ZF8004	Lime Green	.047	0.14	0.17	0.20	0.24	0.28	0.35	0.40	0.45	0.49	0.57	0.63	0.77	1.10	74°	80°	83°
	ZF8005	Lime Green	.053	0.18	0.21	0.25	0.31	0.35	0.43	0.50	0.56	0.61	0.71	0.79	0.97	1.37	74°	80°	83°	
	ZF8006	Lime Green	.058	0.21	0.25	0.30	0.37	0.42	0.52	0.60	0.67	0.73	0.85	0.95	1.16	1.64	74°	80°	83°	
	ZF8008	Lime Green	.067	0.28	0.33	0.40	0.49	0.57	0.69	0.80	0.89	0.98	1.13	1.26	1.55	2.2	75°	80°	83°	
	ZF8010	White	.075	0.35	0.42	0.50	0.61	0.71	0.87	1.00	1.12	1.22	1.41	1.58	1.94	2.7	75°	80°	83°	
	ZF8015	Grey	.091	0.53	0.63	0.75	0.92	1.06	1.30	1.5	1.68	1.84	2.1	2.4	2.9	4.1	74°	80°	86°	
	ZF8020	Lt. Blue	.105	0.71	0.84	1.00	1.22	1.41	1.73	2.0	2.2	2.4	2.8	3.2	3.9	5.5	74°	80°	85°	
	ZF8030	Purple	.129	1.06	1.25	1.50	1.84	2.1	2.6	3.0	3.4	3.7	4.2	4.7	5.8	8.2	75°	80°	86°	
	ZF8040	Green	.149	1.41	1.67	2.0	2.4	2.8	3.5	4.0	4.5	4.9	5.7	6.3	7.7	11.0	76°	80°	85°	
	ZF8050	Yellow	.167	1.77	2.1	2.5	3.1	3.5	4.3	5.0	5.6	6.1	7.1	7.9	9.7	13.7	77°	80°	84°	
	ZF8060	Blue	.182	2.1	2.5	3.0	3.7	4.2	5.2	6.0	6.7	7.3	8.5	9.5	11.6	16.4	77°	80°	84°	
	ZF8070	Red	.197	2.5	2.9	3.5	4.3	4.9	6.1	7.0	7.8	8.6	9.9	11.1	13.6	19.2	78°	80°	87°	
	65°	ZF6502	Lime Green	.034	0.07	0.08	0.10	0.12	0.14	0.17	0.20	0.22	0.24	0.28	0.32	0.39	0.55	53°	65°	72°
		ZF6503	Lime Green	.041	0.11	0.13	0.15	0.18	0.21	0.26	0.30	0.34	0.37	0.42	0.47	0.58	0.82	53°	65°	72°
ZF6504		Lime Green	.047	0.14	0.17	0.20	0.24	0.28	0.35	0.40	0.45	0.49	0.57	0.63	0.77	1.10	54°	65°	72°	
ZF6505		Lime Green	.053	0.18	0.21	0.25	0.31	0.35	0.43	0.50	0.56	0.61	0.71	0.79	0.97	1.37	54°	65°	72°	
ZF6506		Lime Green	.058	0.21	0.25	0.30	0.37	0.42	0.52	0.60	0.67	0.73	0.85	0.95	1.16	1.64	54°	65°	72°	
ZF6508		Lime Green	.067	0.28	0.33	0.40	0.49	0.57	0.69	0.80	0.89	0.98	1.13	1.26	1.55	2.2	55°	65°	71°	
ZF6510		White	.075	0.35	0.42	0.50	0.61	0.71	0.87	1.00	1.12	1.22	1.41	1.58	1.94	2.7	57°	65°	73°	
ZF6512		Orange	.082	0.42	0.50	0.60	0.73	0.85	1.04	1.20	1.34	1.47	1.70	1.90	2.3	3.3	59°	65°	71°	

ZIP-TIP®

ZS Series

Full cone spray nozzles

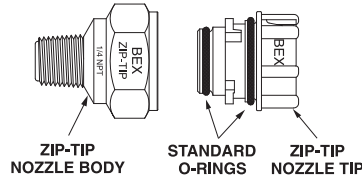
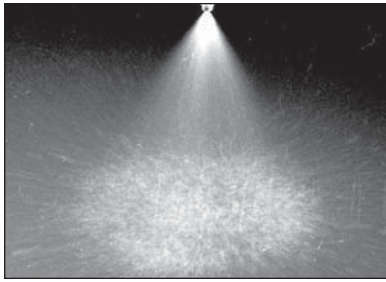

FULL-CONE SPRAY

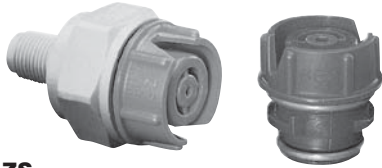

ZS

Spray Angles: Wide range
Capacities: Up to 2.2 G.P.M. @ 10 psi
Materials: Glass-filled Poly or PVDF

Features: A full-cone spray with uniform spray distribution. Removable patented vane is standard.

MODEL NUMBER	MAXIMUM FREE PASSAGE (inches)	CAPACITY (GPM) AT VARIOUS PRESSURES (psi)												Spray Angle @		
		3 psi	5 psi	7 psi	10 psi	15 psi	20 psi	30 psi	40 psi	60 psi	80 psi	100 psi	150 psi	7 psi	20 psi	80 psi
ZS1	.033	--	--	--	--	0.12	0.14	0.17	0.20	0.24	0.28	0.32	0.39	--	55°	52°
ZS1.5	.046	--	--	--	0.15	0.18	0.21	0.26	0.30	0.37	0.42	0.47	0.58	--	65°	57°
ZS2	.051	--	--	0.17	0.20	0.24	0.28	0.35	0.40	0.49	0.57	0.63	.077	54°	59°	60°
ZS3	.051	--	0.21	0.25	0.30	0.37	0.42	0.52	0.60	0.73	0.85	0.95	1.16	50°	53°	60°
ZS3.5	.051	0.19	0.25	0.29	0.35	0.43	0.49	0.61	0.70	0.86	0.99	1.11	1.36	48°	58°	61°
ZS5	.064	0.27	0.35	0.42	0.50	0.61	0.71	0.87	1.00	1.22	1.41	1.58	1.94	58°	68°	62°
ZS6	.064	0.33	0.42	0.50	0.60	0.73	0.85	1.04	1.20	1.47	1.70	1.90	2.3	67°	72°	70°
ZS6.5	.091	0.36	0.46	0.54	0.65	0.80	0.92	1.13	1.30	1.59	1.84	2.1	2.5	48°	56°	50°
ZS7.5	.091	0.41	0.53	0.63	0.75	0.92	1.06	1.30	1.50	1.84	2.1	2.4	2.9	55°	65°	48°
ZS8.5	.091	0.47	0.60	0.71	0.85	1.04	1.20	1.47	1.70	2.1	2.4	2.7	3.3	58°	65°	63°
ZS10	.091	0.55	0.71	0.84	1.00	1.22	1.41	1.73	2.0	2.4	2.8	3.2	3.9	55°	65°	50°
ZS14	.091	0.77	0.99	1.17	1.40	1.71	1.98	2.4	2.8	3.4	4.0	4.4	5.4	78°	85°	75°
ZS15	.102	0.82	1.06	1.25	1.50	1.84	2.1	2.6	3.0	3.7	4.2	4.7	5.8	63°	65°	60°
ZS18	.102	0.99	1.27	1.51	1.80	2.2	2.5	3.1	3.6	4.4	5.1	5.7	7.0	85°	88°	76°
ZS20	.102	1.10	1.41	1.67	2.0	2.4	2.8	3.5	4.0	4.9	5.7	6.3	7.7	76°	82°	75°
ZS22	.114	1.20	1.56	1.84	2.2	2.7	3.1	3.8	4.4	5.4	6.2	7.0	8.5	76°	78°	76°

WIDE ANGLE FULL-CONE

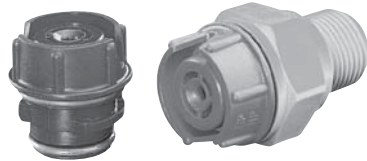

ZSW

Spray Angles: Up to 125° @ 10 psi
Capacities: Up to 2.4 G.P.M. @ 10 psi
Materials: Glass-filled Poly or PVDF

Features: A wide full-cone spray with uniform spray distribution. Removable patented vane is standard.

MODEL NUMBER	MAXIMUM FREE PASSAGE (inches)	CAPACITY (GPM) AT VARIOUS PRESSURES (psi)												Spray Angle @		
		5 psi	7 psi	10 psi	15 psi	20 psi	30 psi	40 psi	60 psi	80 psi	100 psi	150 psi	7 psi	20 psi	80 psi	
ZS2.8W	.051	--	0.23	0.28	0.34	0.40	0.48	0.56	0.69	0.79	0.89	1.08	1.10°	105°	96°	
ZS4.3W	.051	--	0.36	0.43	0.53	0.61	0.74	0.86	1.05	1.22	1.36	1.67	117°	108°	100°	
ZS5.6W	.064	--	0.47	0.56	0.69	0.79	0.97	1.12	1.37	1.58	1.77	2.2	117°	110°	100°	
ZS8W	.081	0.57	0.67	0.80	0.98	1.13	1.39	1.60	1.96	2.3	2.5	3.1	118°	110°	103°	
ZS10W	.091	0.71	0.84	1.00	1.22	1.41	1.73	2.0	2.4	2.8	3.2	3.9	118°	108°	102°	
ZS12W	.091	0.85	1.00	1.20	1.47	1.70	2.1	2.4	2.9	3.4	3.8	4.6	120°	112°	102°	
ZS14W	.091	0.99	1.17	1.40	1.71	1.98	2.4	2.8	3.4	4.0	4.4	5.4	118°	114°	104°	
ZS17W	.102	1.20	1.42	1.70	2.1	2.4	2.9	3.4	4.2	4.8	5.4	6.6	118°	117°	102°	
ZS20W	.102	1.41	1.67	2.0	2.4	2.8	3.5	4.0	4.9	5.7	6.3	7.7	120°	120°	106°	
ZS24W	.102	1.70	2.0	2.4	2.9	3.4	4.2	4.8	5.9	6.8	7.6	9.3	122°	118°	106°	

FULL-SQUARE SPRAY



ZSQ

Spray Angles: Wide range
Capacities: Up to 1.8 G.P.M. @ 10 psi
Materials: Glass-filled Poly or PVDF

Features: A full-square spray with uniform spray distribution. Removable patented vane is standard.

MODEL NUMBER	MAXIMUM FREE PASSAGE (inches)	CAPACITY (GPM) AT VARIOUS PRESSURES (psi)												Spray Angle @		
		5 psi	7 psi	10 psi	15 psi	20 psi	30 psi	40 psi	60 psi	80 psi	100 psi	150 psi	7 psi	20 psi	80 psi	
ZS3.6SQ	.057	--	0.30	0.36	0.44	0.51	0.62	0.72	0.88	1.02	1.14	1.39	42°	55°	50°	
ZS4.8SQ	.064	--	0.40	0.48	0.59	0.68	0.83	0.96	1.18	1.36	1.52	1.86	50°	65°	60°	
ZS6SQ	.081	--	0.50	0.60	0.73	0.85	1.04	1.20	1.47	1.70	1.90	2.3	30°	65°	60°	
ZS10SQ	.091	0.71	0.84	1.00	1.22	1.41	1.73	2.0	2.4	2.8	3.2	3.9	61°	67°	60°	
ZS12SQ	.091	0.85	1.00	1.20	1.47	1.70	2.1	2.4	2.9	3.4	3.8	4.6	71°	76°	69°	
ZS14SQ	.091	0.99	1.17	1.40	1.71	1.98	2.4	2.8	3.4	4.0	4.4	5.4	78°	85°	75°	
ZS18SQ	.091	1.27	1.51	1.80	2.2	2.5	3.1	3.6	4.4	5.1	5.7	7.0	85°	88°	76°	

Clip-on spray nozzles

K-Ball®

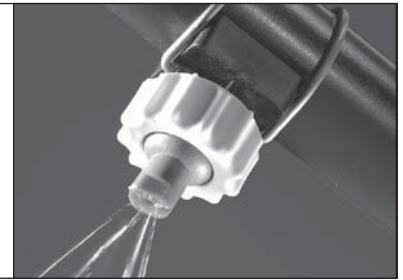
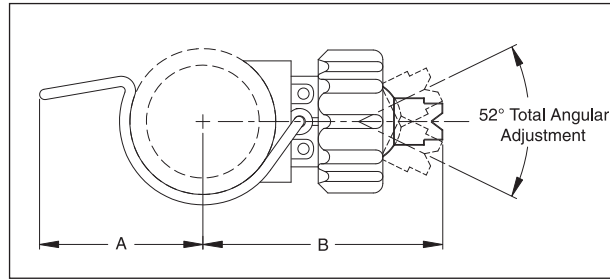

SPRAY CHARACTERISTICS:

These nozzles simply clip over a pre-drilled pipe (9/16" dia. hole) and are available with a variety of spray balls, in various spray patterns, flow rates and spray angles.

CONSTRUCTION:

Made of corrosion-resistant plastic and stainless steel. Heavy-duty spring clip good to 100 p.s.i. at 175° F. A 316SS clip is also available, if required.

DIMENSIONS

PIPE SIZE	Dim. A	Dim. B
1"	1 ³ / ₄ (45 mm)	2 ⁷ / ₈ (73 mm)
1 ¹ / ₄ "	2 (51 mm)	3 (77 mm)
1 ¹ / ₂ "	2 ¹ / ₈ (54 mm)	3 ¹ / ₈ (80 mm)
2"	2 ³ / ₈ (61 mm)	3 ¹ / ₂ (89 mm)

TYPICAL APPLICATIONS:

- Parts Cleaning
- Pretreatment
- Spray Washing & Rinsing

Double clip model also available.

THE BEX "FINGER" SYSTEM

The BEX spring clamp is the heaviest and most durable used in the industry. It provides long service at pressures up to 100 psi. Also available with a second clip.

Standard O-Ring seal is EPDM. Buna-N, Viton®, and special "retrofit" seals are available.

Square fitting glass filled polypropylene bodies are available in four pipe sizes and are good up to 175°F.

Hundreds of standard nozzle balls and spray options are available when using our threaded ball, below, or the Zip-Tip® nozzle adapter (see page 54).

BEX unique "Finger" system holds the ball securely in alignment to prevent movement when the cap is tightened. The "Finger" system is optional on all BEX K-Ball® adjustable nozzles.

The K-Ball® cap has strong buttress threads and is made from glass filled polypropylene or PVDF.

HOW TO ORDER COMPLETE K-BALL ASSEMBLIES

Use the correct body part number (from the parts listed in BOLD at the right), followed by the model number for the nozzle ball (see pages 70-72).

Example:

BF5070 nozzle balls are needed to fit onto a 1-1/4" pipe. Accurate alignment of the nozzles is critical, so the 1-1/4" body with "fingers" will be used. The correct PART number for this K-Ball nozzle assembly is 1.2KFBF5070.

K-BALL BODY COLORS AND PART NUMBERS

Pipe Sizes	1"	1-1/4"	1-1/2"	2"
Standard Body	1K (white)	1.2K (grey)	1.5K (black)	2K (tan)
Body with Fingers	1KF (green)	1.2KF (yellow)	1.5KF (red)	2KF (blue)
Spring Clip	1KCL	1.2KCL	1.5KCL	2KCL
O-ring	KOR	KOR	KOR	KOR
K-Ball Cap	KCAP	KCAP	KCAP	KCAP

SPRAY BALL: CHOOSE FROM THE TABLES ON PAGES 70 TO 72.

K-BALL CLIP-ON

BF FLAT-V SPRAY NOZZLE BALLS (for 1", 1-1/4", 1-1/2" and 2" pipe)

SPRAY CHARACTERISTICS:

Spray is fan-shaped with spray angles of 15° to 110°. Spray density tapers off toward the outside to permit overlapping of the spray patterns while maintaining uniform spray density.

COLOR CODING:

The more popular models of the flat-V spray nozzle balls are color coded by flowrate for easier identification.

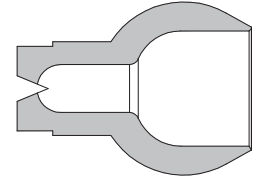

SPRAY ANGLE @ 40psi	MODEL NUMBER	SPRAY BALL COLOUR	EQUIV. ORIFICE DIAMETER (inches)	CAPACITY (GPM) AT VARIOUS PRESSURES(psi)										SPRAY ANGLE @	
				5 psi	7 psi	10 psi	15 psi	20 psi	25 psi	30 psi	40 psi	50 psi	20 psi	40 psi	
110°	BF11060	Blue	0.183	2.1	2.5	3.0	3.7	4.2	4.7	5.2	6.0	6.7	107°	110°	
95°	BF9530	Purple	0.129	1.06	1.25	1.50	1.84	2.1	2.4	2.6	3.0	3.4	63°	95°	
	BF9540	Green	0.149	1.41	1.67	2.0	2.4	2.8	3.2	3.5	4.0	4.5	63°	95°	
	BF9550	Yellow	0.167	1.77	2.1	2.5	3.1	3.5	4.0	4.3	5.0	5.6	63°	95°	
	BF9560	Blue	0.183	2.1	2.5	3.0	3.7	4.2	4.7	5.2	6.0	6.7	63°	95°	
80°	BF8010	White	0.238	0.35	0.42	0.50	0.61	0.71	0.79	0.87	1.0	1.12	75°	80°	
	BF8020	Light Blue	0.105	0.71	0.84	1.00	1.22	1.41	1.58	1.73	2.0	2.2	63°	80°	
	BF8030	Purple	0.129	1.06	1.25	1.50	1.84	2.1	2.4	2.6	3.0	3.4	63°	80°	
	BF8040	Green	0.149	1.41	1.67	2.0	2.4	2.8	3.2	3.5	4.0	4.5	76°	80°	
	BF8050	Yellow	0.167	1.77	2.1	2.5	3.1	3.5	4.0	4.3	5.0	5.6	77°	80°	
	BF8060	Blue	0.183	2.1	2.5	3.0	3.7	4.2	4.7	5.2	6.0	6.7	77°	80°	
	BF8070	Red	0.197	2.5	2.9	3.5	4.3	4.9	5.5	6.1	7.0	7.8	78°	80°	
	BF80100	Brown	0.238	3.5	4.2	5.0	6.1	7.1	7.9	8.7	10.0	11.2	75°	80°	
65°	BF6520	Light Blue	0.105	0.71	0.84	1.00	1.22	1.41	1.58	1.73	2.0	2.2	63°	65°	
	BF6530	Purple	0.129	1.06	1.25	1.50	1.84	2.1	2.4	2.6	3.0	3.4	63°	65°	
	BF6540	Green	0.149	1.41	1.67	2.0	2.4	2.8	3.2	3.5	4.0	4.5	63°	65°	
	BF6550	Yellow	0.167	1.77	2.1	2.5	3.1	3.5	4.0	4.3	5.0	5.6	63°	65°	
	BF6560	Blue	0.183	2.1	2.5	3.0	3.7	4.2	4.7	5.2	6.0	6.7	63°	65°	
	BF6570	Red	0.197	2.5	2.9	3.5	4.3	4.9	5.5	6.1	7.0	7.8	63°	65°	
	BF65100	Brown	0.238	3.5	4.2	5.0	6.1	7.1	7.9	8.7	10.0	11.2	58°	65°	
	50°	BF5020	Light Blue	0.105	0.71	0.84	1.00	1.22	1.41	1.58	1.73	2.0	2.2	63°	50°
BF5030		Purple	0.129	1.06	1.25	1.50	1.84	2.1	2.4	2.6	3.0	3.4	63°	50°	
BF5040		Green	0.149	1.41	1.67	2.0	2.4	2.8	3.2	3.5	4.0	4.5	43°	50°	
BF5050		Yellow	0.167	1.77	2.1	2.5	3.1	3.5	4.0	4.3	5.0	5.6	43°	50°	
BF5060		Blue	0.183	2.1	2.5	3.0	3.7	4.2	4.7	5.2	6.0	6.7	43°	50°	
BF5070		Red	0.197	2.5	2.9	3.5	4.3	4.9	5.5	6.1	7.0	7.8	43°	50°	
BF50100		Brown	0.238	3.5	4.2	5.0	6.1	7.1	7.9	8.7	10.0	11.2	44°	50°	
40°		BF4040	Green	0.149	1.41	1.67	2.0	2.4	2.8	3.2	3.5	4.0	4.5	33°	40°
	BF4050	Yellow	0.167	1.77	2.1	2.5	3.1	3.5	4.0	4.3	5.0	5.6	35°	40°	
	BF4060	Blue	0.183	2.1	2.5	3.0	3.7	4.2	4.7	5.2	6.0	6.7	37°	40°	
	BF4070	Red	0.197	2.5	2.9	3.5	4.3	4.9	5.5	6.1	7.0	7.8	35°	40°	
	BF40100	Brown	0.238	3.5	4.2	5.0	6.1	7.1	7.9	8.7	10.0	11.2	33°	40°	
25°	BF2540	Green	0.149	1.41	1.67	2.0	2.4	2.8	3.2	3.5	4.0	4.5	22°	25°	
	BF2550	Yellow	0.167	1.77	2.1	2.5	3.1	3.5	4.0	4.3	5.0	5.6	20°	25°	
	BF2560	Blue	0.183	2.1	2.5	3.0	3.7	4.2	4.7	5.2	6.0	6.7	18°	25°	
	BF2570	Red	0.197	2.5	2.9	3.5	4.3	4.9	5.5	6.1	7.0	7.8	19°	25°	
	BF25100	Brown	0.236	3.5	4.2	5.0	6.1	7.1	7.9	8.7	10.0	11.2	21°	25°	
15°	BF15100	Brown	0.236	3.5	4.2	5.0	6.1	7.1	7.9	8.7	10.0	11.2	13°	15°	
	BF15120	Black	0.258	4.2	5.0	9.0	7.3	8.5	9.4	10.4	12.0	13.4	12°	15°	
	BF15150	Black	0.289	5.3	6.3	7.5	9.2	10.6	11.9	13.0	15.0	16.8	12°	15°	

ZIP-TIP®

BFL FLOODING SPRAY NOZZLE BALLS

(for 1", 1-1/4", 1-1/2" and 2" pipe)

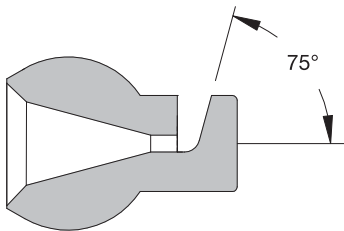

SPRAY CHARACTERISTICS:

A wide, flat shaped spray with low impact. The spray is deflected 75° from the centerline of the nozzle, as shown.

TYPICAL APPLICATIONS:

Flooding nozzles are often used at the beginning and end of phosphate stages, to prevent mist carry over. They can also be used for "wetting" surfaces during long drain stages.

MODEL NUMBER	EQUIV. ORIFICE DIAMETER (inches)	CAPACITY (GPM) AT VARIOUS PRESSURES (psi)										SPRAY ANGLE @	
		3 psi	5 psi	7 psi	10 psi	15 psi	20 psi	25 psi	30 psi	40 psi	50 psi	7 psi	20 psi
BFL5	0.183	0.27	0.35	0.42	0.50	0.61	0.71	0.79	0.87	1.00	1.12	114°	130°
BFL10	0.075	0.55	0.71	0.84	1.00	1.22	1.41	1.58	1.73	2.0	2.2	134°	146°
BFL18	0.149	0.99	1.27	1.51	1.80	2.2	2.5	2.8	3.1	3.6	4.0	130°	142°
BFL24	0.167	1.31	1.70	2.0	2.4	2.9	3.4	3.8	4.2	4.8	5.4	121°	136°
BFL30	0.183	1.64	2.1	2.5	3.0	3.7	4.2	4.7	5.2	6.0	6.7	120°	133°
BFL40	0.218	2.2	2.8	3.3	4.0	4.9	5.7	6.3	6.9	8.0	8.9	130°	144°

BPH HOLLOW CONE PHOSPHATING NOZZLE BALLS

(for 1", 1-1/4", 1-1/2" and 2" pipe)

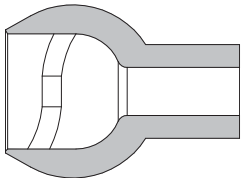

SPRAY CHARACTERISTICS:

A hollow cone pattern with low impact. BPH nozzle balls are made of glass reinforced polypropylene. Available in three models.

Designed specifically for phosphate stages. This large droplet, low impact spray results in tighter and more consistent phosphate crystalline structure. It minimizes the misting of phosphate spray, thus reducing 'pre-coating', streaking, and carry over to adjacent stages.

MODEL NUMBER	SPRAY BALL COLOR	MAXIMUM FREE PASSAGE (inches)	CAPACITY (GPM) AT VARIOUS PRESSURES (psi)										SPRAY ANGLE @			
			3 psi	5 psi	7 psi	10 psi	15 psi	20 psi	25 psi	30 psi	40 psi	5 psi	7 psi	10 psi	20 psi	
BPH28	White	0.191	1.53	1.98	2.3	2.8	3.4	4.0	4.4	4.8	5.60	44°	52°	53°	55°	
BPH51	Grey	0.280	2.7	3.5	4.2	5.0	6.1	7.1	7.9	8.7	10.0	37°	40°	42°	48°	
BPH53	Black	0.280	2.7	3.5	4.2	5.0	6.1	7.1	7.9	8.7	10.0	62°	70°	71°	73°	

K-PLUG SHUT-OFF NOZZLE BALL

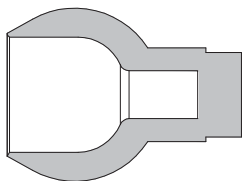

TYPICAL APPLICATIONS:

The K-PLUG nozzle ball is used in place of any other nozzle ball to completely shut off the flow through the nozzle.

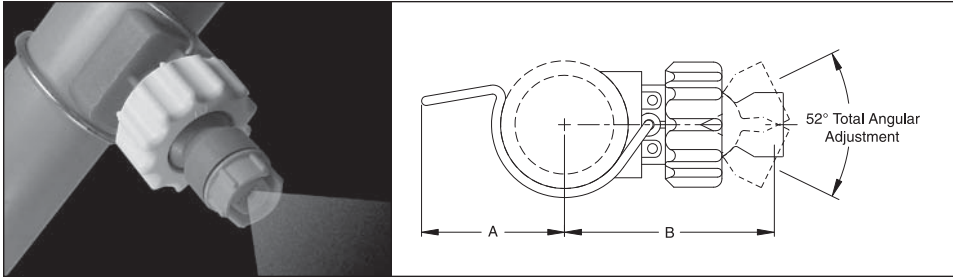

CLIP-ON ZIP-TIP® ADAPTERS

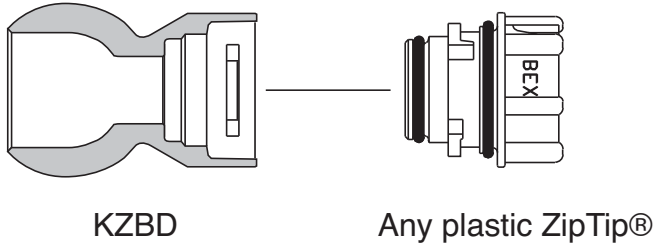

KZBD

Any plastic ZipTip®

THREADED BALLS (for K-Ball nozzle assemblies)

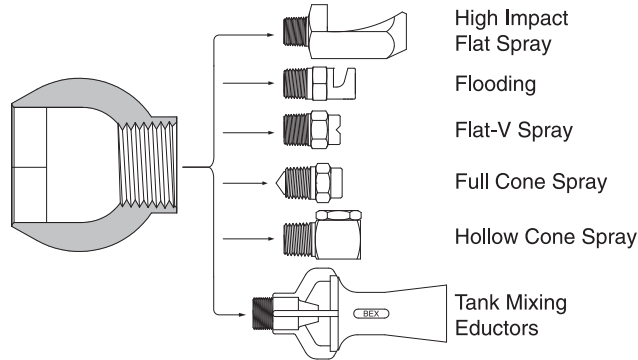

Ball has a hexagonal interior for easy holding!

TYPICAL APPLICATIONS:

Expand your range of nozzle choices by using threaded balls. Threaded balls are made of glass reinforced polypropylene, with 1/8", 1/4" and 3/8" NPT female threads. (BSPT also available)

MODEL	DESCRIPTION
1B	1/8" NPT Female thread
2B	1/4" NPT Female thread
3B	3/8" NPT Female thread
5B	1/2" NPT Female thread

Please note: The 5B has an angular adjustment of only 34°.

CONVERSION O-RING

For installing BEX K-Ball clip-on nozzles into holes drilled to a 21/32 diameter.



Replaces the standard BEX O-Ring

Threaded bodies

K-Ball®

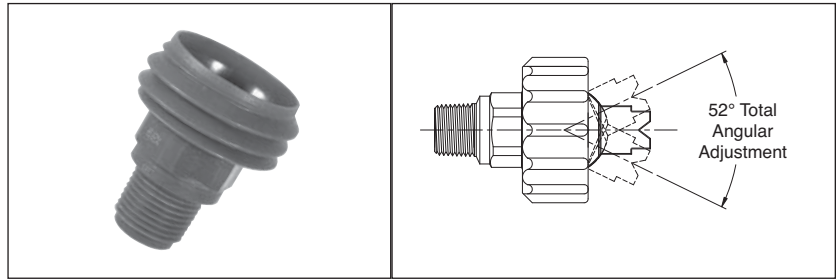

The BEX threaded K-Ball® body provides the ability to adjust the direction of the spray pattern by simply twisting the K-Ball® cap, repositioning the nozzle and tightening the cap. The same 52° nozzle angle of adjustability exists in the threaded body

as in the K-Ball® clip-on body. This plastic threaded body is useful when a metal clip is undesirable or where space limitations prevent using a spring clip-on nozzle.

ORDERING ASSEMBLIES:

You can easily order complete threaded K-Ball® ball assemblies using the ball model numbers listed on page 70. Example 3/8KFBF5070

MODELS AVAILABLE:

MALE NPT THREAD	MODEL NUMBER	
	Without "Fingers"	With "Fingers"
1/4	1/4KBD	1/4KFBD
3/8	3/8KBD	3/8KFBD
1/2	1/2KBD	1/2KFBD

*BSPT also available

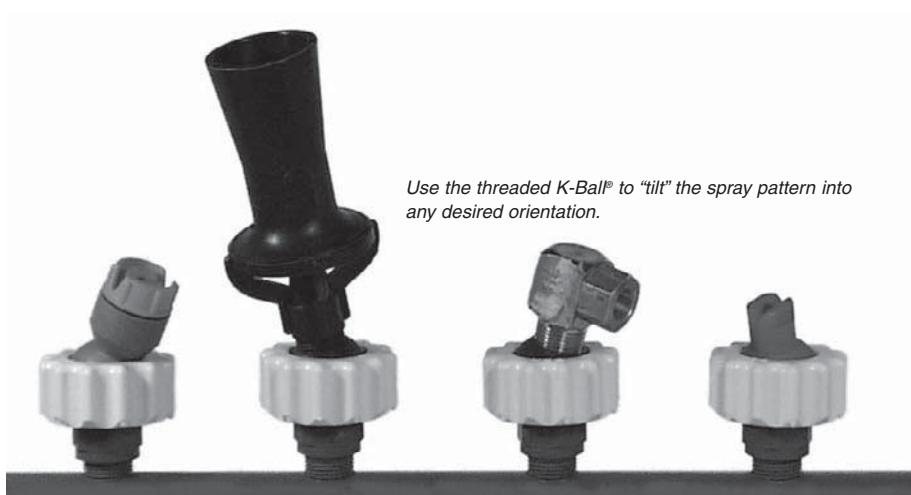
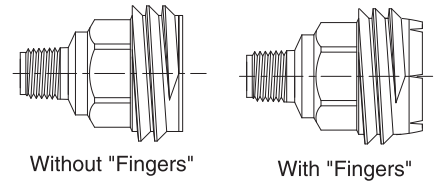

CLIP-ON NOZZLE THREADED ADAPTER (for 1", 1 1/4", 1 1/2" and 2" pipe)

FEATURES:

This adapter allows for quick mounting and removal of threaded nozzles.

APPLICATIONS:

Useful to mount nozzles in a fixed position, where adjustability is not desired.

(Drill a 9/16" diameter hole)

ADAPTER THREAD	MODEL NUMBER			
	1" Pipe	1 1/4" Pipe	1 1/2" Pipe	2" Pipe
1/8 NPT Female	1K.1	1.2K.1	1.5K.1	2K.1
1/4 NPT Female	1K.2	1.2K.2	1.5K.2	2K.2
3/8 NPT Female	1K.3	1.2K.3	1.5K.3	2K.3

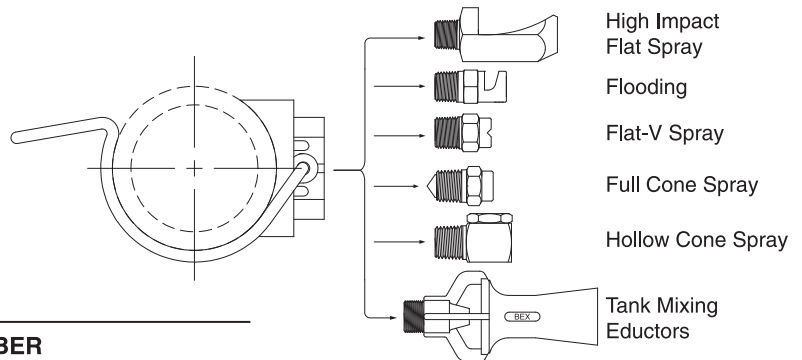

Double clip model also available.

All references to G.P.M. mean U.S. G.P.M.

K-BALL CLIP-ON

Other Nozzles And Accessories



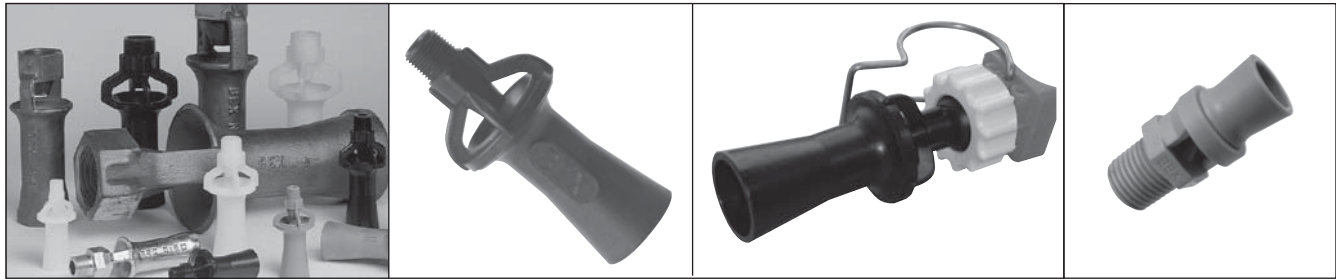

Eductor installed in a K-Ball assembly.
See page 72 for more information.

EDUCTOR PRINCIPLES:

BEX eductors use a unique venturi design which enables smaller pumps to circulate large volumes of tank solution. The eductor will circulate four to five gallons of solution for each gallon pumped.

BEX eductors are used for mixing chemicals, suspending solids, adjusting pH, "sweeping" debris or sludge toward a filter intake and many other useful applications.

CONSTRUCTION:

Standard materials are cast iron, 316 SS, PVDF (Kynar®) and glass-filled polypropylene. Other materials are available upon request.

TYPICAL APPLICATIONS:

- Plating Tanks
- Cleaning Tanks
- Phosphating Tanks
- E-coat Tanks
- Fertilizer Tanks
- Pulp Tanks
- Sludge Tanks
- Paint Booths
- Anodizing Tanks
- Cooling Towers
- Decorative Fountains

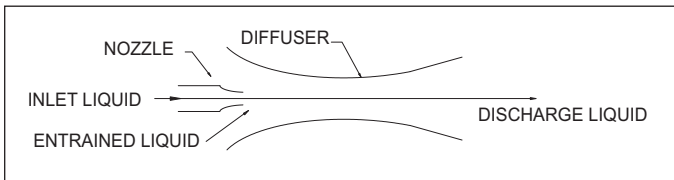

Sizes from 1/4" to 3" N.P.T. (BSPT models also available)

MINI PLASTIC MODELS

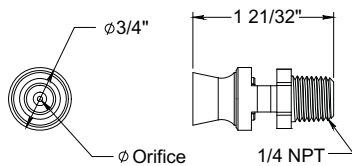

MODEL NUMBER	MAXIMUM FREE PASSAGE (inches)	COLOR	NOZZLE FLOW (GPM) AT VARIOUS PRESSURES (psi)							
			10 psi	15 psi	20 psi	25 psi	30 psi	40 psi	50 psi	Ent Ratio
TMMP6	0.059	Red	0.31	0.38	0.43	0.48	0.53	0.61	0.68	4.7
TMMP11	0.079	Green	0.55	0.67	0.78	0.87	0.95	1.10	1.23	3.7
TMMP18	0.098	Blue	0.90	1.10	1.27	1.42	1.56	1.80	2.01	2.2
TMMP26	0.118	Yellow	1.30	1.59	1.84	2.06	2.25	2.60	2.91	1.6

MOLDED PLASTIC MODELS

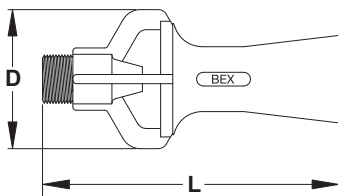

MODEL NUMBER	MAXIMUM FREE PASSAGE (inches)	NOZZLE FLOW (GPM) AT VARIOUS PRESSURES (psi)								
		10 psi	15 psi	20 psi	25 psi	30 psi	35 psi	40 psi	50 psi	psi
T00MP	0.188	3.2	3.9	4.5	5.0	5.5	5.9	6.3	7.1	
T0MP	0.288	7.5	9.2	10.6	11.9	13.0	14.0	15.0	16.8	
T2MP	0.386	13.5	16.5	19.1	21	23	25	27	30	
T3MP	0.481	21	26	30	33	36	39	42	47	
T4MP	0.612	33	40	47	52	57	62	66	74	

DIMENSIONS

MODEL NUMBER	Pipe Size	Dim. L	Dim. D
T00MP	1/4 NPT Male	3 1/8	1 1/2
T0MP	3/8 NPT Male	4 1/2	2 1/8
T2MP	3/4 NPT Male	6 3/8	3
T3MP	1 NPT Male	8 1/2	3 3/4
T4MP	1 1/2 NPT Male	9 7/8	4 5/8

EDUCTOR CIRCULATION RATIO OF SUPPLY TO DISCHARGE IS 1:5

The capacity table provides the flow of water through the nozzle orifice. To determine total discharge, multiply this value by five (5).

AVAILABLE IN GLASS REINFORCED POLYPROPYLENE AND PVDF (KYNAR®)

BEX 316SS INVESTMENT CAST TANK MIXING EDUCTORS

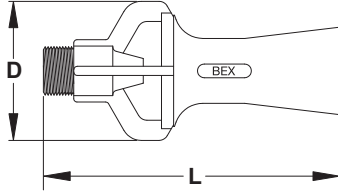

CONSTRUCTION:

These precision investment cast models are available in 316 stainless steel and alloy 20. Other materials are available on request.

The capacity table provides the flow of water through the nozzle orifice. To determine the discharge, multiply this value by five (5).

DIMENSIONS

MODEL NUMBER	Pipe Size	Dim. L	Dim. D
T0M	3/8" NPT Male	4 1/2"	2 1/8"
T2M	3/4" NPT Male	6 3/8"	3"
T22M	3/4" NPT Male	6 3/8"	3"
T3M	1" NPT Male	8 1/2"	3 3/4"
T4M	1 1/2" NPT Male	9 7/8"	4 5/8"
T5	2" NPT Female	12 1/4"	4 7/8"
T6	3" NPT Female	17 1/8"	7 1/2"

MODEL NUMBER	MAXIMUM FREE PASSAGE (inches)	NOZZLE FLOW (GPM) AT VARIOUS PRESSURES (psi)							
		10 psi	15 psi	20 psi	25 psi	30 psi	35 psi	40 psi	50 psi
T0M	0.288	7.5	9.2	10.6	11.9	13.0	14.0	15.0	16.8
T22M	0.386	13.5	16.5	19.1	21	23	25	27	30
T2M	0.422	16.1	19.7	22.8	25	27	30	32	36
T3M	0.481	21	26	30	33	36	39	42	47
T4M	0.612	33	40	47	52	57	62	66	74
T5	0.781	55	67	78	87	95	103	110	123
T6	1.188	126	154	178	199	218	236	252	282

BEX CAST IRON EDUCTORS

Includes 1-1/2", 2" & 3" 316SS models

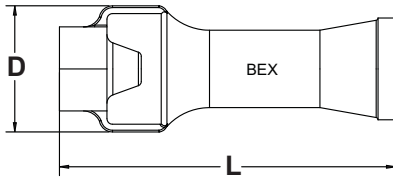

The capacity table provides the flow of water through the nozzle orifice. To determine discharge, multiply this value by five (5).

DIMENSIONS

MODEL NUMBER	Pipe Size	Dim. L	Dim. D
T4	1 1/2" NPT Female	9 1/2"	3 3/4"
T5	2" NPT Female	12 1/4"	4 7/8"
T6	3" NPT Female	17 1/8"	7 1/2"

MODEL NUMBER	MAXIMUM FREE PASSAGE (inches)	NOZZLE FLOW (GPM) AT VARIOUS PRESSURES (psi)							
		10 psi	15 psi	20 psi	25 psi	30 psi	35 psi	40 psi	50 psi
T4	0.612	33	40	47	52	57	62	66	74
T5	0.781	55	67	78	87	95	103	110	123
T6	1.188	126	154	178	199	218	236	252	282

USING BEX EDUCTORS AS STEAM SPARGERS

(for 1", 1 1/4", 1 1/2" and 2" pipe)

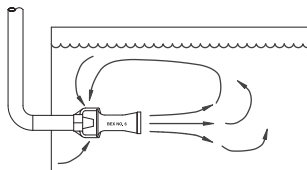

APPLICATIONS:

BEX Steam Spargers heat water and other liquids quickly and efficiently by direct injection of steam. They are designed for tank immersion and eliminate water hammer noise.

SELECTING THE RIGHT EDUCTOR:

(1) Calculate the required steam flow rate from the following equation:

$$\text{Steam Required (lbs./hr.)} = \frac{\text{Temp. increase of water (}^{\circ}\text{F)} \times \text{weight of water (lbs.)}}{\text{Time allowed to heat tank (hrs.)} \times 1000}$$

(2) Knowing the steam flow rate and the steam pressure available at the sparger, choose the sparger(s) from the table below. Using several small spargers may be advisable to using one large sparger.

(3) To help eliminate steam hammer, ensure that the minimum absolute pressure of the eductor is at least twice the absolute pressure inside the tank, at eductor depth.

Note:

- 1 Imperial gallon of water = 10.00 lbs.
- 1 cubic foot of water = 62.40 lbs.
- 1 U.S. gallon of water = 8.33 lbs.
- 1 litre of water = 2.20 lbs.

MODEL NUMBER	MAXIMUM FREE PASSAGE (inches)	STEAM CAPACITIES (lbs/hr) AT VARIOUS STEAM PRESSURES (psi)							
		20 psi	30 psi	40 psi	60 psi	80 psi	100 psi	120 psi	150 psi
T0M	0.288	136	175	214	293	371	450	528	646
T2M	0.386	212	273	334	456	579	701	823	1006
T3M	0.481	352	453	555	758	961	1164	1366	1671
T4	0.612	590	760	930	1270	1610	1950	2290	2800
T5	0.781	896	1154	1412	1929	2445	2962	3478	4253
T6	1.188	1975	2544	3113	4252	5390	6528	7667	9374

Tank washing assembly

TWA Series

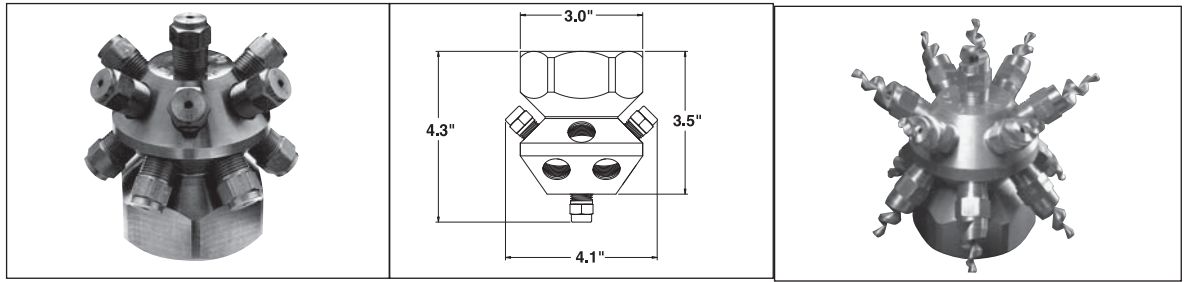

TYPICAL APPLICATIONS:

This assembly is suitable for a variety of tank washing applications where the maximum tank diameter is no greater than approximately 10 feet. The assembly will pass through a tank opening of at least 4.1" in diameter.

SPRAY CHARACTERISTICS:

This unit provides a fixed, non-rotating spray pattern. The assembly body has 13 individual female NPT nozzle connections which are designed to accept full cone nozzles. For best results, select 'S' series full cone spray nozzles from page 30. A wide variety of flow rates are available. A few standard combinations are listed in the table below.

CONSTRUCTION:

The assembly is available in brass, 303 and 316 stainless steel. A 1 1/2" female NPT connection attaches to the supply line. Maximum recommended operating pressure is 60 psi.

FULL-CONE SPRAY NOZZLES		CAPACITIES (GPM) AT VARIOUS PRESSURES (psi)						
ONE PIECE BODY - REMOVABLE INSERT	TWO PIECE BODY - REMOVABLE INSERT	10 psi	20 psi	30 psi	40 psi	60 psi	80 psi	100 psi
1 1/2 TWA 1/4 S5	1 1/2 TWA 1/4 GS5	6.5	9.2	11.3	13.0	15.9	18.4	21
1 1/2 TWA 1/4 S10	1 1/2 TWA 1/4 GS10	13.0	18.4	23	26	32	37	41
1 1/2 TWA 3/8 S15	1 1/2 TWA 3/8 GS15	20	28	35	40	49	57	63
1 1/2 TWA 3/8 S22	1 1/2 TWA 3/8 GS22	29	41	50	58	71	82	92

These assemblies are also available with BEX Twisters®

Cluster nozzle assembly

M7S Series

PRODUCT DESCRIPTION:

The M7S series cluster nozzle uses an array of seven (7) GS style full-cone spray nozzle caps mounted on a cluster nozzle body to produce a full-cone spray. Multiple full-cone spray nozzle caps produce a relatively small droplet size for large flow rates and are less susceptible to clogging. Nozzle caps are easily removed for cleaning or nozzle change-out.

CONSTRUCTION:

Standard cluster nozzle body and cap materials are brass, 303 stainless steel and 316 stainless steel. Other body and cap materials are available upon request.

U.S. Patent No. 4,142,682
Canadian Patent No. 1,050,589

TYPICAL APPLICATIONS:

- Chemical Processing
- Cooling Sprays
- Stack Gas Scrubbers

DIMENSIONS

NOZZLE TYPE	Dim. A	Dim. L
3/4 M7S	2.4	2.1
1 M7S	2.9	2.5
1 1/2 M7S	4.1	3.4

MODEL NUMBER	PIPE SIZE - NPT FEMALE	NOZZLE CAP MODEL #	CAPACITIES (GPM) AT VARIOUS PRESSURES (psi)						
			20 psi	40 psi	60 psi	80 psi	100 psi	125 psi	150 psi
3/4 M7S1	3/4	1/8 GS1	0.98	1.39	1.70	1.96	2.2	2.5	2.7
3/4 M7S1.5	3/4	1/8 GS1.5	1.50	2.1	2.6	3.0	3.4	3.8	4.1
3/4 M7S2	3/4	1/8 GS2	2.0	2.8	3.5	4.0	4.5	5.0	5.5
3/4 M7S3	3/4	1/8 GS3	2.9	4.1	5.0	5.8	6.5	7.3	7.9
3/4 M7S3.5	3/4	1/8 GS3.5	3.4	4.8	5.9	6.8	7.6	8.5	9.3
3/4 M7S5	3/4	1/8 GS5	5.0	7.1	8.7	10.0	11.2	12.5	13.7
3/4 M7S6	3/4	1/8 GS6	6.0	8.5	10.4	12.0	13.4	15.0	16.4
1 M7S6.5	1	1/4 GS6.5	6.4	9.1	11.1	12.8	14.3	16.0	17.5
1 M7S7.5	1	1/4 GS7.5	7.4	10.5	12.8	14.8	16.5	18.5	20
1 M7S10	1	1/4 GS10	9.9	14.0	17.1	19.8	22	25	27
1 1/2 M7S9.5	1 1/2	3/8 GS9.5	9.4	13.3	16.3	18.8	21	24	26
1 1/2 M7S15	1 1/2	3/8 GS15	14.7	21	25	29	33	37	40
1 1/2 M7S16	1 1/2	1/2 GS16	16	23	28	32	36	40	44
1 1/2 M7S20	1 1/2	3/8 GS20	20	28	34	39	44	49	54
1 1/2 M7S22	1 1/2	3/8 GS22	22	31	38	44	49	55	60
1 1/2 M7S25	1 1/2	1/2 GS25	25	35	43	50	56	63	68
1 1/2 M7S32	1 1/2	1/2 GS32	32	45	55	64	72	80	88
1 1/2 M7S40	1 1/2	1/2 GS40	40	57	69	80	89	100	110

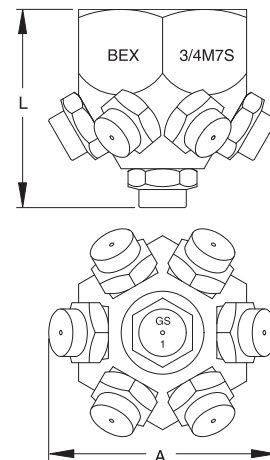



PRODUCT DESCRIPTION:

The M7C series cluster nozzles uses an array of seven (7) hollow cone C-series hydraulic atomizing nozzle caps mounted on a cluster nozzle body to produce a radially oriented array of hollow cone sprays. Multiple hydraulic atomizing spray nozzle caps produce a small droplet size with a higher flow rate and larger distribution than a single nozzle assembly. Nozzle caps are easily removed for nozzle change-out.

CONSTRUCTION:

Standard cluster nozzle body and cap materials are brass, 303 stainless steel and 316 stainless steel. Other body and cap materials are available upon request.

TYPICAL APPLICATIONS:

- Chemical Processing
- Cooling Sprays
- Stack Gas Scrubbers

Model	CAPACITY AT VARIOUS PRESSURES (USGPH)								
	30 psi	40 psi	80 psi	100 psi	200 psi	300 psi	500 psi	700 psi	1000 psi
1M7C1.9	3.6	4.1	5.8	6.5	9.2	11.3	14.6	17.3	20.6
1M7C2.4	4.5	5.2	7.4	8.2	11.7	14.3	18.4	21.8	26.1
1M7C3.0	5.6	6.5	9.2	10.3	14.6	17.8	23.0	27.3	33
1M7C3.8	7.1	8.3	11.7	13.1	18.5	22.6	29.2	35	41
1M7C4.7	8.8	10.2	14.4	16.1	22.8	28.0	36	43	51
1M7C5.9	11.1	12.8	18.1	20.3	28.7	35	45	54	64
1M7C7.4	13.9	16.1	22.7	25.4	36	44	57	67	80
1M7C9.2	17.3	20.0	28.3	31.6	45	55	71	84	100
1M7C12	22.6	26.1	37	41	58	71	92	109	130
1M7C14	26.3	30.4	43	48	68	83	108	127	152
1M7C18	34	39	55	62	87	107	138	164	195
1M7C23	43	50	71	79	112	137	177	209	250
1M7C28	53	61	86	96	136	167	215	254	304
1M7C35	66	76	108	120	170	208	269	318	380
1M7C44	83	96	135	151	214	262	338	400	478
1M7C55	103	119	169	189	267	327	422	500	597
1M7C69	130	150	212	237	335	410	530	627	749
1M7C86	162	187	264	295	418	512	660	781	934

Made with a 1" female pipe thread

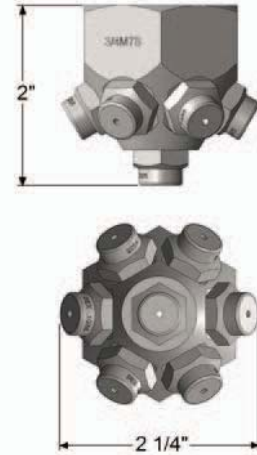

Rotating nozzles

TWK Series

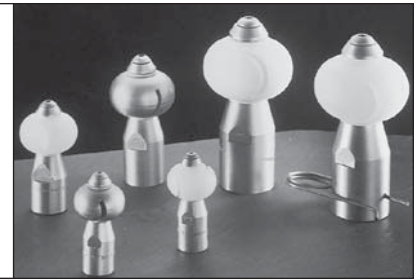
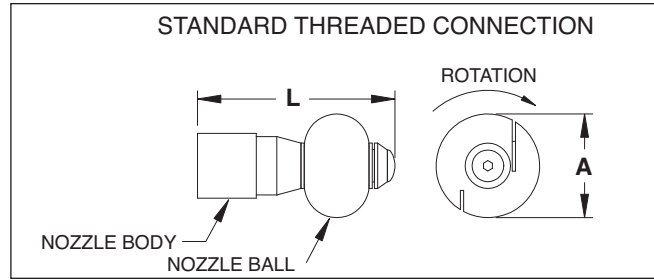

PRODUCT DESCRIPTION:

The TWK series rotating nozzles provide true 360° spray coverage in a very compact assembly. The bearing mechanism is self-lubricating and self-cleaning. This nozzle can be installed in any orientation and is effective in vessels up to 3 meters (10 feet) in diameter. The maximum recommended operating pressure is 100 psi at 180°F.

SPECIAL FEATURES:

- True 360° coverage
- Easy disassembly/assembly and cleaning
- FDA approved materials
- Keyed ball can not be installed backwards

TYPICAL APPLICATIONS:

- Keg Washing
- Carboy/Jug Washing
- Spray Tank Washing
- Small Tank Rinsing
- Machine Clean-In-Place (C.I.P.)
- Barrel Washing/Rinsing

U.S. Patent No. 5,316,218

CONSTRUCTION:

Standard nozzle body material is 316 stainless steel. Nozzle balls are available in 316 stainless steel, PVDF (Kynar®), Teflon® and polypropylene. Other body and ball materials are available upon request.

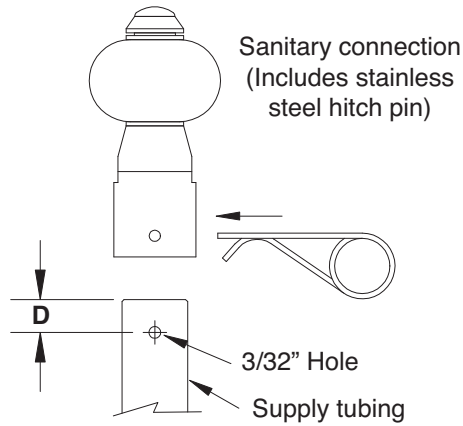

Spray Coverage



TWK360xxx



TWK270xxx



TWK072xxx



TWK180xxx



TWK081xxx

MODEL NUMBER	PIPE SIZE NPT FEMALE	MAXIMUM FREE PASSAGE (inches)	SANITARY TUBING SIZE*	CAPACITY (GPM) AT VARIOUS PRESSURES (psi)											SPRAY COVERAGE (degrees)	Dim. A (inches)	Dim. L (inches)	Dim. D (inches)
				5 psi	7 psi	10 psi	15 psi	20 psi	30 psi	40 psi	50 psi	60 psi	80 psi	100 psi				
1/4TWK36050	1/4	0.063	1/2	1.77	2.1	2.5	3.1	3.5	4.3	5.0	5.6	6.1	7.1	7.9	360°	1.0	2.0	3/8
1/4TWK27050	1/4	0.063	1/2	1.77	2.1	2.5	3.1	3.5	4.3	5.0	5.6	6.1	7.1	7.9	270°	1.0	2.0	3/8
1/4TWK07250	1/4	0.063	1/2	1.77	2.1	2.5	3.1	3.5	4.3	5.0	5.6	6.1	7.1	7.9	270°	1.0	2.0	3/8
1/4TWK18050	1/4	0.063	1/2	1.77	2.1	2.5	3.1	3.5	4.3	5.0	5.6	6.1	7.1	7.9	180°	1.0	2.0	3/8
1/4TWK08150	1/4	0.063	1/2	1.77	2.1	2.5	3.1	3.5	4.3	5.0	5.6	6.1	7.1	7.9	180°	1.0	2.0	3/8
3/8TWK36075	3/8	0.063	5/8	2.7	3.1	3.8	4.6	5.3	6.5	7.5	8.4	9.2	10.6	11.9	360°	1.25	2.5	3/8
3/8TWK27075	3/8	0.063	5/8	2.7	3.1	3.8	4.6	5.3	6.5	7.5	8.4	9.2	10.6	11.9	270°	1.25	2.5	3/8
3/8TWK07275	3/8	0.063	5/8	2.7	3.1	3.8	4.6	5.3	6.5	7.5	8.4	9.2	10.6	11.9	270°	1.25	2.5	3/8
3/8TWK18075	3/8	0.063	5/8	2.7	3.1	3.8	4.6	5.3	6.5	7.5	8.4	9.2	10.6	11.9	180°	1.25	2.5	3/8
3/8TWK08175	3/8	0.063	5/8	2.7	3.1	3.8	4.6	5.3	6.5	7.5	8.4	9.2	10.6	11.9	180°	1.25	2.5	3/8
1/2TWK360100	1/2	0.063	3/4	3.5	4.2	5.0	6.1	7.1	8.7	10.0	11.2	12.2	14.1	15.8	360°	1.5	2.9	3/8
1/2TWK270100	1/2	0.063	3/4	3.5	4.2	5.0	6.1	7.1	8.7	10.0	11.2	12.2	14.1	15.8	270°	1.5	2.9	3/8
1/2TWK072100	1/2	0.063	3/4	3.5	4.2	5.0	6.1	7.1	8.7	10.0	11.2	12.2	14.1	15.8	270°	1.5	2.9	3/8
1/2TWK180100	1/2	0.063	3/4	3.5	4.2	5.0	6.1	7.1	8.7	10.0	11.2	12.2	14.1	15.8	180°	1.5	2.9	3/8
1/2TWK081100	1/2	0.063	3/4	3.5	4.2	5.0	6.1	7.1	8.7	10.0	11.2	12.2	14.1	15.8	180°	1.5	2.9	3/8
3/4TWK360180	3/4	0.088	1	6.4	7.5	9.0	11.0	12.7	15.6	18.0	20	22	25	28	360°	2.0	3.9	1/2
3/4TWK270180	3/4	0.088	1	6.4	7.5	9.0	11.0	12.7	15.6	18.0	20	22	25	28	270°	2.0	3.9	1/2
3/4TWK072180	3/4	0.088	1	6.4	7.5	9.0	11.0	12.7	15.6	18.0	20	22	25	28	270°	2.0	3.9	1/2
3/4TWK180180	3/4	0.088	1	6.4	7.5	9.0	11.0	12.7	15.6	18.0	20	22	25	28	180°	2.0	3.9	1/2
3/4TWK081180	3/4	0.088	1	6.4	7.5	9.0	11.0	12.7	15.6	18.0	20	22	25	28	180°	2.0	3.9	1/2

**Add prefix "S" (ie S 1/4 TWK36050) to model number for Sanitary Connection.

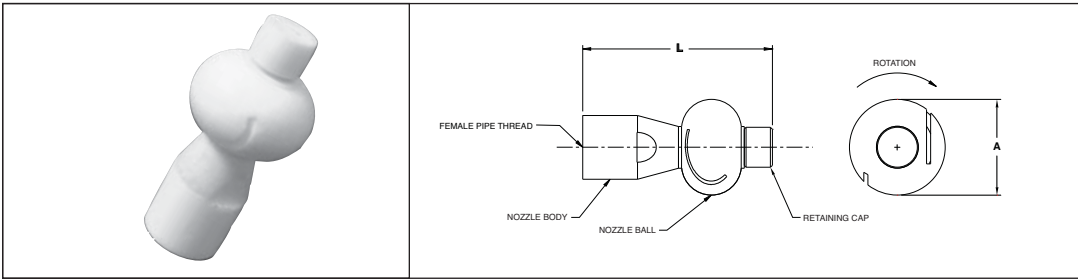

PRODUCT DESCRIPTION:

The TWK series rotating nozzles provide true 360° spray coverage in a very compact assembly. The bearing mechanism is self-lubricating and self-cleaning. This nozzle can be installed in any orientation and is effective in vessels up to 3 meters (10 feet) in diameter. The maximum recommended operating pressure is 100 psi at 180°F.

CONSTRUCTION:

This product is made from 100% Teflon®.

SPECIAL FEATURES:

- True 360° coverage
- Easy disassembly/assembly and cleaning
- FDA approved materials
- Keyed ball can not be installed backwards

TYPICAL APPLICATIONS:

- Keg Washing
- Carboy/Jug Washing
- Spray Tank Washing
- Small Tank Rinsing
- Machine Clean-In-Place (C.I.P.)
- Barrel Washing/Rinsing

U.S. Patent No. 5,316,218

Spray Coverage



TWK360xxx



TWK270xxx



TWK072xxx



TWK180xxx



TWK081xxx

OTHER NOZZLES

MODEL NUMBER	PIPE SIZE NPT FEMALE	MAXIMUM FREE PASSAGE (inches)	SANITARY TUBING SIZE*	CAPACITY (GPM) AT VARIOUS PRESSURES (psi)											SPRAY COVERAGE (degrees)	Dim. A (inches)	Dim. L (inches)	Dim. D (inches)
				5 psi	7 psi	10 psi	15 psi	20 psi	30 psi	40 psi	50 psi	60 psi	80 psi	100 psi				
1/4TWK36050	1/4	0.063	1/2	1.77	2.1	2.5	3.1	3.5	4.3	5.0	5.6	6.1	7.1	7.9	360°	1.0	2.0	3/8
1/4TWK27050	1/4	0.063	1/2	1.77	2.1	2.5	3.1	3.5	4.3	5.0	5.6	6.1	7.1	7.9	270°	1.0	2.0	3/8
1/4TWK07250	1/4	0.063	1/2	1.77	2.1	2.5	3.1	3.5	4.3	5.0	5.6	6.1	7.1	7.9	270°	1.0	2.0	3/8
1/4TWK18050	1/4	0.063	1/2	1.77	2.1	2.5	3.1	3.5	4.3	5.0	5.6	6.1	7.1	7.9	180°	1.0	2.0	3/8
1/4TWK08150	1/4	0.063	1/2	1.77	2.1	2.5	3.1	3.5	4.3	5.0	5.6	6.1	7.1	7.9	180°	1.0	2.0	3/8
3/8TWK36075	3/8	0.063	5/8	2.7	3.1	3.8	4.6	5.3	6.5	7.5	8.4	9.2	10.6	11.9	360°	1.25	2.5	3/8
3/8TWK27075	3/8	0.063	5/8	2.7	3.1	3.8	4.6	5.3	6.5	7.5	8.4	9.2	10.6	11.9	270°	1.25	2.5	3/8
3/8TWK07275	3/8	0.063	5/8	2.7	3.1	3.8	4.6	5.3	6.5	7.5	8.4	9.2	10.6	11.9	270°	1.25	2.5	3/8
3/8TWK18075	3/8	0.063	5/8	2.7	3.1	3.8	4.6	5.3	6.5	7.5	8.4	9.2	10.6	11.9	180°	1.25	2.5	3/8
3/8TWK08175	3/8	0.063	5/8	2.7	3.1	3.8	4.6	5.3	6.5	7.5	8.4	9.2	10.6	11.9	180°	1.25	2.5	3/8
1/2TWK360100	1/2	0.063	3/4	3.5	4.2	5.0	6.1	7.1	8.7	10.0	11.2	12.2	14.1	15.8	360°	1.5	2.9	3/8
1/2TWK270100	1/2	0.063	3/4	3.5	4.2	5.0	6.1	7.1	8.7	10.0	11.2	12.2	14.1	15.8	270°	1.5	2.9	3/8
1/2TWK072100	1/2	0.063	3/4	3.5	4.2	5.0	6.1	7.1	8.7	10.0	11.2	12.2	14.1	15.8	270°	1.5	2.9	3/8
1/2TWK180100	1/2	0.063	3/4	3.5	4.2	5.0	6.1	7.1	8.7	10.0	11.2	12.2	14.1	15.8	180°	1.5	2.9	3/8
1/2TWK081100	1/2	0.063	3/4	3.5	4.2	5.0	6.1	7.1	8.7	10.0	11.2	12.2	14.1	15.8	180°	1.5	2.9	3/8
3/4TWK360180	3/4	0.088	1	6.4	7.5	9.0	11.0	12.7	15.6	18.0	20	22	25	28	360°	2.0	3.9	1/2
3/4TWK270180	3/4	0.088	1	6.4	7.5	9.0	11.0	12.7	15.6	18.0	20	22	25	28	270°	2.0	3.9	1/2
3/4TWK072180	3/4	0.088	1	6.4	7.5	9.0	11.0	12.7	15.6	18.0	20	22	25	28	270°	2.0	3.9	1/2
3/4TWK180180	3/4	0.088	1	6.4	7.5	9.0	11.0	12.7	15.6	18.0	20	22	25	28	180°	2.0	3.9	1/2
3/4TWK081180	3/4	0.088	1	6.4	7.5	9.0	11.0	12.7	15.6	18.0	20	22	25	28	180°	2.0	3.9	1/2

Self-aligning disc shower nozzles

WF Series

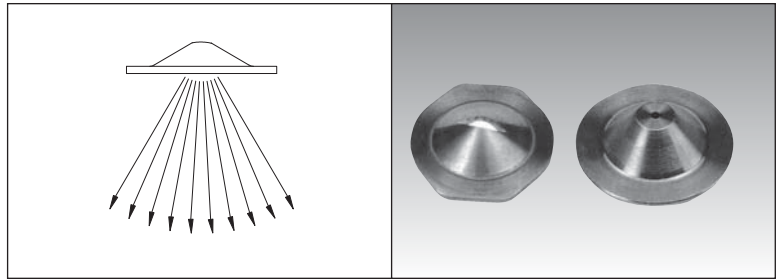
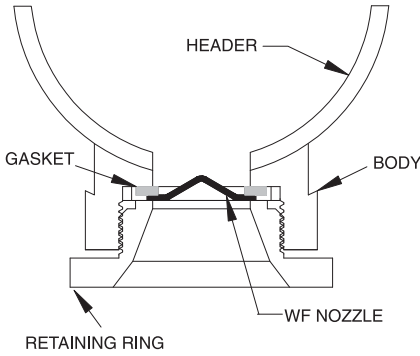

SPRAY CHARACTERISTICS:

Available in 30° and 60° flat V-shaped spray patterns, as well as zero (0) degree solid stream spray.

All flat V-shaped spray models are pre-aligned to a standard 7° offset angle to allow for spray overlap without interference from the adjacent nozzles. (Refer to drawings shown below).

CONSTRUCTION:

Standard material of construction for the spray disc is 317L stainless steel. A gasket is available for sealing the face between the nozzle disc and the body. These are also available with a ruby orifice insert. Please see page 83.

TYPICAL APPLICATIONS:

WF Series shower nozzles are designed to work in a number of commercially available "shower" bar systems where a self-aligning replaceable nozzle disc is required.

The back protruding design permits the nozzle orifice to be cleaned from inside the header, using a rotating brush.

WF FLAT STREAM NOZZLE

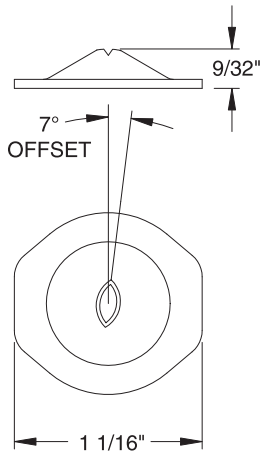

WF SOLID STREAM NOZZLE

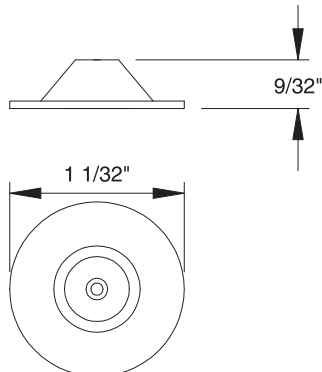

SPRAY ANGLE @ 40psi	MODEL NUMBER	CAPACITIES (GPM) AT VARIOUS PRESSURES (psi)							
		20 psi	40 psi	60 psi	80 psi	100 psi	200 psi	400 psi	600 psi
0° SOLID STREAM	WF00004	0.03	0.04	0.05	0.06	0.06	0.09	0.13	0.15
	WF00007	0.05	0.07	0.09	0.10	0.11	0.16	0.22	0.27
	WF00009	0.06	0.09	0.11	0.13	0.14	0.20	0.28	0.35
	WF0001	0.09	0.13	0.16	0.18	0.21	0.29	0.41	0.50
	WF0002	0.16	0.23	0.28	0.33	0.36	0.51	0.73	0.89
	WF0003	0.23	0.33	0.40	0.47	0.52	0.74	1.04	1.28
	WF0004	0.30	0.43	0.53	0.61	0.68	0.96	1.4	1.7
	WF0008	0.56	0.79	0.97	1.12	1.25	1.77	2.5	3.1
	WF0012	0.88	1.24	1.52	1.75	1.96	2.8	3.9	4.8
	WF0020	1.40	2.0	2.4	2.8	3.1	4.4	6.3	7.7
30°	WF3002	0.16	0.23	0.28	0.33	0.4	0.5	0.7	0.9
	WF3003	0.23	0.3	0.4	0.5	0.5	0.7	1.0	1.3
	WF3004	0.3	0.4	0.5	0.6	0.7	1.0	1.4	1.7
	WF3006	0.43	0.61	0.75	0.86	0.96	1.36	1.93	2.4
	WF3008	0.56	0.79	0.97	1.12	1.25	1.77	2.5	3.1
	WF3010	0.72	1.02	1.25	1.44	1.61	2.3	3.2	4.0
	WF3012	0.88	1.24	1.52	1.75	2.0	2.8	3.9	4.8
	WF3016	1.14	1.61	2.0	2.3	2.5	3.6	5.1	6.2
	WF3020	1.40	1.98	2.4	2.8	3.1	4.4	6.3	7.7
	60°	WF6002	0.16	0.23	0.28	0.33	0.36	0.51	0.73
WF6003		0.23	0.33	0.40	0.47	0.52	0.74	1.04	1.28
WF6004		0.30	0.43	0.53	0.61	0.68	0.96	1.36	1.67
WF6006		0.43	0.61	0.75	0.86	0.96	1.36	1.93	2.4
WF6008		0.56	0.79	0.97	1.12	1.25	1.77	2.5	3.1
WF6010		0.72	1.02	1.25	1.44	1.61	2.3	3.2	4.0
WF6012		0.88	1.24	1.52	1.75	1.96	2.8	3.9	4.8
WF6016		1.14	1.61	1.97	2.3	2.5	3.6	5.1	6.2
WF6020		1.40	1.98	2.4	2.8	3.1	4.4	6.3	7.7
WF6025		1.84	2.6	3.2	3.7	4.1	5.8	8.2	10.1
WF6031		2.2	3.1	3.8	4.4	4.9	6.9	9.8	12.0
WF6040		2.8	4.0	4.9	5.7	6.3	8.9	12.6	15.5
WF6049		3.5	4.9	6.0	6.9	7.7	11.0	15.5	19.0
WF6077		5.6	7.9	9.7	11.2	12.5	17.7	25	31
WF6099	7.0	9.9	12.1	14.0	15.7	22	31	38	
WF60124	8.8	12.4	15.2	17.5	19.6	28	39	48	

OTHER NOZZLES

WA Series

Self-cleaning shower nozzles

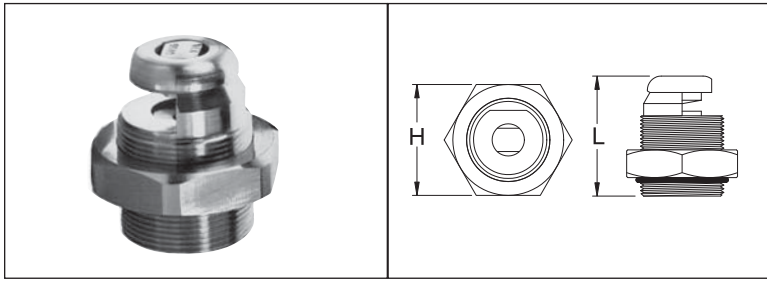

SPRAY CHARACTERISTICS:

Available in flat fan and solid stream (0 degree) models, these self-cleaning nozzles reduce shower maintenance. By reducing the supplied pressure, an internal piston retracts to purge

fibers and other suspended solids from the clogged nozzle.

CONSTRUCTION:

Standard material of construction is 316 stainless steel.

DIMENSIONS

NOZZLE TYPE	Dim. H	Dim. L
WA	1 1/2	1 5/8

TYPICAL APPLICATIONS:

- Cleaning Fabric (wire)
- Cleaning Felts
- Pre-wetting Showers
- Knock-off Showers
- Lubrication Shower

SPRAY ANGLE @ 40psi	MODEL NUMBER	CAPACITY (GPM) AT VARIOUS PRESSURES (psi)														
		20 psi	30 psi	40 psi	50 psi	60 psi	70 psi	80 psi	90 psi	100 psi	120 psi	140 psi	180 psi	200 psi	250 psi	
0° SOLID STREAM	WA0002	0.14	0.17	0.20	0.22	0.24	0.26	0.28	0.30	0.32	0.35	0.37	0.42	0.45	0.50	
	WA0006	0.42	0.52	0.60	0.67	0.73	0.79	0.85	0.90	0.95	1.04	1.12	1.27	1.34	1.50	
	WA0008	0.57	0.69	0.80	0.89	0.98	1.06	1.13	1.20	1.26	1.39	1.50	1.70	1.79	2.0	
	WA0010	0.71	0.87	1.00	1.12	1.22	1.32	1.41	1.50	1.58	1.73	1.87	2.12	2.24	2.5	
15°	WA1506	0.42	0.52	0.60	0.67	0.73	0.79	0.85	0.90	0.95	1.04	1.12	1.27	1.34	1.50	
30°	WA3005	0.35	0.43	0.50	0.56	0.61	0.66	0.71	0.75	0.79	0.87	0.94	1.06	1.12	1.25	
	WA3014	0.99	1.21	1.40	1.57	1.71	1.85	2.0	2.1	2.2	2.4	2.6	3.0	3.1	3.5	
40°	WA4012	0.85	1.04	1.20	1.34	1.47	1.59	1.70	1.80	1.90	2.1	2.2	2.5	2.7	3.0	
	WA4014	0.99	1.21	1.40	1.57	1.71	1.85	2.0	2.1	2.2	2.4	2.6	3.0	3.1	3.5	
	WA4032	2.3	2.8	3.2	3.6	3.9	4.2	4.5	4.8	5.1	5.5	6.0	6.8	7.2	8.0	
45°	WA4516	1.13	1.39	1.60	1.79	2.0	2.1	2.3	2.4	2.5	2.8	3.0	3.4	3.6	4.0	
	WA4525	1.77	2.2	2.5	2.8	3.1	3.3	3.5	3.8	4.0	4.3	4.7	5.3	5.6	6.3	
50°	WA5032	2.3	2.8	3.2	3.6	3.9	4.2	4.5	4.8	5.1	5.5	6.0	6.8	7.2	8.0	
	WA6016	1.13	1.39	1.60	1.79	2.0	2.1	2.3	2.4	2.5	2.8	3.0	3.4	3.6	4.0	
60°	WA6038	2.7	3.3	3.8	4.2	4.7	5.0	5.4	5.7	6.0	6.6	7.1	8.1	8.5	9.5	
	WA8011	0.78	0.95	1.10	1.23	1.35	1.46	1.56	1.65	1.74	1.91	2.1	2.3	2.5	2.8	
80°	WA8030	2.1	2.6	3.0	3.4	3.7	4.0	4.2	4.5	4.7	5.2	5.6	6.4	6.7	7.5	
	WA8046	3.3	4.0	4.6	5.1	5.6	6.1	6.5	6.9	7.3	8.0	8.6	9.8	10.3	11.5	
	WA11011	0.78	0.95	1.10	1.23	1.35	1.46	1.56	1.65	1.74	1.91	2.1	2.3	2.5	2.8	
110°	WA12008	0.57	0.69	0.80	0.89	0.98	1.06	1.13	1.20	1.26	1.39	1.50	1.70	1.79	2.0	
120°	WA13016	1.13	1.39	1.60	1.79	2.0	2.1	2.3	2.4	2.5	2.8	3.0	3.4	3.6	4.0	
	WA13025	1.77	2.2	2.5	2.8	3.1	3.3	3.5	3.8	4.0	4.3	4.7	5.3	5.6	6.3	

Standard thread size is 1 1/8" - 20.

OTHER NOZZLES

WN Series

Solid stream shower nozzles

SPRAY CHARACTERISTICS:

BEX WN series spray nozzles are custom designed to deliver a solid stream of liquid for high precision applications.

CONSTRUCTION:

Standard material of construction is 316 stainless steel. These are also available with a ruby insert. Please see the next page.

TYPICAL APPLICATIONS:

Uses include cleaning and washing of felts, suction rolls, fabric (wire), and other areas that require flow control and precision delivery of the nozzle stream.

MODEL NUMBER	ORIFICE DIAMETER (inches)	CAPACITY (GPM) AT VARIOUS PRESSURES (psi)							
		40 psi	60 psi	80 psi	100 psi	300 psi	600 psi	900 psi	
WN14	0.014	0.055	0.068	0.078	0.087	0.150	0.213	0.261	
WN28	0.028	0.110	0.135	0.156	0.174	0.301	0.426	0.522	
WN33	0.033	0.160	0.196	0.226	0.253	0.438	0.620	0.759	
WN40	0.040	0.230	0.282	0.325	0.364	0.630	0.891	1.091	
WN55	0.055	0.400	0.490	0.566	0.632	1.095	1.549	1.897	
WN70	0.070	0.670	0.821	0.948	1.059	1.835	2.595	3.18	
WN94	0.094	1.200	1.470	1.697	1.897	3.29	4.65	5.69	
WN125	0.125	2.000	2.449	2.828	3.16	5.48	7.75	9.49	

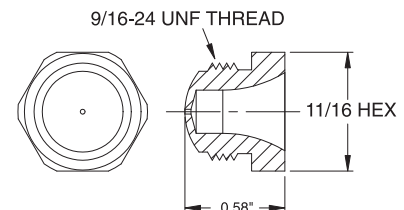

TYPICAL APPLICATIONS:

These nozzles are engineered specifically for the pulp and paper industry. The nozzles are designed to give a laminar stream of liquid at higher pressures with much higher wear resistance than the equivalent nozzles made of stainless steel.

CONSTRUCTION:

The nozzles consist of a ruby insert pressed into a 317SS housing.

Ruby Orifice Nozzles

WT Series Spray Nozzles. These trim type of spray nozzles provide a consistent solid stream of water at various pressures up to 2000 psi.

Model Number	Orifice Dia. (in)	CAPACITY AT VARIOUS PRESSURES (Gallons per Minute)									
		100 psi	200 psi	300 psi	400 psi	500 psi	600 psi	800 psi	1000 psi	1500 psi	2000 psi
WT32	0.032	0.21	0.29	0.36	0.41	0.46	0.50	0.58	0.65	0.8	0.92
WT35	0.035	0.25	0.36	0.44	0.51	0.57	0.62	0.72	0.8	0.98	1.13
WT40	0.040	0.33	0.47	0.58	0.66	0.74	0.81	0.94	1.05	1.29	1.48
WT45	0.045	0.40	0.56	0.68	0.79	0.88	0.97	1.12	1.25	1.53	1.77



WN Series Spray Nozzles. These trim type of spray nozzles provide a consistent solid stream of water at various pressures up to 800 psi. They are available in both the BEX WF disc style and the BEX WN threaded style. Standard body material is 316SS.

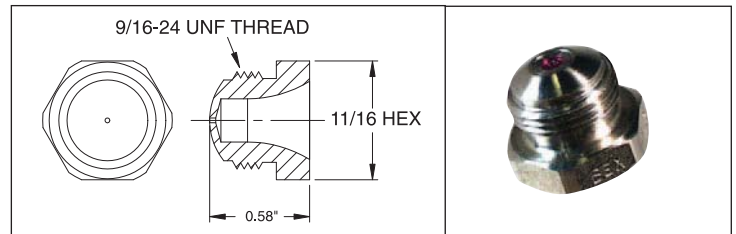

Model Number	Orifice Dia. (in)	CAPACITY AT VARIOUS PRESSURES (Gallons per Minute)								
		20 psi	40 psi	60 psi	80 psi	100 psi	250 psi	300 psi	600 psi	800 psi
WN32	0.032	0.09	0.13	0.16	0.18	0.21	0.32	0.36	0.5	0.58
WN35	0.035	0.11	0.16	0.20	0.23	0.25	0.40	0.44	0.62	0.72
WN40	0.040	0.15	0.21	0.26	0.30	0.33	0.52	0.58	0.81	0.94
WN45	0.045	0.18	0.25	0.31	0.35	0.40	0.62	0.68	0.97	1.12

WF Series Spray Nozzles. These trim type of spray nozzles provide a consistent solid stream of water at various pressures up to 800 psi. They are available in both the BEX WF disc style and the BEX WN threaded style. Standard body material is 317SS.

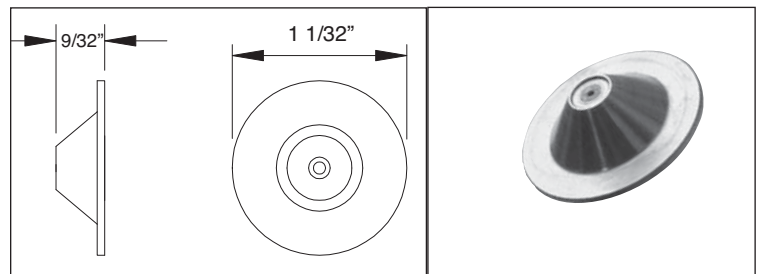

Model Number	Orifice Dia. (in)	CAPACITY AT VARIOUS PRESSURES (Gallons per Minute)								
		20 psi	40 psi	60 psi	80 psi	100 psi	250 psi	300 psi	600 psi	800 psi
WF32	0.032	0.09	0.13	0.16	0.18	0.21	0.32	0.36	0.5	0.58
WF35	0.035	0.11	0.16	0.20	0.23	0.25	0.40	0.44	0.62	0.72
WF40	0.040	0.15	0.21	0.26	0.30	0.33	0.52	0.58	0.81	0.94
WF45	0.045	0.18	0.25	0.31	0.35	0.40	0.62	0.68	0.97	1.12

OTHER NOZZLES

MAJ Series

Retaining cap style adjustable joints

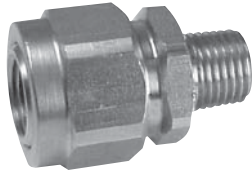

TYPICAL APPLICATIONS:

The MAJ series of adjustable joints allow spray nozzles or other threaded items to be rotated and tilted to obtain the desired spray pattern or orientation, without having to disturb the surrounding piping. They may also be used within piping systems as an adjustable union type connection.

CONSTRUCTION:

The unit consists of a male inlet section and a female outlet section, held together by a threaded cap. The cap may be loosened to change the angle of adjustment between the inlet and outlet sections. Maximum recommended operating pressure is 300 psi. Standard materials are brass, 303 stainless steel, and 316 stainless steel.

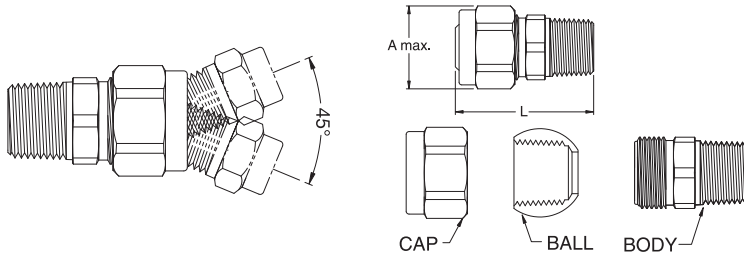

DIMENSIONS

MODEL NUMBER	Inlet Pipe Size NPT	Outlet Pipe Size NPT	Dim. A (max) (inches)	Dim. L (max) (inches)
¹ / ₈ MAJ	¹ / ₈ male	¹ / ₈ female	0.97	1.4
¹ / ₄ MAJ	¹ / ₄ male	¹ / ₄ female	1.1	1.6
³ / ₈ MAJ	³ / ₈ male	³ / ₈ female	1.4	1.8
¹ / ₂ MAJ	¹ / ₂ male	¹ / ₂ female	1.7	2.2
³ / ₄ MAJ	³ / ₄ male	³ / ₄ female	1.9	2.6

Other combinations are available.

AJ Series

Flanged adjustable joints

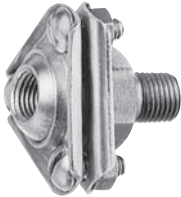

TYPICAL APPLICATIONS:

To rotate and tilt spray nozzles, to obtain a desired positioning of a spray pattern, without having to disturb surrounding piping. May also be used within piping systems as an adjustable union type connection. Maximum recommended operating pressure is 120 p.s.i.

CONSTRUCTION:

The unit consists of a male inlet section and a female outlet section, held together by a flange assembly. Locking screws may be loosened to change the angle of adjustment between the inlet and outlet sections. Standard materials are brass and 303 or 316 stainless steel with 304 stainless steel flanges.

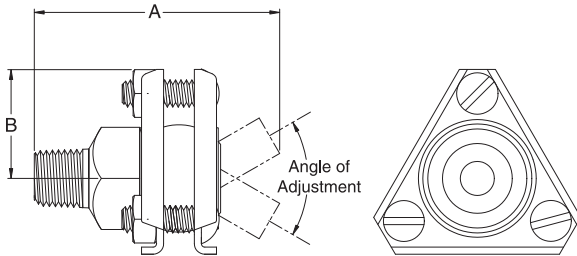

Inlet of ball is hexagonal for easy holding

DIMENSIONS (inches)

MODEL NUMBER	INLET PIPE SIZE	OUTLET PIPE SIZE	Dim. A (inches)	Dim. B (inches)	Maximum Angle of Adjustment
¹ / ₈ x ¹ / ₈ AJ	¹ / ₈ male	¹ / ₈ female	1 ³ / ₄	1	60°
¹ / ₄ x ¹ / ₈ AJ	¹ / ₄ male	¹ / ₈ female	1 ³ / ₄	1	60°
¹ / ₄ x ¹ / ₄ AJ	¹ / ₄ male	¹ / ₄ female	1 ³ / ₄	1	60°
³ / ₈ x ¹ / ₄ AJ	³ / ₈ male	¹ / ₄ female	1 ³ / ₄	1	60°
³ / ₈ x ³ / ₈ AJ	³ / ₈ male	³ / ₈ female	1 ³ / ₄	1	45°
¹ / ₂ x ¹ / ₂ AJ	¹ / ₂ male	¹ / ₂ female	2 ¹ / ₂	1 ¹ / ₂	50°
¹ / ₈ x ³ / ₄ AJ	¹ / ₈ male	³ / ₄ female	2 ¹ / ₂	1 ¹ / ₂	50°
³ / ₄ x ¹ / ₂ AJ	³ / ₄ male	¹ / ₂ female	2 ⁵ / ₈	1 ¹ / ₂	50°
³ / ₄ x ³ / ₄ AJ	³ / ₄ male	³ / ₄ female	2 ⁵ / ₈	1 ¹ / ₂	40°

K-Ball® Clip-ons as Adjustable Joints

Use the threaded or clip-on K-Ball® to "tilt" the spray pattern into almost any desired orientation.

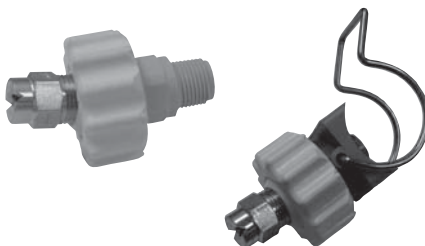

Ball has a hexagonal interior for easy holding

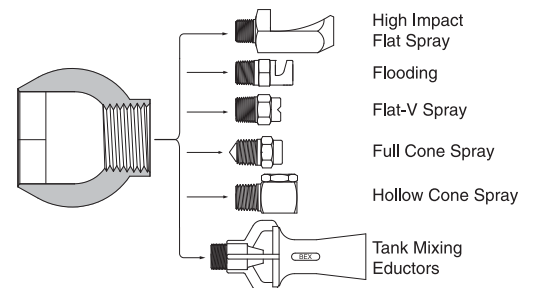
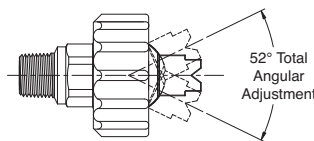

High impact flat spray nozzles

SN4224 Series



TYPICAL APPLICATIONS:

SN4224 is a specially designed spray nozzle that provides high impact per unit area. This flat spray nozzle works particularly well for screen-filters, pulp “knock-off” showers and

other applications where loose scale and debris removal are required.

CONSTRUCTION:

SN4224 is available in 316 stainless steel with an 1/8” orifice and a 3/8” NPT male fitting

MODEL NUMBER	ORIFICE DIAMETER (inches)	CAPACITY (GPM) AT VARIOUS PRESSURES (psi)				
		20 psi	40 psi	60 psi	80 psi	100 psi
SN4224	0.125	2.1	2.9	3.6	4.1	4.6

All references to G.P.M. mean U.S. G.P.M.

Check Valves



TYPICAL APPLICATIONS:

Check valves are used in line with many spray nozzles when the application requires the complete shut-off of flow while maintaining full line pressure. The spring loaded ball-type design provides a drip-free seal with shut-off pressures of 5, 10 and 20 psi.

CONSTRUCTION:

The unit consists of a two-piece body, an internal spring and a shut-off stainless steel ball. Available in 1/8”, 1/4”, 3/8” and 1/2” NPT sizes. Standard materials are brass, 303SS and 316SS.

SHUT OFF PSI	MODEL NUMBER			
Length (Inches)	1-13/16	2-5/16	2-5/16	3-1/2
5	1/8CV5	1/4CV5	3/8CV5	1/2CV5
10	1/8CV10	1/4CV10	3/8CV10	1/2CV10
20	1/8CV20	1/4CV20	3/8CV20	1/2CV20

Split Eyelets

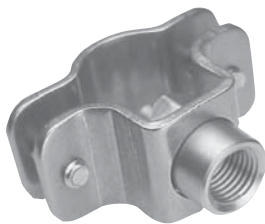

TYPICAL APPLICATIONS:

Anywhere an alternate connection to pipe is desired. Eliminates:

- Threading
- Brazing
- Welding

CONSTRUCTION:

The split eyelet consists of a top and bottom clamp, two retaining bolts, an outlet body and an O-ring. Clamps and retaining bolts are zinc-plated steel. Standard materials for the body are brass, 303 stainless steel and 316 stainless steel. The O-ring seal is Buna-N.

PIPE SIZE	MODELS (NPT OUTLET SIZE)			MAX. FLOW	DRILL SIZE
	1/8	1/4	3/8		
1/2	1/2x1/8FSE	1/2x1/4FSE		3.5 GPM	9/32 DRILL
3/4	3/4x1/8FSE	3/4x1/4FSE		3.5 GPM	9/32 DRILL
1	1x1/8FSE	1x1/4FSE		3.5 GPM	9/32 DRILL
1-1/4	1-1/4x1/8FSE	1-1/4x1/4FSE	1-1/4x3/8FSE	19 GPM	11/16 DRILL
1-1/2	1-1/2x1/8FSE	1-1/2x1/4FSE	1-1/2x3/8FSE	19 GPM	11/16 DRILL
2	2x1/8FSE	2x1/4FSE	2x3/8FSE	19 GPM	11/16 DRILL
2-1/2	2-1/2x1/8FSE	2-1/2x1/4FSE	2-1/2x3/8FSE	19 GPM	11/16 DRILL

STA Series

Flow stabilizers

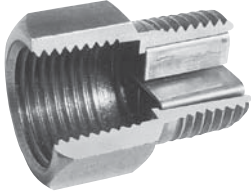

TYPICAL APPLICATIONS:

When liquid in a pipe emerges from elbows or tees, the resulting flow is often distorted. These flow stabilizers help to eliminate flow distortion, resulting in a more even and consistent spray pattern.

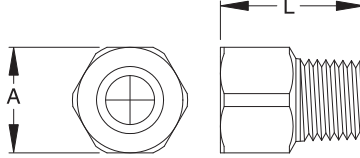

CONSTRUCTION:

This unit consists of a body and an internal vane. Available in 1/8", 1/4", 3/8" and 1/2" NPT sizes, with a male inlet and female outlet connection. Standard materials are brass, 303 and 316 stainless steel.

DIMENSIONS

MODEL NUMBER	Inlet Pipe Size NPT	Outlet Pipe Size NPT	Dim. A (inches)	Dim. L (inches)
1/8 STA	1/8 male	1/8 female	9/16 HEX	7/8
1/4 STA	1/4 male	1/4 female	11/16 HEX	1
3/8 STA	3/8 male	3/8 female	13/16 HEX	1 1/8
1/2 STA	1/2 male	1/2 female	1 HEX	1 3/8

AW Series

Airwisk™ Blow-off nozzles

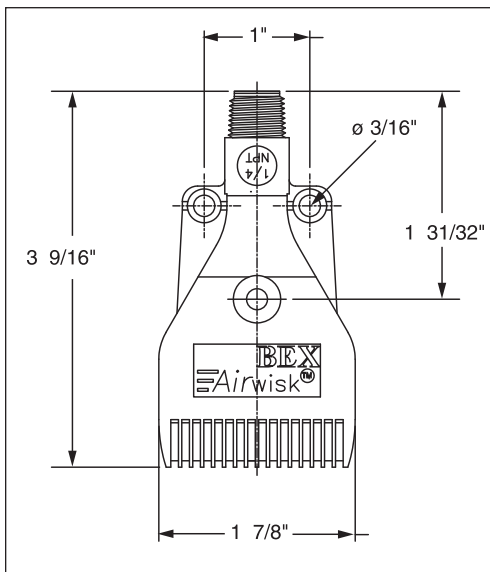

SPRAY CHARACTERISTICS:

BEX Airwisk nozzles produce a concentrated flat fan pattern of high impact air for cooling, drying and blow off applications. The Airwisk's design efficiently controls compressed air usage, reduces energy costs and provides optimum air distribution.

CONSTRUCTION:

The BEX Airwisk is made of hard-wearing ABS plastic (rated to 150° F) and has a maximum pressure of 100 PSIG. The Airwisk can be mounted individually or side by side to provide greater coverage.



TYPICAL APPLICATIONS:

- Cooling of Components/Parts
- Cleaning and Drying of Parts
- Air Curtains
- Debris Removal

CAPACITIES

MODEL NUMBER	Thread Size (NPT)	CAPACITY (SCFM) AT VARIOUS PRESSURES (psi)				
		10 psi	30 psi	40 psi	60 psi	90 psi
1/4AW15	1/4"	6.5	12.3	15.0	20.5	28.7

SN4922

Clean in place nozzle

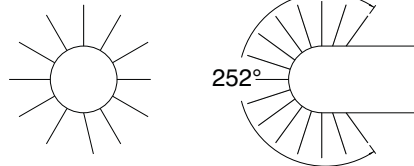
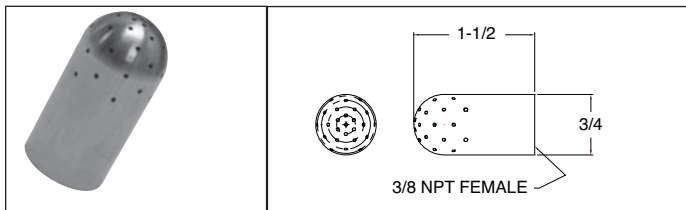

WATER CAPACITIES

MODEL NUMBER	CAPACITIES (GPM) AT VARIOUS PRESSURES (psi)							
	10 psi	20 psi	30 psi	40 psi	60 psi	80 psi	100 psi	150 psi
SN4922	4.6	6.5	8.0	9.2	11.3	13.0	14.6	17.8

AIR CAPACITIES

MODEL NUMBER	Thread Size (NPT)	CAPACITY (SCFM) AT VARIOUS PRESSURES (psi)				
		10 psi	20 psi	30 psi	60 psi	90 psi
SN4922	1/4"	14.2	21.1	27.3	46	63.9

Air Atomizing Nozzles



JPL Series Air Atomizing Spray Nozzles

BEX JPL Air Atomizing Spray Nozzles use compressed air (or gas) to produce an accurately controlled liquid dispersion in applications where a conventional liquid spray nozzle would not be suitable.

Typical applications include humidification, cooling, air pollution control, coating processes, lubrication, curing, chemical dispersion, and many other uses.

The JPL Series are excellent products for new applications, and are suitable for replacing products in existing atomizing applications. Many of the JPL Series components are interchangeable with products from other manufacturers.

Typical Applications

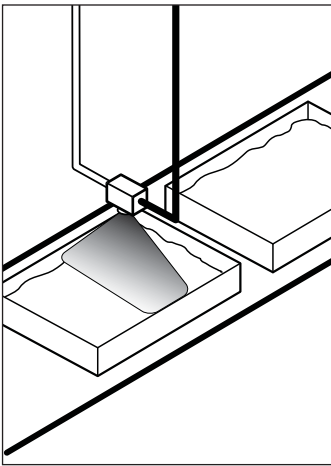

Vitamin/Bacteriostat liquid accurately spray portioned on animal feed.

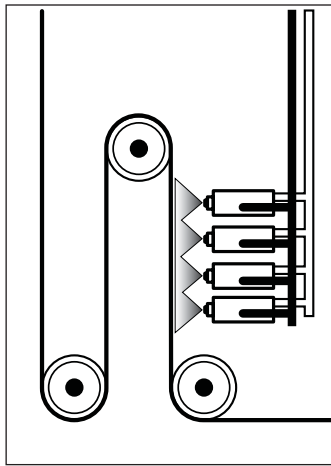

Moisturizing, anti-static application on fabric.

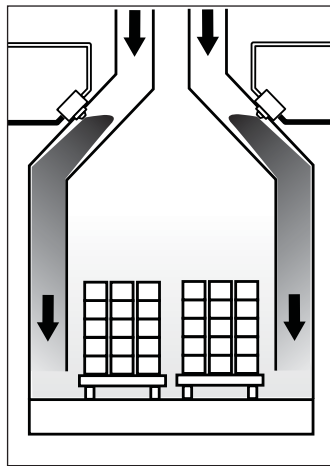

Humidity control in curing ovens, kilns and furnaces.

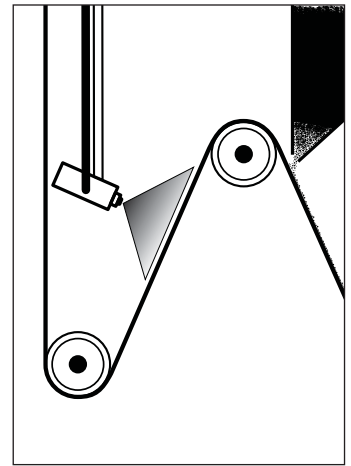

Adhesive application to paper prior to abrasive coating.

What is a Standard JPL Assembly?



BEX JPL Series Air Atomizing Nozzle with standard 1/4" x 1/4" NPT JPL body. (Other body styles available, see pages 98 & 99.)

BEX offers a full complement of special body connections, wall mounts, shut-off needles, automatic body styles, etc: pages 98-99.



A standard BEX JPL assembly consists of seven (7) components that fit together to produce an atomized liquid spray pattern.

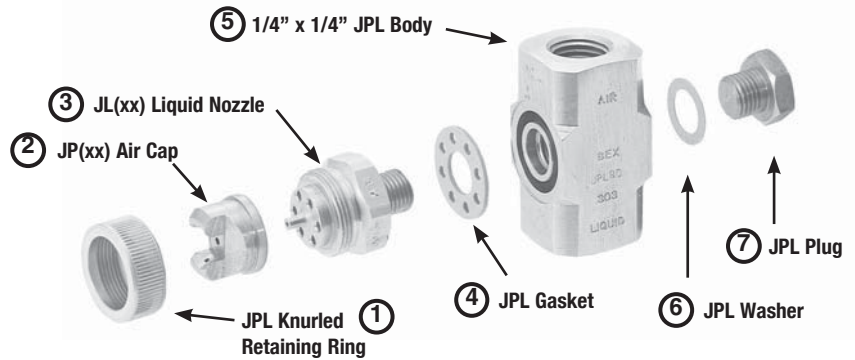

The JP Air Cap ② and JL Liquid Nozzle ③ are the components that actually determine the spray pattern and liquid/air flow rates. We have arranged many of these Air Caps and Liquid Nozzles into a “set-up” (see pages 90-97), which makes it much easier to select a suitable choice for your application.

BEX “JPL” series nozzles and components are available in 303 stainless steel, 316 stainless steel and nickel-plated brass (note: only the external/appearance surfaces of brass components are nickel-plated; see page 101 for more information).

How to Select a Set-up

All BEX "JPL" Series products are designed to provide a wide range of performance flexibility, allowing the user to adjust the liquid and air feed to the set-up.

By adjusting the liquid and/or air source, a variety of spray droplets and

atomization can be obtained. The performance tables that follow provide spray capacities at certain liquid/air flow combinations for water under standard conditions. These are not by any means the only possible results for each specific set-up.

Quick Reference

If you know how much liquid flow you desire from the nozzle, but are unsure of the other operating parameters, the tables below provide a quick starting point to determine which set-ups are most frequently chosen to provide the liquid flow rate desired.

FLAT SPRAY MODEL SET-UP NO.

GPH*	PRESSURE FED LIQUID	SIPHON FED LIQUID
0.0-0.5	JPL - E15B, E18B, 14, N13	JPL - F1, F2C
0.5-1.0	JPL - E15B, E18B, 14, N13, 13A, 13	JPL - F2C, F3B
1.0-1.5	JPL - E15B, E18B, 14, N13, 13A, 13, E15A, E18A, N23, 23B	JPL - F3B, F4B
1.5-2.5	JPL - E15B, E18B, 14, N13, 13A, 13, E15A, E18A, E15, E18, N23, 23B	JPL - F4B
2.5-3.5	JPL - E15B, E18B, 14, N13, 13A, 13, E15A, E18A, E15, E18, N23, 23B, 23	
3.5-6.0	JPL - E15, E18, E25B, N13, E28B, 12, E15A, E18A, E25A, E28A, N23, 23B, 23	
6.0-9.0	JPL - E15, E18, E25B, 23B, E28B, E28B, 43, E25A, E28A, N23, 23	
9.0-13	JPL - E25, E45B, E25B, E28, E28B, 43, 23, N23, E25A, E28A	
13-20	JPL - E25, E45B, E25B, E28, E28B, 43, 23, N23, E25A, E28A, E45A	
20-30	JPL - E25, E45B, E45, E28, E45A, 43	
30-50	JPL - E25, 43, E45, E28, E45A	
50-70	JPL - E45	
over 70	Please contact your BEX representative	

ROUND SPRAY MODEL SET-UP NO.

GPH*	PRESSURE FED LIQUID	SIPHON FED LIQUID
0.0-0.5	JPL - 11, 12A, 16	JPL - 1, 1A, 2A
0.5-1.0	JPL - 11, 12A, 12, 22B, 16, 26B	JPL - 1, 2A, 2
1.0-1.5	JPL - 11, 12A, 12, 22B, 16, 26B, 30	JPL - 2
1.5-2.5	JPL - 11, 12A, 12, 22B, 16, 26B, 26, 30	JPL - 4
2.5-3.5	JPL - 12A, 12, 22B, 16, 26B, 26, 29, 30, 46	JPL - 4, 5
3.5-6.0	JPL - 12, 22B, 22, 26B, 26, 29, 30, 46	JPL - 4, 5
6.0-9.0	JPL - 22B, 22, 26B, 26, 29, 46	JPL - 4, 5
9.0-13	JPL - 22, 26, 29, 42, 46	JPL - 5
13-20	JPL - 22, 26, 29, 42, 46	
20-30	JPL - 22, 42, 46	
30-50	JPL - 42	
50-70	JPL - 42	
over 70	Please contact your BEX Representative	

For detailed performance data please refer to the tables on the following pages.

Choice of Spray Set-ups

Each spray set-up consists of an air cap and liquid cap which provide a specific spray pattern, capacity and coverage performance. The set-up will produce

comparable spray performance with any of the various bodies available.

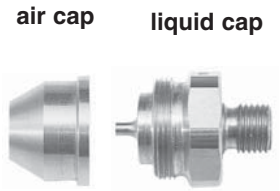

Internal Mix

Liquid and gas are mixed internally to produce a completely atomized spray. Available in Round, Wide-Angle Round and Flat Spray patterns.

Common uses: Dust control, pesticide application, humidification, cooling, coating and low viscosity fluids.

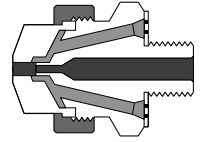

External Mix

Liquid atomization is controlled by varying the air pressure without changing the liquid pressure. Effective for higher viscosity liquids and abrasive suspensions.

Common uses: Precisely metered applications, adhesives, coatings and viscous fluids.

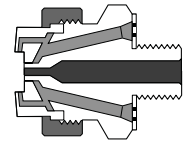

Basic Nozzle Installations

Fine or coarse droplet size atomization is produced by adjusting the air and liquid pressures. Finer atomization is achieved

by increasing air pressure and/or lowering the liquid pressure.

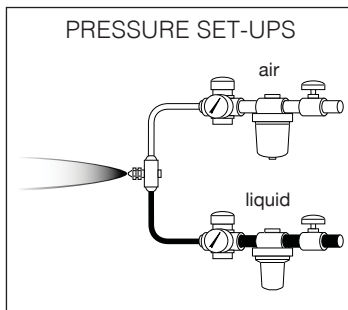

The liquid is supplied to the nozzle under pressure. Air and liquid can be externally or internally mixed to produce the proper atomized spray.

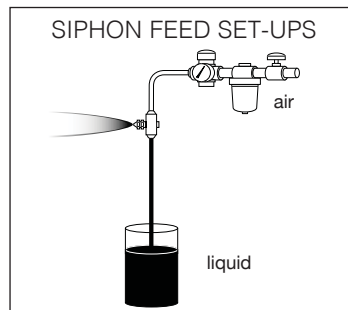

The liquid is supplied by either a liquid siphon or gravity feed. These set-ups are designed to draw liquid through the feed line into the air flow where it is properly atomized.

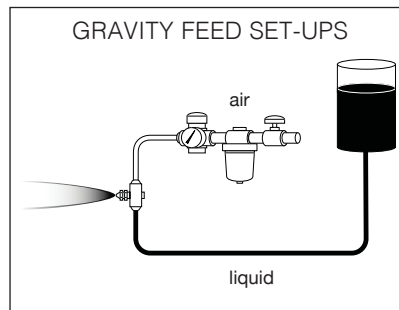

BEX JPE Series Round Spray

Pressure feed - Internal mix

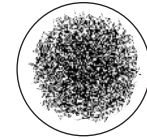
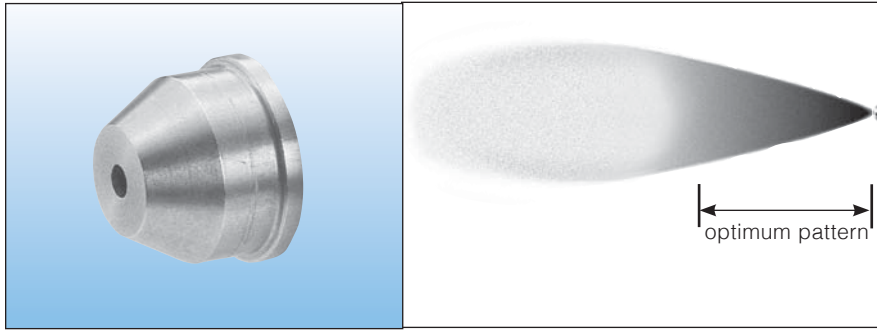

Spray Pattern

APPLICATION AND PERFORMANCE

Set-ups with BEX JPG series air caps produce a round spray pattern. The liquid is pressure fed and internally mixed. Nozzle selection is not limited for other parameters.

JPE Round Spray Performance Chart

BEX Set-up No.	Spray Set-up consists of Liquid and Air Cap Combination	Liquid Capacity in GPH and Air Capacity in SCFM															Spray Dimensions		
		Liquid Pressure in psi															Optimum Pattern		Maximum Spray Range feet
		10 psi			20 psi			30 psi			40 psi			60 psi			Spray Angle degrees	Spray Range inches	
Air Press psi	GPH	SCFM	Air Press psi	GPH	SCFM	Air Press psi	GPH	SCFM	Air Press psi	GPH	SCFM	Air Press psi	GPH	SCFM					
JPL11	Liquid Cap JL2050 + Air Cap JPE20	10	.55	.55	14	1.50	.40	24	1.68	.56	32	1.86	.68	50	2.28	.98	13-15	12-17	9-14
		12	.67	.67	18	1.23	.50	28	1.44	.63	36	1.62	.80	54	2.05	1.07			
		14	.78	.78	22	.99	.63	32	1.08	.82	40	1.32	.93	58	1.80	1.19			
		--	--	--	24	.86	.70	36	.84	.96	44	1.08	1.07	62	1.56	1.36			
		--	--	--	26	.72	.76	38	.72	1.03	48	.85	1.23	66	1.32	1.52			
JPL12A	Liquid Cap JL2050 + Air Cap JPE40	10	.66	.66	18	1.44	.87	1	1.98	1.00	30	2.40	1.14	40	3.30	1.36	12-15	17-22	12-17
		12	.77	.77	20	1.32	.98	28	1.68	1.17	34	2.16	1.29	46	2.94	1.54			
		14	.90	.90	22	1.20	1.06	32	1.44	1.35	38	1.92	1.47	52	2.58	1.83			
		--	--	--	24	1.01	1.16	34	1.32	1.46	42	1.62	1.68	58	2.28	2.09			
		--	--	--	26	.90	1.26	36	1.20	1.57	44	1.50	1.78	62	2.10	2.26			
JPL12	Liquid Cap JL2850 + Air Cap JPE40	12	1.26	.73	22	2.16	1.05	30	2.90	1.24	36	4.32	1.26	48	5.82	1.50	12-15	19-23	13-17
		16	1.08	.94	26	1.74	1.23	34	2.46	1.42	40	3.85	1.36	52	5.28	1.65			
		20	.90	1.15	30	1.44	1.47	38	2.10	1.65	44	3.55	1.56	56	4.92	1.73			
		22	.81	1.25	34	1.26	1.67	42	1.74	1.87	48	2.80	1.78	60	4.56	1.88			
		24	.78	1.36	38	1.08	1.87	46	1.50	2.03	52	2.46	2.01	64	4.08	2.08			
JPL22B	Liquid Cap JL40100 + Air Cap JPE60	26	.77	1.43	40	1.02	1.96	50	1.24	2.25	56	2.16	2.20	68	3.72	2.25	18-21	26-38	16-30
		28	.76	1.56	42	.94	2.04	52	1.20	2.36	60	1.86	2.36	70	3.60	2.34			
		16	3.44	2.68	28	5.03	3.71	40	6.10	4.72	48	7.75	5.30	65	10.7	6.74			
		20	2.35	3.20	32	3.70	4.17	44	5.03	5.17	55	5.95	6.07	75	8.7	7.73			
		22	1.90	3.46	36	2.64	4.65	48	3.95	5.65	65	3.55	7.28	80	7.65	8.25			
JPL22	Liquid Cap JL60100 + Air Cap JPE60	24	1.54	3.70	40	1.85	5.13	55	2.30	6.50	75	1.95	8.50	85	6.65	8.80	17-21	24-36	16-28
		26	1.23	3.97	44	1.30	5.63	60	1.56	7.12	80	1.40	9.10	90	5.64	9.40			
		28	.96	4.22	48	.90	6.10	65	1.08	7.75	85	1.00	9.70	95	4.63	10.0			
		30	.72	4.48	50	.76	6.36	70	.73	8.35	90	.72	10.3	100	3.62	10.6			
		12	8.1	2.00	20	13.6	2.55	30	16.3	3.25	38	19.5	3.74	54	25.7	4.66			
JPL42	Liquid Cap JL100150 + Air Cap JPE80	14	6.60	2.32	22	12.0	2.85	34	13.1	3.75	42	16.5	4.20	60	21.8	5.34	19-22	35-46	20-30
		16	4.90	2.66	24	10.2	3.15	38	9.9	4.32	46	13.6	4.71	65	18.5	5.98			
		18	3.40	3.00	26	8.6	3.45	40	8.0	4.61	50	10.8	5.30	70	15.2	6.68			
		--	--	--	28	7.20	3.75	42	7.60	4.90	52	9.6	5.80	75	12.2	7.80			
		--	--	--	30	5.90	4.05	44	6.60	5.20	54	8.6	5.85	80	10.0	8.14			
JPL42	Liquid Cap JL100150 + Air Cap JPE80	--	--	--	32	4.60	4.35	46	5.60	5.50	56	7.60	6.14	85	8.0	8.90	19-22	35-46	20-30
		14	11.7	3.05	20	27.5	3.04	28	36.6	3.55	32	49.4	3.31	42	70.6	3.17			
		16	8.5	3.60	22	23.0	3.49	30	32.6	3.96	36	42.2	4.10	46	65.0	3.85			
		--	--	--	24	18.0	3.95	32	28.7	4.36	40	35.1	4.90	50	59.0	4.63			
		--	--	--	26	14.4	4.40	34	24.8	4.78	44	28.0	5.66	54	53.2	5.40			
JPL42	Liquid Cap JL100150 + Air Cap JPE80	--	--	--	28	11.3	4.85	36	20.9	5.20	46	24.5	6.05	58	47.4	6.16	19-22	35-46	20-30
		--	--	--	--	--	--	38	17.5	5.60	48	21.3	6.45	65	37.8	7.54			
		--	--	--	--	--	--	40	14.6	6.03	50	18.4	6.86	70	30.0	8.55			

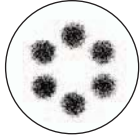

Spray Pattern

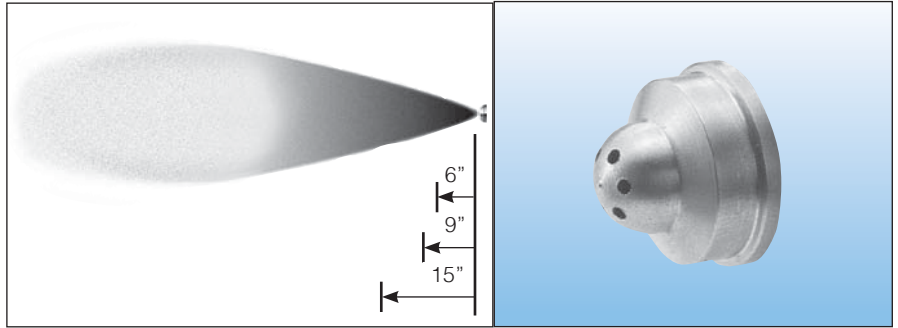

APPLICATION AND PERFORMANCE

Set-ups with BEX JPE series air caps produce a wide-angle round spray pattern. The liquid is pressure fed and internally mixed. Nozzle selection is not limited for other parameters.

JPG Wide Angle Round Spray Performance Chart

BEX Set-up No.	Spray Set-up consists of Liquid and Air Cap Combination	Liquid Capacity in GPH and Air Capacity in SCFM															Spray Dimensions				
		Liquid Pressure in psi															Pattern Width in Inches			Maximum Spray Range Feet	
		10 psi			20 psi			30 psi			40 psi			60 psi			6" from tip	9" from tip	15" from tip		
Air Press psi	GPH	SCFM	Air Press psi	GPH	SCFM	Air Press psi	GPH	SCFM	Air Press psi	GPH	SCFM	Air Press psi	GPH	SCFM	Air Press psi	GPH	SCFM				
JPL16	Liquid Cap JL2050 + Air Cap JPG15	8	1.41	.36	14	2.10	.42	22	2.36	.56	30	2.53	.68	44	2.95	.81					
		10	1.14	.43	16	1.90	.50	26	2.02	.69	34	2.23	.81	48	2.72	.94					
		12	.79	.50	18	1.68	.56	30	1.61	.83	38	1.90	.94	55	2.30	1.20					
		14	.45	.60	20	1.44	.64	34	1.15	1.00	42	1.50	1.10	60	1.92	1.40					
		--	--	--	22	1.17	.71	36	.91	1.07	46	1.10	1.26	65	1.50	1.60					
JPL26B	Liquid Cap JL40100 + Air Cap JPG60	--	--	--	24	.91	.80	38	.68	1.16	48	.90	1.35	70	1.07	1.80					
		--	--	--	26	.55	.90	40	.43	1.25	50	.69	1.45	75	.65	2.05					
		12	1.85	1.78	22	3.30	2.30	30	5.10	2.54	38	6.40	2.84	54	8.8	3.44					
		14	.55	2.20	24	2.20	2.67	32	4.25	2.85	42	4.70	3.42	56	8.1	3.74					
		--	--	--	26	1.20	3.05	34	3.35	3.18	44	3.90	3.72	58	7.44	4.03					
JPL26	Liquid Cap JL60100 + Air Cap JPG60	--	--	--	--	--	--	36	2.50	3.50	46	3.06	4.05	60	6.76	4.32					
		--	--	--	--	--	--	38	1.60	3.85	48	2.25	4.42	65	5.10	5.10					
		--	--	--	--	--	--	40	.70	4.30	50	1.40	4.84	70	3.50	6.00					
		--	--	--	--	--	--	--	--	--	52	.60	5.34	75	1.85	6.95					
		10	6.30	1.14	20	9.0	1.60	30	11.2	2.04	40	12.4	2.54	56	16.2	2.75					
JPL29	Liquid Cap JL60100 + Air Cap JPG45	12	3.60	1.54	22	6.90	2.00	32	9.3	2.44	42	10.6	2.92	58	14.8	3.11					
		14	2.00	2.00	24	5.10	2.40	34	7.40	2.80	44	8.8	3.33	60	13.8	3.50					
		--	--	--	26	3.30	2.80	36	5.40	3.20	46	7.10	3.72	65	9.8	4.42					
		--	--	--	--	--	--	38	3.60	3.60	48	5.40	4.14	70	6.50	5.36					
		--	--	--	--	--	--	40	2.30	3.98	50	3.60	4.51	75	4.00	6.31					
JPL30	Liquid Cap JL40100 + Air Cap JPG30	--	--	--	--	--	--	--	--	52	2.20	4.91	80	2.40	6.51						
		18	9.4	3.00	30	13.4	4.15	44	15.3	5.45	60	15.6	7.05	80	21.4	8.55					
		22	7.70	3.60	34	11.9	4.65	48	13.8	5.90	70	12.5	8.25	85	19.5	9.15					
		26	6.00	4.13	38	10.3	5.10	55	11.3	6.75	80	9.3	9.45	90	17.9	9.75					
		28	5.20	4.40	42	8.9	5.60	65	7.80	8.00	85	7.80	10.1	95	16.5	10.4					
JPL46	Liquid Cap JL100150 + Air Cap JPG75	30	4.40	4.70	46	7.30	6.10	70	6.10	8.60	90	6.20	10.7	100	15.1	11.0					
		32	3.70	5.00	50	5.80	6.65	75	4.50	9.25	95	4.80	11.3	--	--	--					
		34	3.00	5.25	60	2.40	7.95	80	3.30	9.85	100	3.70	11.9	--	--	--					
		16	3.24	1.43	28	4.60	1.96	42	5.27	2.67	55	5.69	3.30	80	7.10	4.50					
		18	2.61	1.59	32	3.37	2.27	46	4.00	2.96	60	4.24	3.68	85	5.80	4.88					
JPL46	Liquid Cap JL100150 + Air Cap JPG75	20	2.08	1.75	36	2.45	2.55	48	3.45	3.11	65	3.15	4.06	90	4.65	5.27					
		22	1.62	1.90	40	1.75	2.85	50	3.03	3.26	70	2.31	4.44	95	3.75	5.65					
		24	1.30	2.06	42	1.45	3.00	55	2.11	3.63	75	1.72	4.82	100	3.00	6.03					
		26	1.04	2.20	44	1.21	3.14	60	1.47	3.98	80	1.32	5.20	--	--	--					
		28	.82	2.35	46	1.00	3.28	65	1.03	4.36	85	1.05	5.58	--	--	--					
JPL46	Liquid Cap JL100150 + Air Cap JPG75	24	6.70	5.50	38	10.7	7.40	48	16.5	8.80	60	18.6	10.4	85	29.2	13.7					
		26	5.20	5.90	42	7.60	8.30	52	12.5	9.60	65	13.7	11.4	90	24.6	14.7					
		28	4.00	6.30	44	6.20	8.70	56	9.2	10.4	70	10.0	12.4	95	20.7	15.8					
		30	3.00	6.80	46	5.00	9.10	60	6.60	11.3	75	7.40	13.5	100	17.5	16.9					
		32	2.00	7.20	48	4.00	9.50	62	5.60	11.7	80	5.50	14.5	--	--	--					
--	--	--	50	3.00	9.90	65	4.40	12.3	85	4.00	15.5	--	--	--							
--	--	--	52	2.40	10.3	70	2.60	13.3	90	2.50	16.6	--	--	--							

BEX JPD Series Flat Spray

Pressure feed - Internal mix

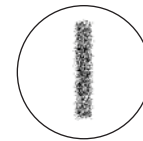
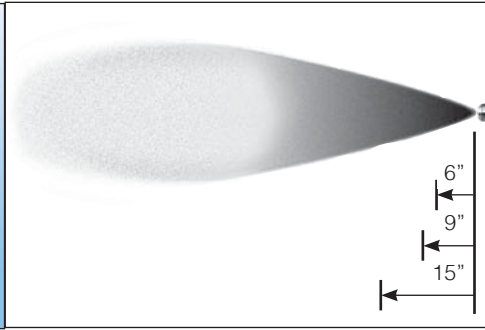
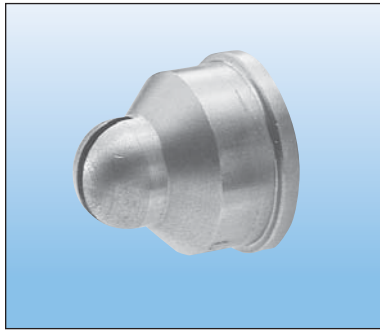

Spray Pattern

APPLICATION AND PERFORMANCE

Set-ups with BEX JPD series air caps produce a flat spray pattern. The liquid is pressure fed and internally mixed. Nozzle selection is not limited for other parameters.

JPD Round Spray Performance Chart

BEX Set-up No.	Spray Set-up consists of Liquid and Air Cap Combination	Liquid Capacity in GPH and Air Capacity in SCFM															Spray Dimension				
		Liquid Pressure in psi															Pattern Width in Inches				Maximum Spray Range feet
		10 psi			20 psi			30 psi			40 psi			60 psi			6" from tip	9" from tip	15" from tip		
Air Press psi	GPH	SCFM	Air Press psi	GPH	SCFM	Air Press psi	GPH	SCFM	Air Press psi	GPH	SCFM	Air Press psi	GPH	SCFM	Air Press psi	GPH	SCFM				
JPL13A	Liquid Cap JL2050 + Air Cap JPD30	10	1.44	.84	18	2.17	1.12	28	2.49	1.47	38	2.77	1.84	55	3.41	2.43	10-22	14-29	18-37	8-13	
		12	1.25	.96	22	1.82	1.31	32	2.19	1.64	42	2.49	2.01	65	2.83	2.85					
		14	1.09	1.08	26	1.50	1.50	36	1.89	1.82	46	2.20	2.19	75	2.26	3.26					
		16	.93	1.20	30	1.20	1.68	40	1.58	2.00	50	1.93	2.37	85	1.69	3.67					
		18	.79	1.32	34	.93	1.87	44	1.30	2.18	60	1.25	2.81	90	1.40	3.88					
JPL13	Liquid Cap JL2850 + Air Cap JPD30	20	.65	1.43	38	.68	2.07	48	1.03	2.36	65	.93	3.02	95	1.13	4.09	14-23	18-30	28-38	7-10	
		22	.53	1.55	40	.57	2.16	55	.65	2.68	70	.65	3.25	100	.88	4.29					
		12	2.17	.70	20	3.35	.96	30	3.98	1.27	38	4.66	1.49	65	4.80	2.38					
		14	1.80	.82	24	2.71	1.14	34	3.41	1.45	42	4.14	1.65	70	4.21	2.62					
		16	1.45	.95	28	2.06	1.34	38	2.85	1.64	46	3.60	1.85	75	3.63	2.86					
JPLN13	Liquid Cap JL2850 + Air Cap JPD45	18	1.08	1.07	30	1.76	1.45	42	2.29	1.85	50	3.08	2.05	80	3.05	3.10	4-8	5-10	7-13	10-16	
		20	.77	1.20	32	1.44	1.56	46	1.72	2.07	60	1.76	2.58	85	2.48	3.35					
		--	--	--	34	1.18	1.67	48	1.43	2.18	65	1.20	2.84	90	1.98	3.60					
		--	--	--	36	.94	1.78	50	1.20	2.28	70	.76	3.09	95	1.57	3.85					
		14	2.40	.89	22	3.20	1.13	34	3.40	1.63	40	4.40	1.77	60	5.00	2.53					
JPL14	Liquid Cap JL2850 + Air Cap JPD15	16	2.10	1.05	26	2.80	1.38	38	2.90	1.86	44	3.80	1.99	65	4.40	2.73	10-25	13-30	18-38	6-7	
		18	1.70	1.14	30	2.10	1.62	42	2.30	2.07	48	3.30	2.22	70	3.90	3.00					
		20	1.40	1.26	34	1.50	1.87	46	1.80	2.36	54	2.60	2.55	75	3.40	3.25					
		24	.81	1.54	38	1.20	2.10	50	1.40	2.58	60	1.90	2.98	80	3.00	3.57					
		28	.54	1.76	42	.72	2.38	60	.60	3.16	70	1.10	3.53	90	2.30	4.12					
JPLN23	Liquid Cap JL60100 + Air Cap JPD75	32	.30	1.96	48	.39	2.69	70	.33	3.65	85	.40	4.27	100	2.00	4.65	4-8	5-10	6-14	8-13	
		18	1.04	1.05	30	1.56	1.43	42	2.06	1.75	55	2.16	2.15	75	3.20	2.66					
		20	.80	1.15	34	1.10	1.61	44	1.80	1.85	60	1.60	2.38	80	2.66	2.90					
		22	.62	1.25	36	.90	1.70	46	1.57	1.94	65	1.15	2.62	85	2.19	3.13					
		24	.47	1.35	38	.74	1.79	48	1.35	2.04	70	.76	2.85	90	1.75	3.36					
JPL23B	Liquid Cap JL40100 + Air Cap JPD60	26	.35	1.45	40	.60	1.88	50	1.13	2.13	--	--	--	--	--	--	6-13	7-16	8-19	10-13	
		28	.25	1.55	42	.47	1.97	55	.70	2.36	--	--	--	--	--	--					
		--	--	--	44	.35	2.07	--	--	--	--	--	--	--	--	--					--
		14	4.50	.80	24	7.50	1.24	34	9.5	1.74	44	11.1	2.20	56	19.8	2.56					
		16	2.90	.97	26	6.00	1.44	36	7.80	1.96	46	9.7	2.46	60	16.7	2.97					
JPL23	Liquid Cap JL60100 + Air Cap JPD60	18	2.00	1.17	28	4.50	1.68	38	6.50	2.20	48	8.4	2.69	65	13.5	3.50	7-13	9-16	12-20	11-14	
		20	.84	1.42	30	3.40	1.82	40	5.20	2.53	52	5.70	3.30	70	9.7	4.33					
		--	--	--	32	2.40	2.06	42	4.10	2.65	56	3.90	3.84	80	4.80	5.73					
		--	--	--	34	1.30	2.32	46	2.60	3.25	60	2.40	4.36	90	1.80	7.40					
		--	--	--	36	.80	2.61	50	1.10	3.72	65	1.10	5.04	95	.70	8.38					
JPL43	Liquid Cap JL100150 + Air Cap JPD90	16	2.95	1.92	28	4.45	2.66	38	5.94	3.22	46	7.50	3.66	65	9.7	4.80	7-14	8-17	10-23	11-17	
		18	2.25	2.10	30	3.87	2.84	40	5.40	3.40	50	6.45	3.97	70	8.6	5.20					
		20	1.72	2.30	32	3.30	3.04	42	4.86	3.55	52	5.90	4.15	75	7.50	5.60					
		22	1.32	2.50	34	2.78	3.22	44	4.32	3.74	54	5.40	4.32	80	6.40	6.00					
		24	1.00	2.70	36	2.28	3.40	46	3.78	3.93	56	4.87	4.50	85	5.30	6.48					
JPL43	Liquid Cap JL100150 + Air Cap JPD90	--	--	--	--	--	--	48	3.25	4.12	58	4.34	4.70	90	4.25	6.96					
		--	--	--	--	--	--	--	--	--	60	3.84	4.90	--	--	--					
		12	7.00	1.15	22	11.5	1.65	34	12.4	2.20	46	13.7	2.75	65	18.3	3.56					
		14	5.40	1.35	26	8.3	2.02	38	9.8	2.57	50	10.9	3.14	75	12.6	4.47					
		16	4.20	1.57	30	6.00	2.40	42	7.80	2.95	54	8.7	3.51	80	10.6	4.95					
JPL43	Liquid Cap JL100150 + Air Cap JPD90	18	3.30	1.69	32	5.10	2.60	46	5.90	3.34	56	7.80	3.70	85	8.7	5.40					
		20	2.70	1.97	34	4.30	2.78	48	5.00	3.52	60	6.40	4.06	90	6.90	5.85					
		22	2.00	2.20	36	3.60	2.97	50	4.30	3.71	65	4.60	4.53	95	5.50	6.30					
		--	--	--	38	3.00	3.16	52	3.70	3.90	70	3.30	5.00	100	4.50	6.76					
		14	7.70	3.17	26	10.5	4.55	34	20.8	4.75	42	29.4	5.15	58	44.7	6.05					
JPL43	Liquid Cap JL100150 + Air Cap JPD90	16	5.00	3.83	28	7.00	5.15	36	16.6	5.25	44	25.1	5.60	60	41.0	6.42					
		--	--	--	--	--	--	38	12.8	5.80	46	20.8	6.05	65	31.4	7.45					
		--	--	--	--	--	--	40	9.5	6.35	48	16.7	6.60	70	22.5	8.75					
		--	--	--	--	--	--	42	6.70	6.85	50	13.1	7.15	75	15.0	10.1					
		--	--	--	--	--	--	--	--	--	52	10.0	7.75	80	8.7	11.5					
--	--	--	--	--	--	--	--	--	54	7.30	8.30	--	--	--	--	--	--	--			

"--" means not recommended at this pressure

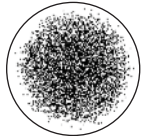

Spray Pattern

Siphon/Gravity feed

BEX JPV and JPK Spray

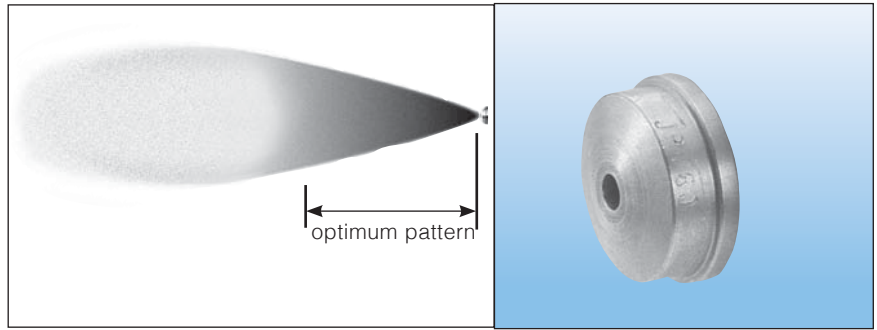

APPLICATION AND PERFORMANCE

Set-ups with BEX JPV and JPK series air caps produce round and flat spray patterns respectively. The liquid is gravity or siphon fed into the airstream. Nozzle selection is not limited for other parameters. If you do not find the product for your application, please contact BEX.

JPV Round Spray Performance Chart

BEX Set-up No.	Spray Set-up consists of Liquid and Air Cap Combination	Atomizing Air		Liquid Capacity in GPH								Spray Dimensions (at 8" siphon height)		
		Air Pressure (psi)	Air Capacity (SCFM)	Gravity Head			Siphon Height					Optimum Pattern		Max. Spray Range (feet)
				18"	12"	6"	4"	12"	24"	36"	Spray Angle (degrees)	Spray Range (inches)		
JPL1A	Liquid Cap JL1650 + Air Cap JPV20	10	.40	0.39	0.35	0.30	0.23	0.14	--	--	18	11-14	6-8	
		20	.59	0.46	0.43	0.39	0.34	0.28	0.14	--				
		40	.95	0.54	0.50	0.47	0.41	0.36	0.28	0.19				
		60	1.32	0.59	0.54	0.49	0.44	0.39	0.31	0.24				
JPL1	Liquid Cap JL2050 + Air Cap JPV20	10	.47	0.63	0.55	0.46	0.40	0.21	--	--	18-19	12-17	7-10	
		20	.66	0.73	0.66	0.60	0.54	0.4	0.21	0.07				
		40	1.06	0.87	0.81	0.76	0.71	0.61	0.43	0.28				
		60	1.48	0.98	0.92	0.88	0.83	0.73	0.57	0.40				
JPL2A	Liquid Cap JL2050 + Air Cap JPV40	10	.81	0.67	0.61	0.53	0.43	0.29	--	--	18-20	12-17	8-13	
		20	1.2	0.76	0.72	0.64	0.56	0.44	0.21	--				
		40	1.94	0.89	0.86	0.82	0.76	0.65	0.46	0.30				
		60	2.7	0.98	0.96	0.94	0.91	0.81	0.68	0.56				
JPL2	Liquid Cap JL2850 + Air Cap JPV40	10	.68	1.19	1.05	0.91	0.56	0.38	--	--	21-22	15-20	10-15	
		20	1.03	1.37	1.27	1.13	0.88	0.68	0.46	--				
		40	1.7	1.57	1.47	1.32	1.15	0.91	0.63	0.28				
		60	2.39	1.48	1.41	1.30	1.08	0.9	0.74	0.52				
JPL4	Liquid Cap JL60100 + Air Cap JPV60	20	1.9	5.8	5.2	4.20	3.10	1.9	0.6	--	17-19	18-23	12-18	
		40	3.	6.5	6.0	5.10	4.30	3	1.6	0.70				
		60	4.1	6.8	6.4	5.60	4.90	3.45	2.2	1.30				
		80	5.2	6.8	6.4	5.80	5.20	3.85	2.6	1.60				
JPL5	Liquid Cap JL100150 + Air Cap JPV80	30	5.3	--	--	--	7.20	4.6	--	--	20-22	20-25	22-27	
		40	6.5	--	--	--	7.80	5.3	--	--				
		60	8.8	--	11.4	10.6	8.3	6.2	3.2	--				
		80	11.1	11.6	11	10.3	8.3	6.4	4.4	2.2				

Spray Pattern

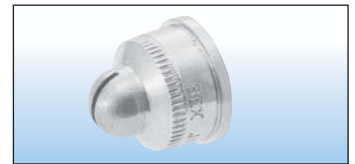

JPK Flat Spray Performance Chart

BEX Set-up No.	Spray Set-up consists of Liquid and Air Cap Combination	Atomizing Air		Liquid Capacity in GPH								Spray Dimensions (at 8" siphon height)			
		Air Pressure (psi)	Air Capacity (SCFM)	Gravity Head			Siphon Height					Optimum Pattern			Max. Spray Range Feet
				18"	12"	6"	4"	8"	12"	24"	36"	6" from tip	9" from tip	15" from tip	
JPLF1	Liquid Cap JL2850 + Air Cap JPK20	10	.99	0.35	0.33	0.30	0.27	0.25	0.22	0.17	0.13	8-9	10-12	15	6-7
		20	1.42	0.31	0.30	0.29	0.26	0.25	0.23	0.19	0.16				
		30	1.83	0.18	0.16	0.15	0.11	0.09	--	--	--				
JPLF2C	Liquid Cap JL35100 + Air Cap JPK40	20	1.86	1.01	0.95	0.90	0.77	0.72	0.67	0.62	0.56	9-11	12-15	15-19	9-10
		30	2.42	0.88	0.84	0.81	0.75	0.71	0.67	0.63	0.57				
		40	2.96	0.76	0.73	0.69	0.65	0.61	0.58	0.53	0.48				
		60	4.05	0.44	0.41	0.37	0.33	0.30	0.27	--	--				
JPLF3B	Liquid Cap JL40100 + Air Cap JPK60	20	2.26	1.35	1.28	1.20	1.01	0.96	0.92	0.78	0.62	7-8	9-10	10-12	10-11
		30	2.88	1.26	1.21	1.14	0.92	0.87	0.82	0.74	0.59				
		40	3.52	0.98	0.92	0.87	0.66	0.59	0.52	0.44	--				
		50	4.13	0.58	0.52	0.44	--	--	--	--	--				
JPLF4B	Liquid Cap JL40100 + Air Cap JPK80	20	2.1	2.01	1.90	1.71	1.47	1.40	1.32	1.17	0.92	6-8	8-10	10-13	11
		30	2.7	2	1.94	1.81	1.58	1.52	1.45	1.34	1.11				
		40	3.28	1.82	1.74	1.63	1.42	1.34	1.22	1.03	--				
		50	3.87	1.1	0.97	0.85	0.69	--	--	--	--				

"--" means not recommended at this pressure

BEX JPT Series Flat Spray

Pressure feed - External mix

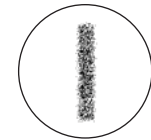
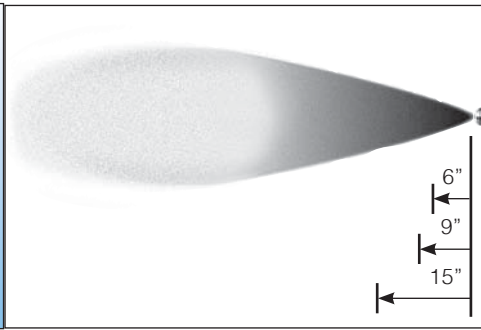
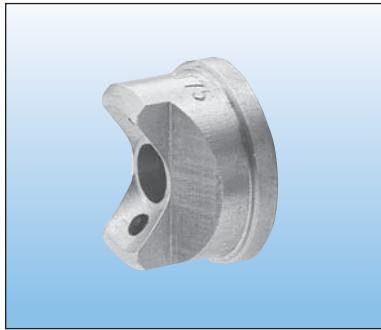

Spray Pattern

APPLICATION AND PERFORMANCE

BEX JPT series air caps produce a flat spray pattern. Liquid is pressure fed and externally mixed. Nozzle selection is not limited for other parameters. If you do not find the product for your application range, please contact BEX.

JPT Flat Spray Performance Chart

BEX Set-up No.	Spray Set-up consists of Liquid and Air Cap Combination	Liquid Capacity in GPH and Air Capacity in SCFM															Spray Dimensions (in)									
		Liquid Pressure in psi															Optimum Pattern			Maximum Spray Range Feet						
		3 psi			5 psi			10 psi			20 psi			40 psi			6" from tip	9" from tip	15" from tip							
Air Press psi	SCFM	GPH	Air Press psi	SCFM	GPH	Air Press psi	SCFM	GPH	Air Press psi	SCFM	GPH	Air Press psi	SCFM	GPH	Air Press psi	SCFM	GPH									
JPLE15B	Liquid Cap JL1650 Air Cap JPT15	3	.89	.80	5	.93	1.1	10	1.1	1.4	20	1.6	2.0	40	2.6	2.8	3-6	6-7	9-11	3-8						
		5	.93	.80	10	1.1	1.0	15	1.4	1.4	25	1.9	2.0	50	3.0	2.8										
		10	1.1	.80	15	1.4	1.0	20	1.6	1.4	30	2.1	2.0	60	3.6	2.8										
		15	1.4	.80	20	1.6	1.0	25	1.9	1.4	40	2.6	2.0	70	4.2	2.8										
		20	1.6	.80	25	1.9	1.0	30	2.1	1.4	50	3.0	2.0	75	4.5	2.8										
		25	1.9	.80	30	2.1	1.0	40	2.6	1.4	60	3.6	2.0	80	4.9	2.8										
JPLE18B	Liquid Cap JL1650 Air Cap JPT30	5	.78	.80	5	.78	1.0	6	.88	1.4	8	1.0	2.0	10	1.2	2.8	8-12	11-15	13-20	4-9						
		6	.88	.80	6	.88	1.0	8	1.0	1.4	10	1.2	2.0	15	1.6	2.8										
		7	.97	.80	8	1.0	1.0	10	1.2	1.4	15	1.6	2.0	25	2.2	2.8										
		8	1.0	.80	10	1.2	1.0	12	1.4	1.4	20	1.9	2.0	35	2.8	2.8										
		JPLE15A	Liquid Cap JL2050 Air Cap JPT15	5	.93	1.2	10	1.1	1.6	15	1.4	2.2	25	1.9	3.1	45					2.9	4.4	3-6	5-8	8-12	3-10
				10	1.1	1.2	15	1.4	1.6	20	1.6	2.2	30	2.1	3.1	50					3.0	4.4				
15	1.4			1.2	20	1.6	1.6	25	1.9	2.2	40	2.6	3.1	60	3.6	4.4										
20	1.6			1.2	25	1.9	1.6	30	2.1	2.2	50	3.0	3.1	70	4.2	4.4										
25	1.9			1.2	30	2.1	1.6	40	2.6	2.2	60	3.6	3.1	75	4.5	4.4										
30	2.1			1.2	40	2.6	1.6	50	3.0	2.2	70	4.2	3.1	90	5.6	4.4										
JPLE18A	Liquid Cap JL1650 Air Cap JPT30	5	.78	1.2	5	.78	1.6	8	1.0	2.2	10	1.2	3.1	15	1.6	4.4	11-16	13-19	16-26	5-10						
		8	1.0	1.2	10	1.2	1.6	10	1.2	2.2	20	1.9	3.1	20	1.9	4.4										
		10	1.2	1.2	15	1.6	1.6	20	1.9	2.2	30	2.5	3.1	30	2.5	4.4										
		15	1.6	1.2	20	1.9	1.6	30	2.5	2.2	35	2.8	3.1	35	2.8	4.4										
		JPLE15	Liquid Cap JL2850 Air Cap JPT15	10	1.1	2.3	15	1.4	3.0	20	1.6	4.2	35	2.4	6.0	50					3.0	8.4	5-6	6-8	9-14	4-13
				15	1.4	2.3	20	1.6	3.0	25	1.9	4.2	40	2.6	6.0	60					3.6	8.4				
20	1.6			2.3	25	1.9	3.0	30	2.1	4.2	50	3.0	6.0	70	4.2	8.4										
25	1.9			2.3	30	2.1	3.0	40	2.6	4.2	60	3.6	6.0	75	4.5	8.4										
30	2.1			2.3	40	2.6	3.0	50	3.0	4.2	70	4.2	6.0	80	4.9	8.4										
40	2.6			2.3	50	3.0	3.0	60	3.6	4.2	80	4.9	6.0	90	5.6	8.4										
JPLE18	Liquid Cap JL2850 Air Cap JPT30	6	.88	2.3	6	.88	3.0	6	.88	4.2	10	1.2	6.0	20	1.9	8.4	14-17	19-21	24-27	6-9						
		7	.97	2.3	8	1.0	3.0	8	1.0	4.2	12	1.4	6.0	25	2.2	8.4										
		8	1.0	2.3	9	1.1	3.0	10	1.2	4.2	15	1.6	6.0	30	2.5	8.4										
		10	1.2	2.3	10	1.2	3.0	12	1.4	4.2	20	1.9	6.0	35	2.8	8.4										
JPLE25B	Liquid Cap JL35100 Air Cap JPT45	10	3.0	3.6	15	3.6	4.7	20	4.1	6.6	35	6.3	9.4	45	7.5	13.2	5-6	7-9	10-14	5-16						
		15	3.6	3.6	20	4.1	4.7	25	4.9	6.6	40	6.9	9.4	50	8.2	13.2										
		20	4.1	3.6	25	4.9	4.7	30	5.5	6.6	50	8.0	9.4	55	9.0	13.2										
		25	4.9	3.6	30	5.5	4.7	35	6.3	6.6	60	9.4	9.4	60	9.7	13.2										
		30	5.5	3.6	40	6.9	4.7	40	6.9	6.6	70	11.0	9.4	70	11.1	13.2										
		40	6.9	3.6	50	8.0	4.7	50	8.0	6.6	80	12.7	9.4	80	12.7	13.2										
50	8.0	3.6	60	9.4	4.7	60	9.4	6.6	90	14.5	9.4	90	14.5	13.2												

Pressure feed - External mix

BEX JPT Series Flat Spray

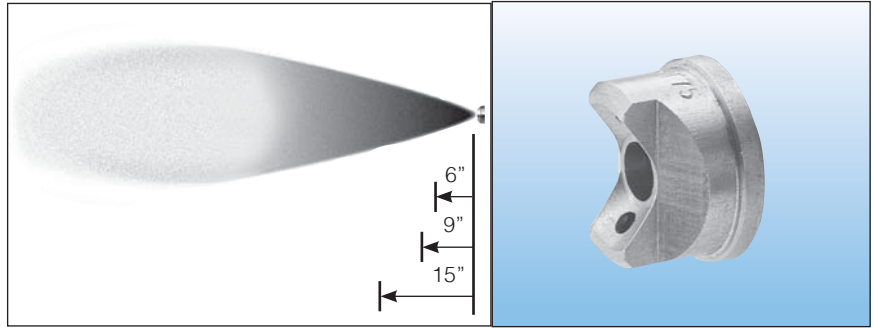
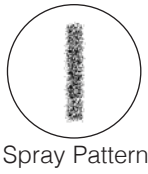

APPLICATION AND PERFORMANCE

BEX JPT series air caps produce a flat spray pattern. Liquid is pressure fed and externally mixed. Nozzle selection is not limited for other parameters. If you do not find the product for your application range, please contact BEX.

JPT Flat Spray Performance Chart (continued)

BEX Set-up No.	Spray Set-up consists of Liquid and Air Cap Combination	Liquid Capacity in GPH and Air Capacity in SCFM															Spray Dimensions (in)			
		Liquid Pressure in psi															Optimum Pattern			Maximum Spray Range Feet
		3 psi			5 psi			10 psi			20 psi			40 psi			6" from tip	9" from tip	15" from tip	
Air Press psi	SCFM	GPH	Air Press psi	SCFM	GPH	Air Press psi	SCFM	GPH	Air Press psi	SCFM	GPH	Air Press psi	SCFM	GPH	Air Press psi	SCFM	GPH			
JPLE28B	Liquid Cap JL35100 Air Cap JPT60	8	3.2	3.6	10	3.6	4.7	20	5.5	6.6	30	7.4	9.4	60	12.6	13.2	13-16	15-20	19-28	12-17
		10	3.6	3.6	15	4.6	4.7	30	7.4	6.6	40	9.1	9.4	60	12.6	13.2				
		15	4.6	3.6	25	6.5	4.7	35	8.3	6.6	50	10.9	9.4	75	15.2	13.2				
		20	5.5	3.6	30	7.4	4.7	40	9.1	6.6	60	12.6	9.4	80	16.0	13.2				
JPLE25A	Liquid Cap JL40100 Air Cap JPT45	10	3.0	4.8	20	4.1	6.1	25	4.9	8.7	40	6.9	12.3	50	8.2	17.4	6-7	7-10	10-14	7-19
		15	3.6	4.8	25	4.9	6.1	30	5.5	8.7	45	7.5	12.3	60	9.7	17.4				
		20	4.1	4.8	30	5.5	6.1	35	6.3	8.7	50	8.0	12.3	70	11.1	17.4				
		25	4.9	4.8	35	6.3	6.1	40	6.9	8.7	60	9.4	12.3	75	12.0	17.4				
		30	5.5	4.8	40	6.9	6.1	50	8.0	8.7	70	11.0	12.3	80	12.7	17.4				
		40	6.9	4.8	50	8.0	6.1	60	9.4	8.7	80	12.7	12.3	90	14.5	17.4				
JPLE28A	Liquid Cap JL40100 Air Cap JPT60	8	3.2	4.8	10	3.6	6.1	15	4.6	8.7	35	8.3	12.3	50	10.9	17.4	12-15	15-19	20-25	10-17
		15	4.6	4.8	20	5.5	6.1	25	6.5	8.7	45	10.0	12.3	65	13.5	17.4				
JPLE28	Liquid Cap JL60100 Air Cap JPT60	10	3.6	9.9	15	4.6	6.1	25	6.5	18.0	45	10.0	25.5	75	15.2	36.0	15-19	20-25	26-33	12-19
		15	4.6	9.9	20	5.5	6.1	30	7.4	18.0	50	10.9	25.5	85	16.8	36.0				
		20	5.5	9.9	30	7.4	6.1	40	9.1	18.0	70	14.3	25.5	95	18.5	36.0				
		25	6.5	9.9	35	8.3	6.1	45	10.0	18.0	80	16.0	25.5	100	19.4	36.0				
JPLE25	Liquid Cap JL60100 Air Cap JPT45	15	3.6	9.9	25	4.9	12.7	35	6.3	18.0	45	7.5	25.5	55	9.0	36.0	6-8	8-11	10-15	9-19
		20	4.1	9.9	30	5.5	12.7	40	6.9	18.0	50	8.0	25.5	60	9.7	36.0				
		25	4.9	9.9	35	6.3	12.7	45	7.5	18.0	55	8.7	25.5	65	10.5	36.0				
		30	5.5	9.9	40	6.9	12.7	50	8.0	18.0	60	9.4	25.5	70	11.1	36.0				
		35	6.3	9.9	45	7.5	12.7	60	9.4	18.0	70	11.0	25.5	80	12.7	36.0				
		40	6.9	9.9	50	8.0	12.7	70	11.0	18.0	80	12.7	25.5	90	14.5	36.0				
JPLE45B	Liquid Cap JL60150 Air Cap JPT75	25	8.3	10.0	25	8.3	12.9	35	10.5	18.0	55	14.5	25.5	--	--	--	6-7	8-9	11-13	10-18
		30	9.2	10.0	30	9.2	12.9	40	11.6	18.0	60	15.7	25.5	--	--	--				
		35	10.5	10.0	35	10.5	12.9	45	12.5	18.0	65	17.0	25.5	--	--	--				
		40	11.6	10.0	40	11.6	12.9	50	13.4	18.0	70	18.4	25.5	--	--	--				
		45	12.5	10.0	45	12.5	12.9	55	14.5	18.0	75	20.0	25.5	--	--	--				
		50	13.4	10.0	50	13.4	12.9	60	15.7	18.0	80	21.2	25.5	--	--	--				
JPLE45A	Liquid Cap JL80150 Air Cap JPT75	30	9.2	17.4	40	11.6	22.5	55	14.5	31.5	70	18.4	44.7	--	--	--	6-8	9-10	13-15	11-20
		35	10.5	17.4	45	12.5	22.5	60	15.7	31.5	75	20.0	44.7	--	--	--				
		40	11.6	17.4	50	13.4	22.5	65	17.0	31.5	80	21.2	44.7	--	--	--				
		45	12.5	17.4	55	14.5	22.5	70	18.4	31.5	85	22.5	44.7	--	--	--				
		50	13.4	17.4	60	15.7	22.5	75	20.0	31.5	90	24.2	44.7	--	--	--				
		60	15.7	17.4	70	18.4	22.5	80	21.2	31.5	--	--	--	--	--	--				
JPLE45	Liquid Cap JL100150 Air Cap JPT75	40	11.6	27.9	50	13.4	36.0	65	17.0	50.6	80	21.2	72.0	--	--	--	7-8	10-11	14-16	15-20
		45	12.5	27.9	55	14.5	36.0	70	18.4	50.6	85	22.5	72.0	--	--	--				
		50	13.4	27.9	60	15.7	36.0	75	20.0	50.6	90	24.2	72.0	--	--	--				
		55	14.5	27.9	65	17.0	36.0	80	21.2	50.6	--	--	--	--	--	--				
		60	15.7	27.9	70	18.4	36.0	85	22.5	50.6	--	--	--	--	--	--				
		65	17.0	27.9	75	20.0	36.0	90	24.2	50.6	--	--	--	--	--	--				
70	18.4	27.9	80	21.2	36.0	--	--	--	--	--	--	--	--	--	--					

“--” means not recommended at this pressure

Alternative Bodies (Connections) and Mounting

For specific application details, please contact BEX.

Top-Connect Body



2JTPL - 1/4" Top-Connect JPL Body
Air (gas) and liquid inlets are both on top of this body, 90° from the nozzle outlet.

Back-Connect Body



2JBPL - 1/4" Back-Connect JPL Body
Air (gas) and liquid inlets are on back of this body, 180° from the nozzle outlet.

Thick Wall Mount



JPLM -
Wall adapter replaces the cap retaining ring with a 3/4" MNPT adapter which allows mounting any JPL assembly to a thick wall (over 3/8" thick).

Thin Wall Mount



JPLN -
Thin wall adaptation, simply add a PLMN locking nut and PLMG o-ring to the JPLM thick wall adapter, and you can mount any JPL assembly to a wall less than 3/8" thick.

(1-1/16" clearance hole required)

Rod Mounting Bracket

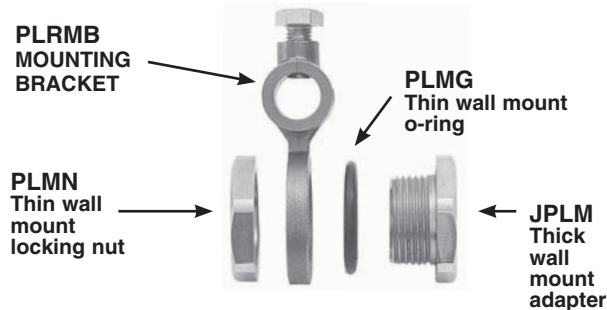

PLRMB -
The rod mounting bracket allows for any air atomizing body to be mounted to a 1/2" diameter steel rod. Simply use the hardware from the thin wall mount (JPLN).

BEX Automatic Air Actuated Spray Nozzles can be fitted with any BEX spray set-ups to meet your atomizing needs. Liquid flow to the nozzle assembly may be either pressure, gravity or siphon fed. The flow is precisely controlled through an automatically operated air cylinder inside the body. For specific application details please contact BEX. Typical applications include: moistening, die lubrication, coatings, pattern lubrication, paper mills, and many others.

Automatic Air Actuated Nozzle Body Assemblies



Standard Automatic Body

2JAPL -

Automatic Body



2JAFPL -

Automatic Body with Manual Shut-off



Single Airline Automatic Body

2JSPL -

Single Air Line Automatic Body



2JSFPL -

Single Air Line Automatic Body with Manual Shut-off



Extensions (For JA Series Body)

2JAX6PL - 6" Extension

2JAX12PL - 12" Extension

These extensions allow the spray tip to be positioned 6" or 12" away from the body.

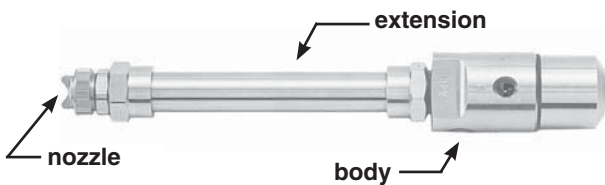

Extensions (For JPL, JTPL, JBPL Series Body)

JX6PL - 6" Extension
JX12PL - 12" Extension

These extensions allow the spray tip to be positioned 6" or 12" away from the body.

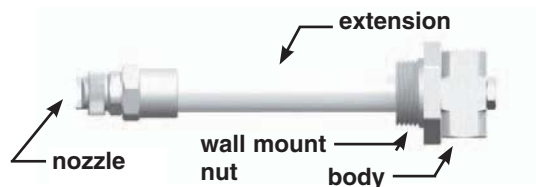

AIR ATOMIZING

How to Order

We have designed these two pages to help you select a model number for easy ordering. If you would like help in choosing the proper assembly to order, please give us a call and we will be happy to assist you.

To order any JPL assembly choose from the following:

FITTING CODE	
Code	Description
2	1/4" x 1/4" NPT
B2	1/4" x 1/4" BSPT

Note: 1/8" NPT and BSPT are available. Contact BEX for ordering information.

BODY CODE	
Code	Description
STANDARD BODIES	
JPL	Standard Body
JTPL	Top-Connect Body
JBPL	Back-Connect Body
JMPL	Thick Wall
JNPL	Thin Wall
JX6PL	6" Extension
JX12PL	12" Extension
AUTOMATIC AIR-ACTUATED BODIES	
JAPL	Automatic Body
JAFPL	Automatic/with Shut-Off
JSPL	Single-Airline Automatic
JSFPL	Single-Air/with Shut-Off
JAX6PL	6" Extended-Automatic
JAX12PL	12" Extended-Automatic

Examples of JPL assembly model numbers.

FITTING CODE	BODY CODE	SET-UP CODE	OPTION CODES*	MATERIAL CODE
2	JPL	12		3
2JPL12 3, is a standard JPL assembly consisting of: 1/4" x 1/4" NPT fitting standard JPL body; knurled retaining ring, rear plug, fiber gasket and fiber washer; JPE40 air cap and JL2850 liquid nozzle in 303 stainless steel.				
2	JSPL	12	T	6
2JSPL12T 6, is a single airline automatic JPL assembly consisting of: 1/4" x 1/4" NPT fitting single airline automatic JSPL body; knurled retaining ring; and Teflon® gasket; JPE40 air cap and JL2850 liquid nozzle in 316 stainless steel.				

Note: When ordering always leave a space between the model number and material code. Example: 2JPL12 3

SET-UP CODE	
Code (pages 4-9)	Description
11, 12A, 12, 22B, 22, 42	Internal Mix, Round
16, 26B, 30, 26, 29, 46	Internal Mix, Wide-Angle, Round
13A, 13, N13, 14, 23B, N23, 23, 43	Internal Mix, Flat
1A, 1, 2A, 2, 4, 5	Siphon, Round
F1, F2C, F3B, F4B	Siphon, Flat
E15B, E18B, E15A, E18A, E15, E18, E25B, E28A, E28A, E28A, E25, E28, E45B, E45A, E45	External, Flat

OPTION CODES*	
Code	Description
H	Hex Retaining Ring
T	Teflon® Gasket & Washer
C	Clean-out Assembly**
F	Flow Control (Shut-off)**
S	Shut-off and Clean-out (for standard bodies only)**

MATERIAL CODE	
Code	Description
3	303 Stainless
6	316 Stainless
NP	Nickel-Plated Brass

Note: Although nickel-plated brass assembly appears to be all nickel when assembled, only the exterior surfaces of brass component are nickel-plated - see comparison below.

Teflon® is a registered Trademark of The DuPont Corporation.

* Use Option Codes only where applicable.

** Shut-off and Clean-out options are not applicable to the Back-Connect body.

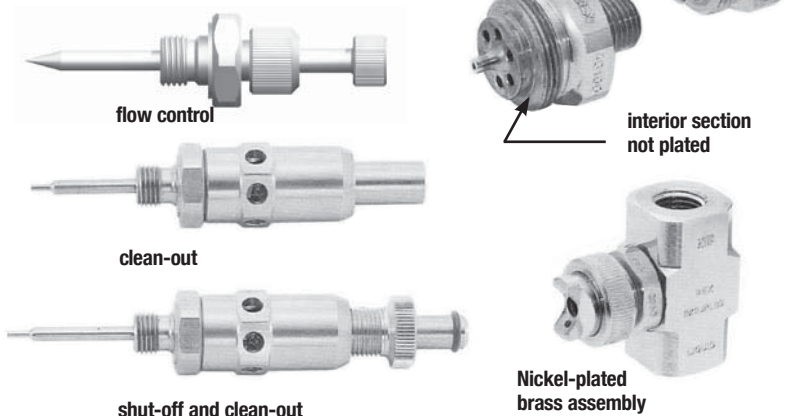

AIR ATOMIZING

Threaded Nozzles

Flat Spray

FV low flow flat "V" 12
 F flat "V" 15
 F 5 degree 21
 F solid stream 22
 F flat "V" molded plastic 23
 Air blow-off 24
 STF flat "V" 25
 DF flat "V" 25
 FL flooding 27
 FL with air & steam 28
 FP high impact 29

Full Cone Spray

S full cone 30
 SW wide angle full cone 31
 SQ full square spray 32
 SWSQ full square wide angle spray 33
 S30 narrow angle 34
 S15 narrow angle 34
 S molded plastic 35
 YS twister® 37
 HNS vaneless full cone 38
 CCS full cone 39
 FS full cone (larger sizes) 40
 PS, PSW plastic full cone 41
 PSQ, PSWSQ plastic full square spray 42

Hollow Cone Spray

H hollow cone 43
 HW wide angle hollow cone 44
 PH phosphating hollow cone 44
 YH twister® 45
 ILH in-line hollow cone 46
 C hydraulic atomizing 47
 CW wide angle hydraulic atomizing 48
 R high capacity hollow cone 49

Quick-Disconnect Nozzles

Zip-Tips®

Metal

Z Bodies and adaptors 51
 ZF flat "V" 52
 ZF solid stream 55
 ZFP high impact 56
 ZFL flooding 57
 ZFL with air & steam 58
 ZS full cone 59
 ZSW wide angle full cone 60
 ZSQ full square spray 61
 ZWSQ full square wide angle spray 62
 ZHNS vaneless full cone 62
 ZH hollow cone 63
 ZHW wide angle hollow cone 64
 ZPH phosphating hollow cone 64

Plastic

Z Bodies and adaptors 65
 ZF flat "V" 66
 ZS full cone 68

K-Ball® Clip-On Nozzles

BF flat "V" 70
 BFL flooding 71
 BPH phosphating hollow cone 71
 KB shut off ball 71
 KZ adaptors 72
 Threaded balls 72
 Conversion o-ring 72
 Threaded bodies 73

Other Nozzles

Tank mixing eductors 75
 TWA tank washing assemblies 77
 M7S cluster nozzles 77
 M7C Series 78
 TWK keg washing nozzles 79
 WF disc style flat "V" shower nozzles 81
 WA self-cleaning nozzles 82
 WN solid stream nozzles 82
 Ruby orifice nozzles 83
 MAJ retaining cap style adjustable joints 84
 AJ flange style adjustable joints 84
 K-Ball® clip-on as adjustable joints 84
 SN4224 85
 Check valves 85
 Split eyelets 85
 STA flow straighteners 86
 AW Airwisk® air blow-off 86
 SN4922 CIP nozzle 86

Air Atomizing Nozzles

JPE round spray 92
 JPG wide angle round spray 93
 JPD flat spray 94
 JPV round spray (siphon/gravity setup) 95
 JPK flat spray (siphon/gravity setup) 95
 JPT flat spray 96
 JPL body styles 98
 JPL automatic body styles 99
 JPL extensions 99

NEW PRODUCTS



Mini Eductor

Molded TWK

EFP

JTH

All nozzle specifications subject to change without prior notice.

Terms and Conditions of Sale

(1) WARRANTIES

Seller warrants that its products will conform to and perform substantially in accordance with the products' specification.

Seller warrants that the product do not infringe upon any copyright, patent, or trademark.

(2) WARRANTY DISCLAIMER, LIMITATION OF LIABILITY

THE WARRANTIES STATED IN SECTION 1 ABOVE ARE EXCLUSIVE AND IN LIEU OF ALL OTHER WARRANTIES, EXPRESSED OR IMPLIED, INCLUDING ANY IMPLIED WARRANTY OF MERCHANTABILITY OR FITNESS FOR A PARTICULAR PURPOSE. SELLER SHALL NOT BE LIABLE FOR ANY SPECIAL, INCIDENTAL OR CONSEQUENTIAL DAMAGES, EVEN IF INFORMED OF THE POSSIBILITY THEREOF IN ADVANCE. THIS EXCLUSION OF LIABILITY FOR SPECIAL, INCIDENTAL OR CONSEQUENTIAL DAMAGES SHALL APPLY TO ALL CAUSES OF ACTION INCLUDING WITHOUT

LIMITATION BREACH OF CONTRACT, BREACH OF WARRANTY, NEGLIGENCE, STRICT LIABILITY, MISREPRESENTATION AND ANY OTHER CAUSE OF ACTION BASED UPON SIMILAR OR DISSIMILAR LEGAL THEORIES.

(3) TECHNICAL ASSISTANCE

Unless otherwise expressly stated by Seller: (a) any technical advice provided by Seller with respect to the use of goods furnished to Buyer shall be without charge; (b) Seller assumes no obligation or liability for any such advice, or for any results occurring as a result of the application of such advice; and (c) Buyer shall have sole responsibility for selection and specification of the goods appropriate for the end use of such goods.

(4) PATENTS

The Seller shall not be liable for any costs or damages incurred by the Buyer that are based in whole or part on claims (a) that the use of any products, or any part thereof, furnished hereunder in combination with products not supplied by the Seller or (b) that a manufacturing or other process utilizing any product, or any part thereof furnished hereunder, constitutes either direct or contributor infringement of any patent of the United States.

The Buyer shall hold the Seller harmless against any expense or loss resulting from infringement of patents, copyrights trademarks, or other proprietary rights of a third party arising from Seller's compliance with Buyer's designs or specifications or instructions.

BEX Engineering Celebrates Over 50 Years in Business

As we celebrate our 51st anniversary, we want to thank you our customers for your support over the years. Please visit our completely new website at www.bex.com

“Our new website features thousands of spray nozzles in stock and an expanded engineering section to help with your spray nozzle selection.” Says Derek Bowen, President of BEX Engineering Ltd. “As part of our ongoing efforts to continually improve our level of customer satisfaction, we have added more equipment to even further improve our manufacturing processes.”

What does this mean for you?

The fastest deliveries in the industry for spray nozzles and tank mixing eductors just got faster! Most orders placed by 4PM EDT receive next day delivery!



If you don't see what you are looking for, contact your BEX representative today.



CANADA:

BEX Engineering Limited
5115 Timberlea Blvd.
Mississauga, ON L4W2S3

(905) 238-8920 Phone
(905) 238-8955 Fax



UNITED STATES:

BEX, Inc.
836 Phoenix Drive
Ann Arbor, MI 48108

(734) 389-0464 Phone
(734) 389-0470 Fax



EUROPE:

BEX GmbH
Siemensring 44N
D-47877 Willich
Deutschland

49 2154/88 70 06 Phone
49 2159/88 70 06 Fax

